

The LBW CAL Switch chassis was pulled from the dome on Friday 4 April 2008 in order to investigate a complaint that newly-figured CAL values disagreed with earlier values by large amounts, in some cases by 3 dB or so. This discrepancy was frequency dependent, with the largest differences seen near the high end of the band.

Our concern was that one or more RF components in the chassis was acting up, most likely a switch or a flaky connection, and tests were performed to see if there was any evidence of abnormal behavior of the RF components in the box.

Unfortunately, in his enthusiasm, the investigator (me) did not think to make measurements prior to performing a round of going around and tightening all the RF connectors. But a fair number of the connectors were slightly looser than proper torque, and two or three were seriously loose.

The tests whose results are shown in the following pages were performed by connecting a 3-port VNA to the CAL chassis. VNA port one was connected in place of one or the other of the two noise sources, VNA port 2 was connected to the 'A' CAL out, and VNA port 3 was connected to the 'B' CAL out.

Calibrated VNA data was stored in CitiFile (.cti) format, under filenames which give indications of the CAL level (H or L), which noise source (A or B) was being "replaced" by the VNA signal, and which CAL mode (0, 1, 2, or 3) was selected (per the following table):

Cal mode	Description
0	CORR
1	XCAL
2	CAL
3	90 deg

For example, the file 'LA2.cti' contains data with the low CAL level selected and the VNA substituting for noise source 'A', in mode 2 (just plain 'CAL'). In this mode the A noise source feeds the CAL A output, and the B source feeds the CAL B output. So in this particular file the A output is active and the B output has nothing on it.

The data from the CitiFiles was copied into various spreadsheets and the relevant calculations and plots were done in the spreadsheets. Finally the plots were printed in PDF form and assembled into the document you are now reading.

CONCLUSION:

It appears that nothing bad is going on beyond ordinary RF component tolerances.

Transmission from Noise source A, to A & B CAL outputs HCORCAL

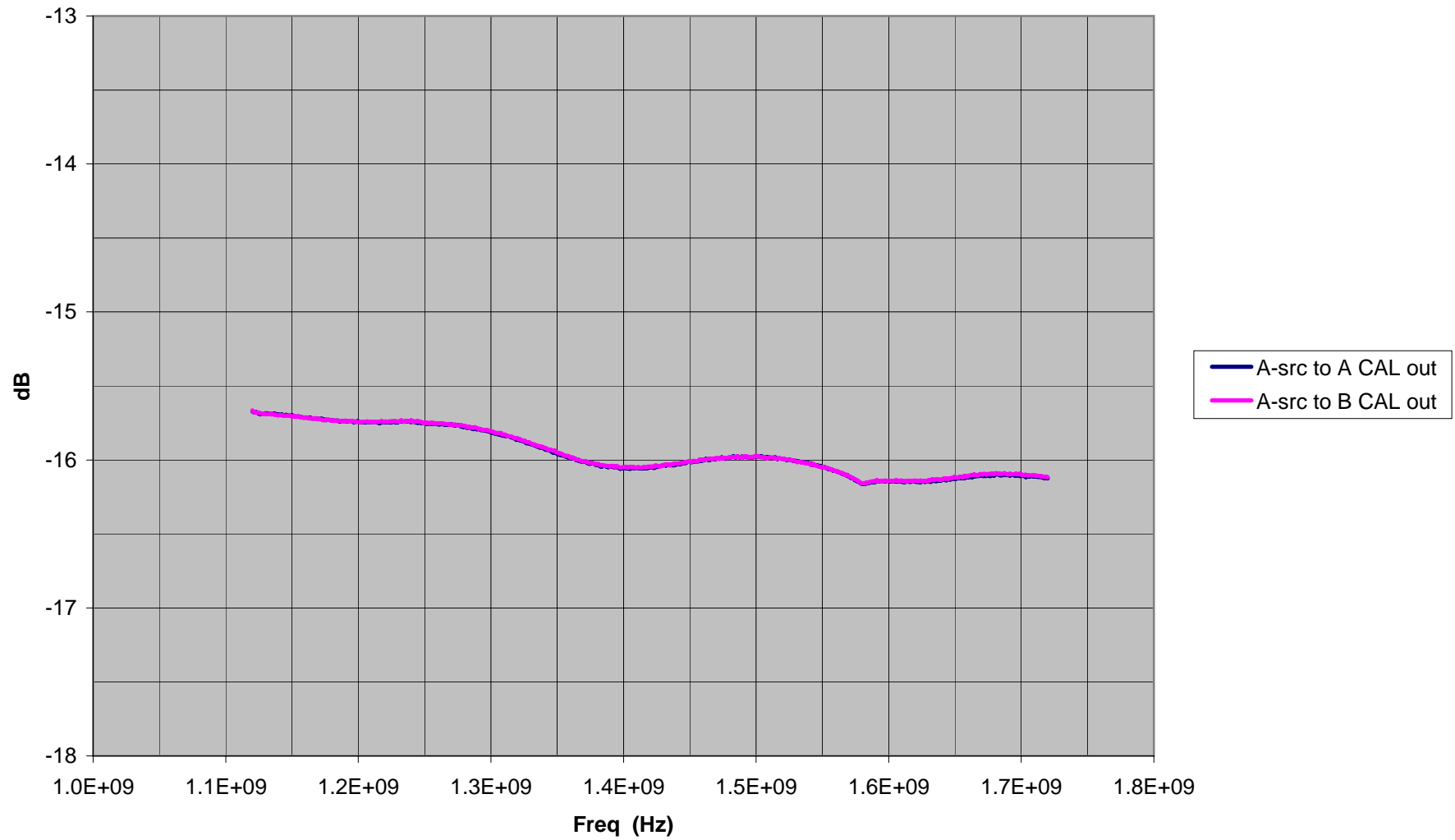

Transmission from Noise source A, to A & B CAL outputs LCORCAL

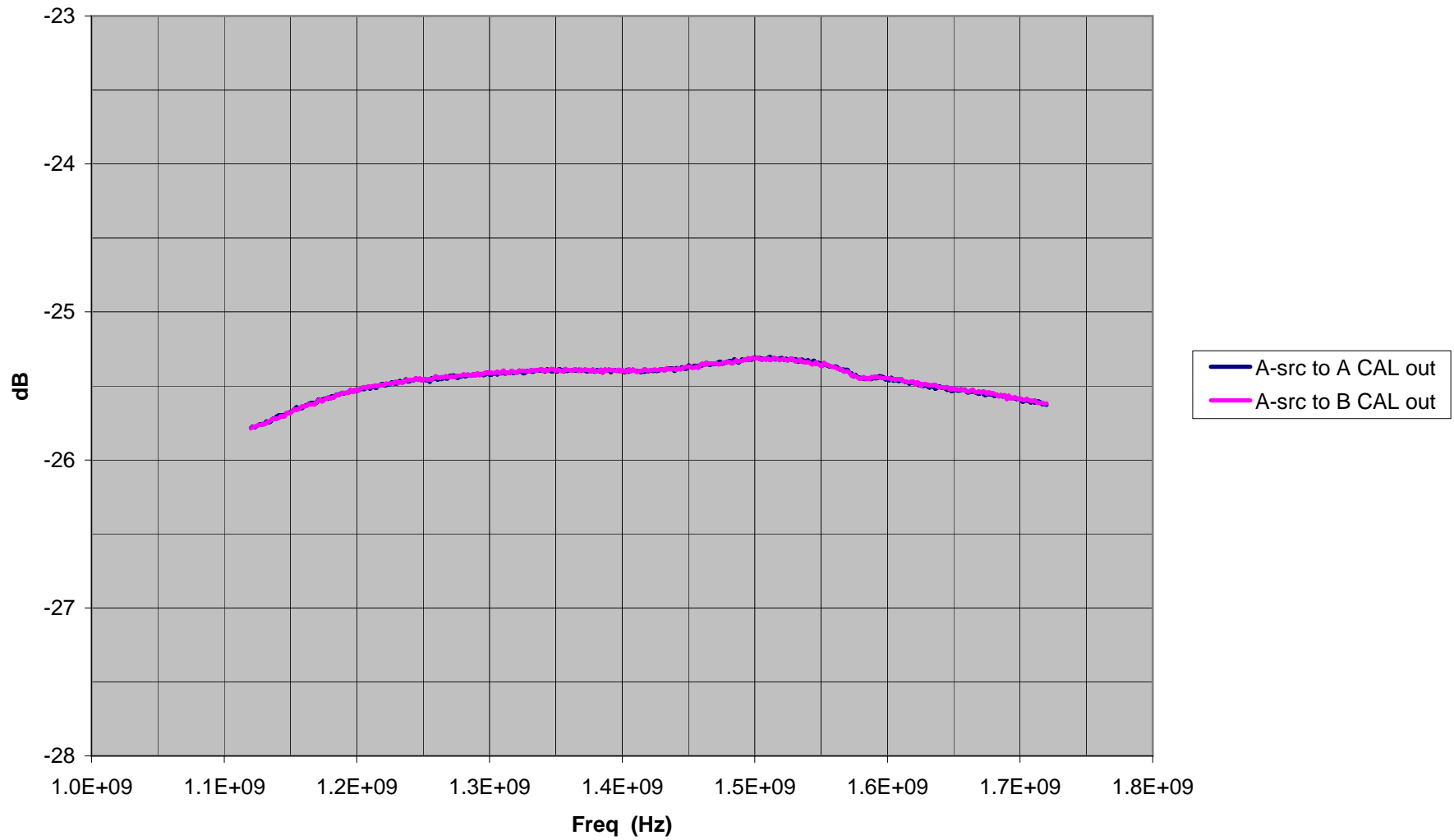

Angl(Bout/Aout): driven by source A
HCORCAL

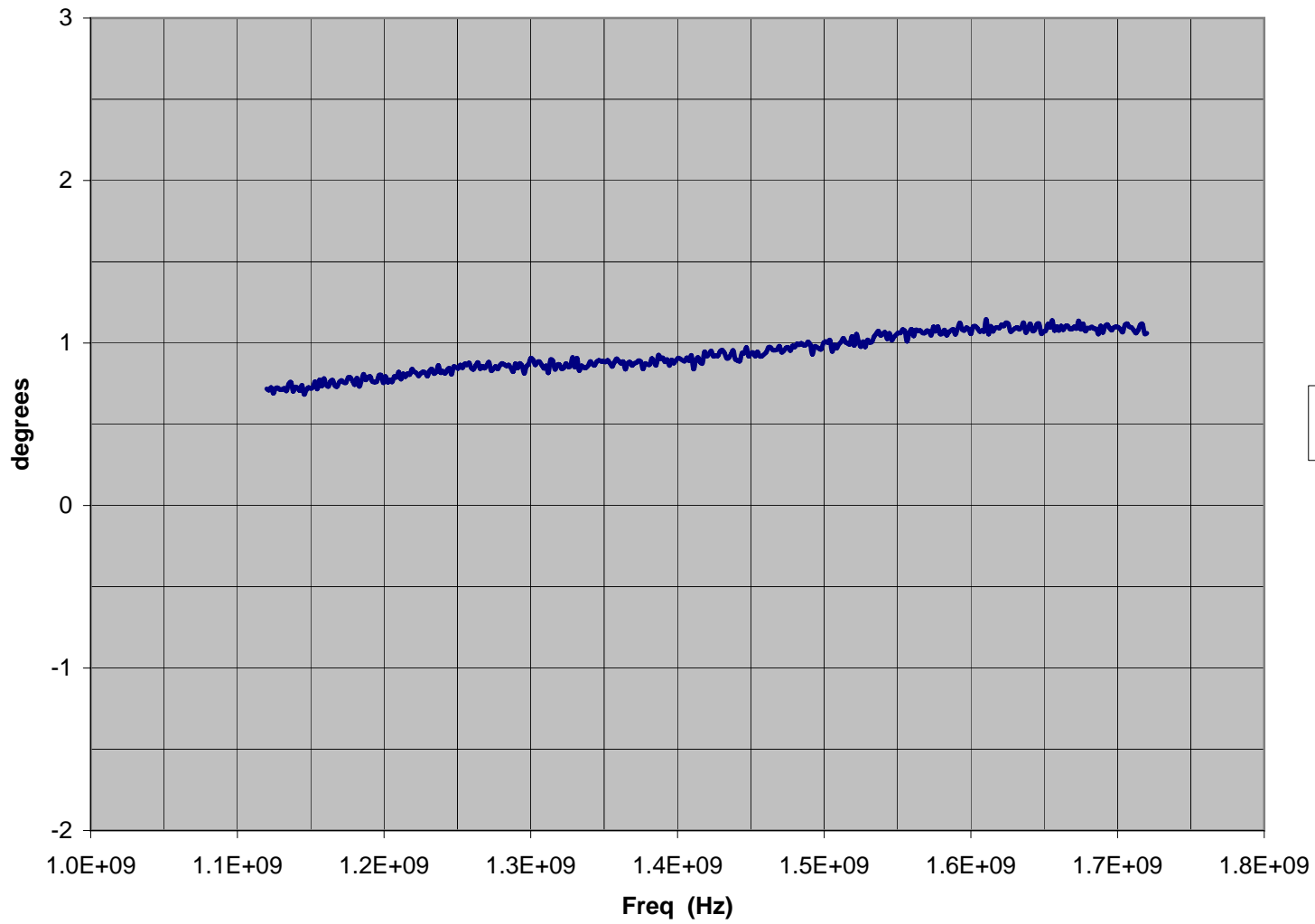

Angl(Bout/Aout): driven by source A
LCORCAL

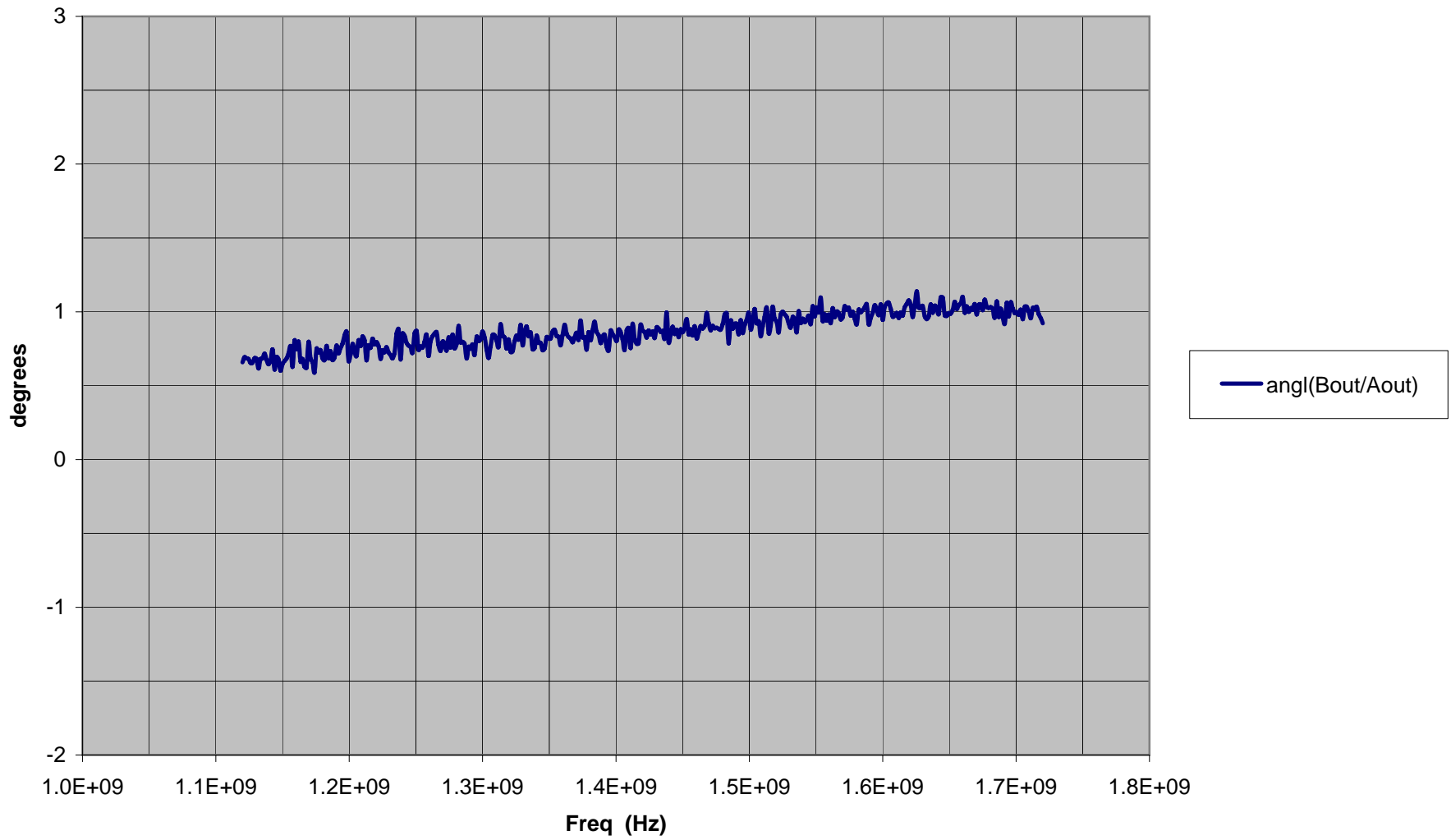

Magn(Bout/Aout): driven from source A
HCORCAL

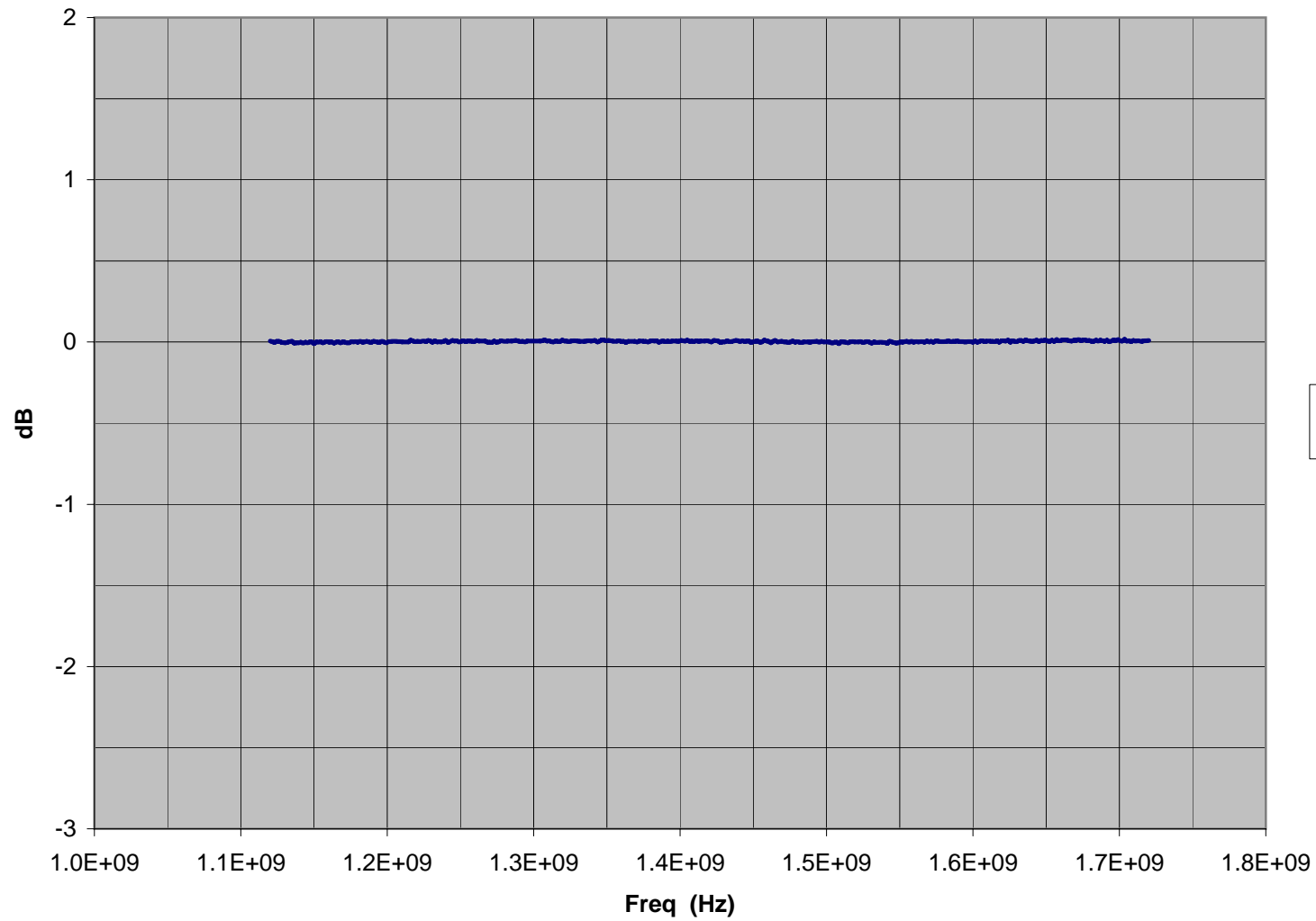

Magn(Bout/Aout): driven from source A
LCORCAL

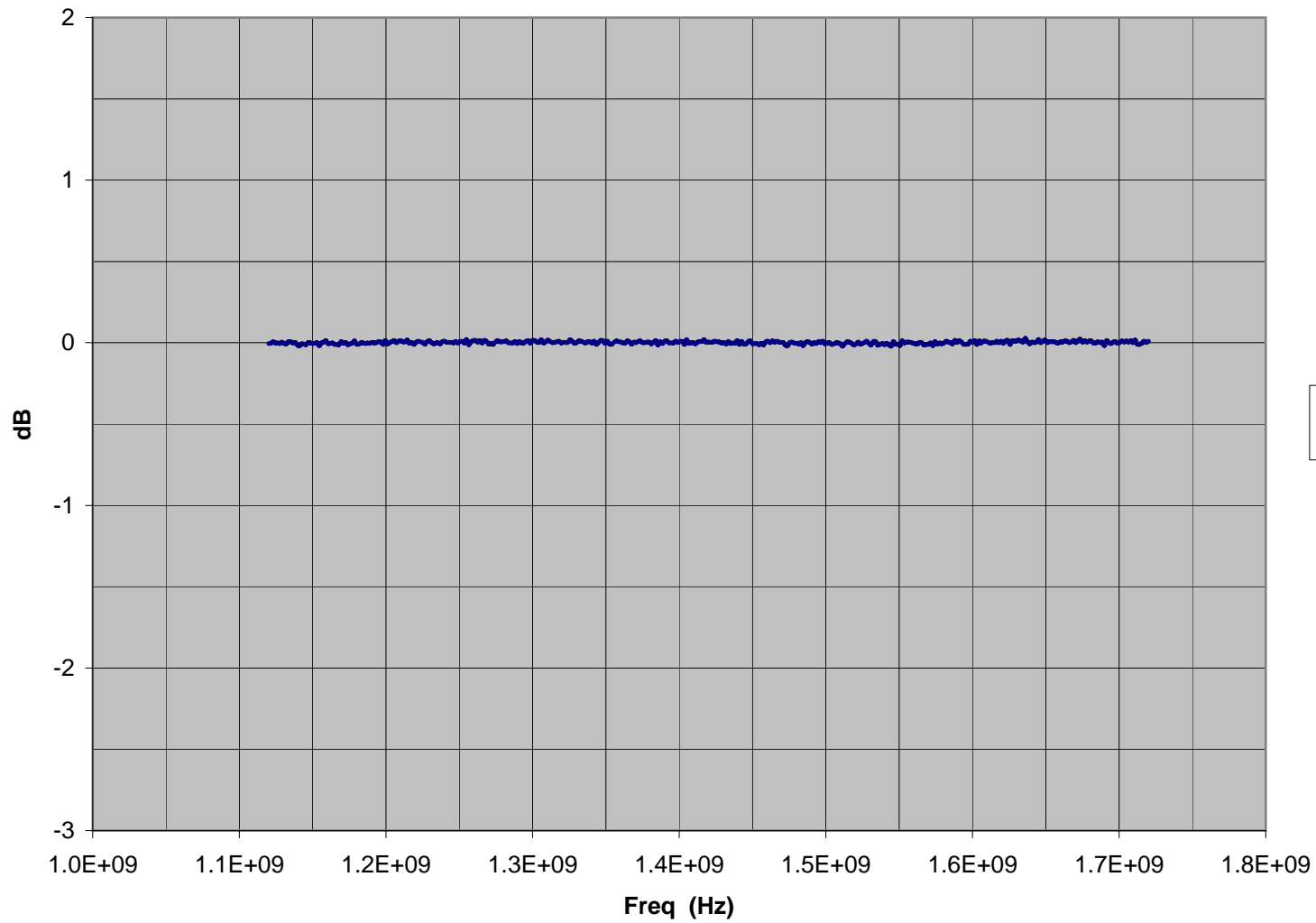

Transmission from B & A Noise sources, to A & B CAL outputs respectively
HXCAL

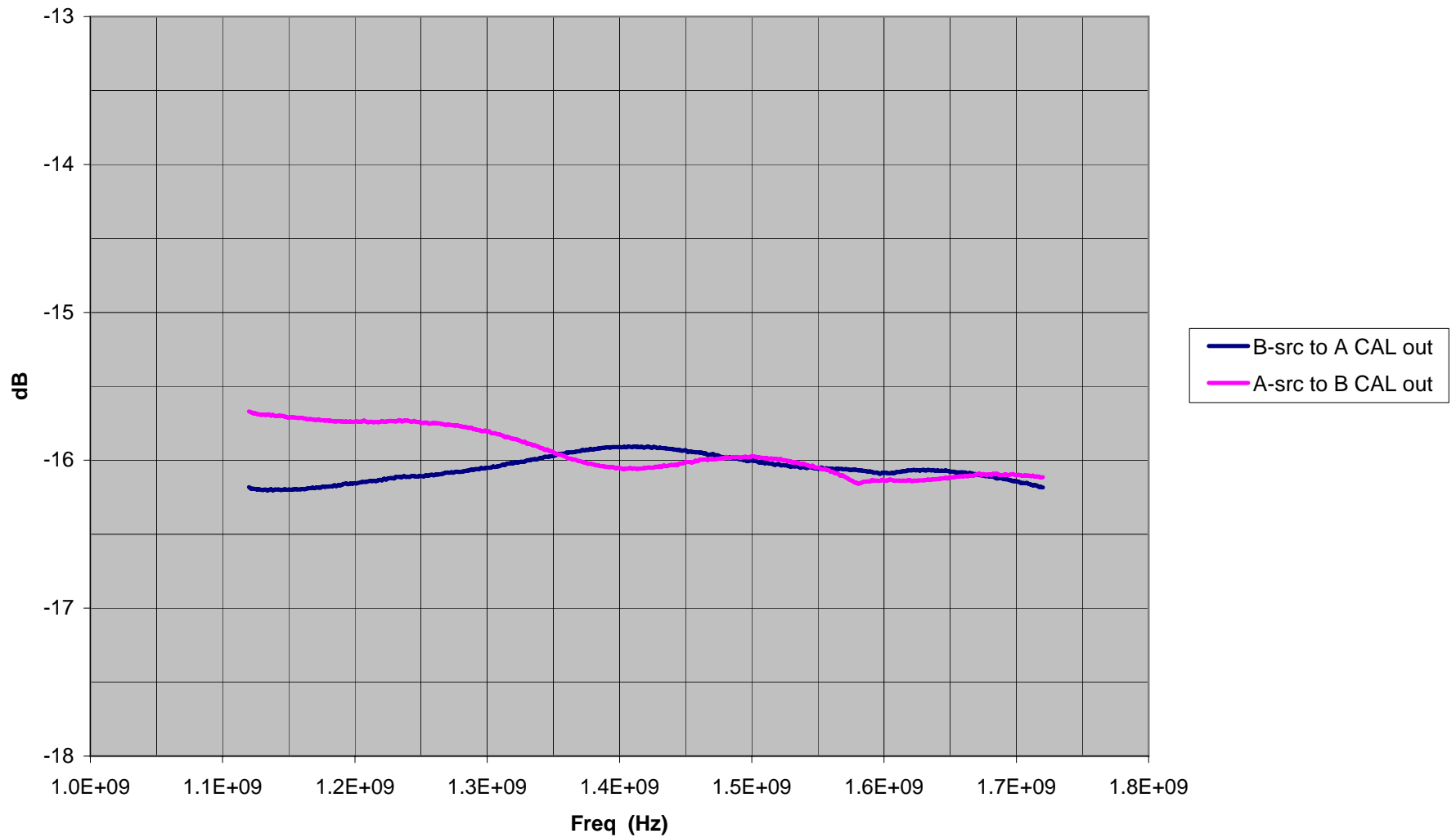

Transmission from B & A Noise sources, to A & B CAL outputs respectively
LXCAL

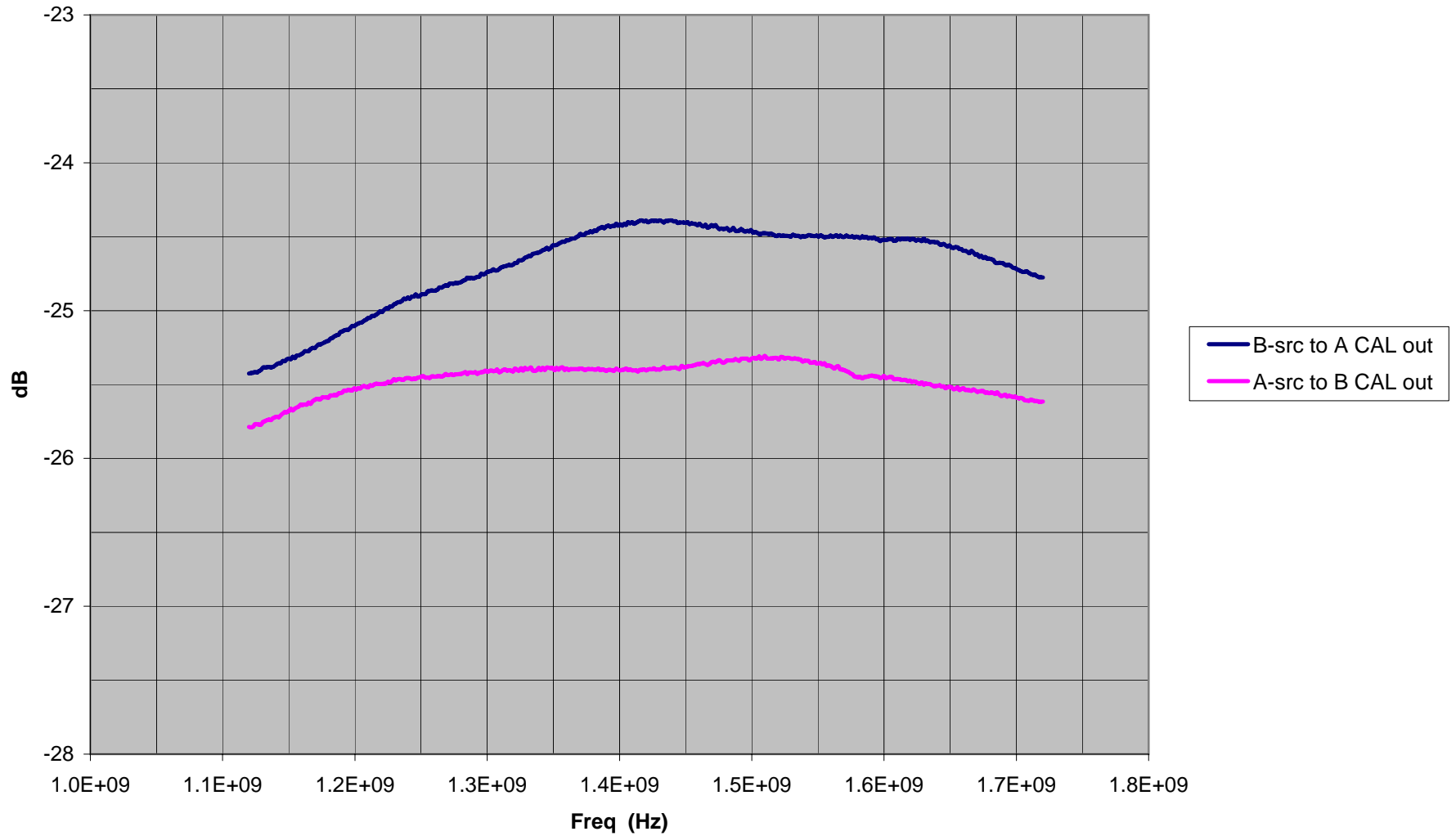

Transmission from A & B Noise sources, to A & B CAL outputs respectively
HCAL

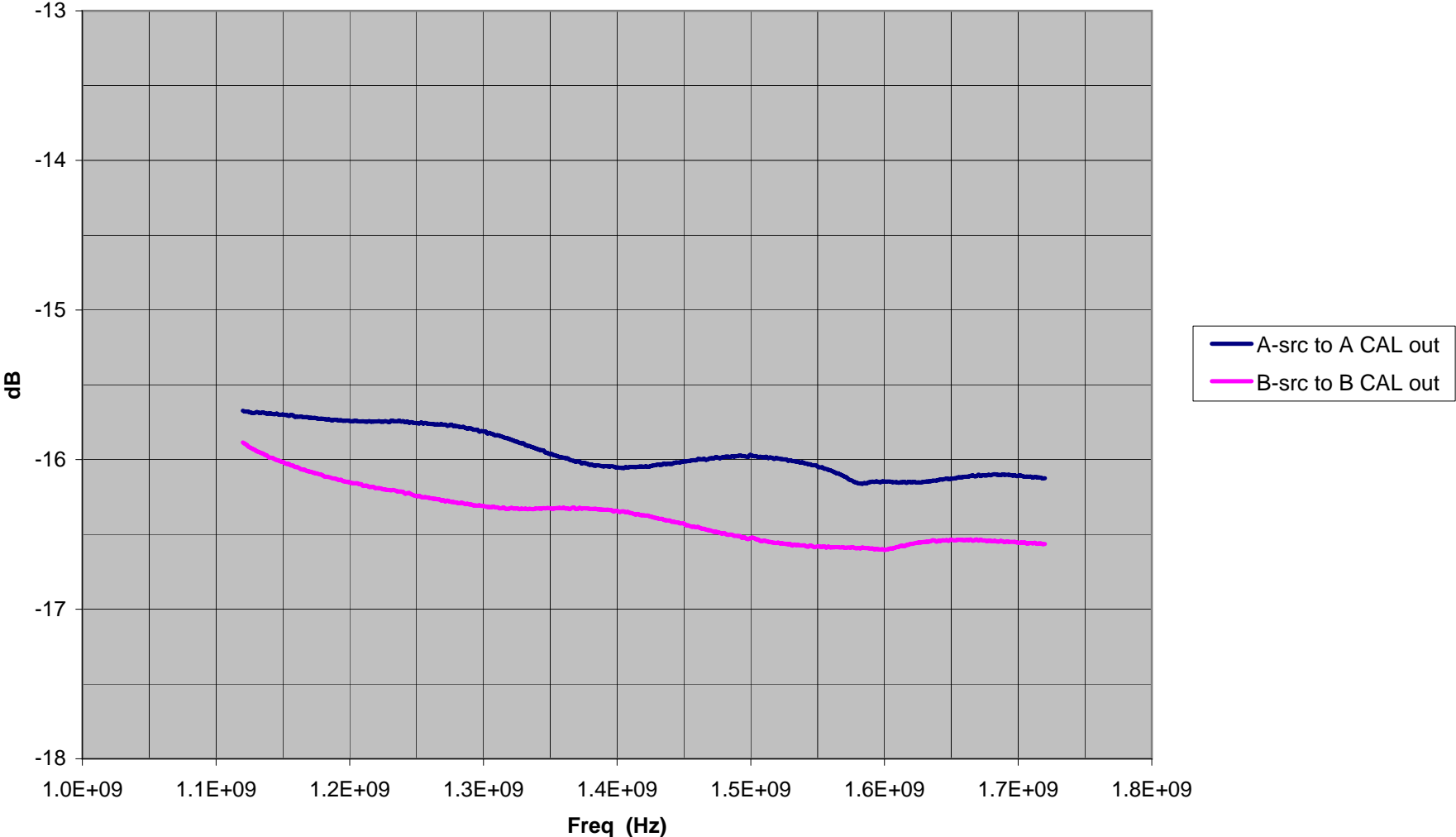

Transmission from A & B Noise sources, to A & B CAL outputs respectively
HCAL

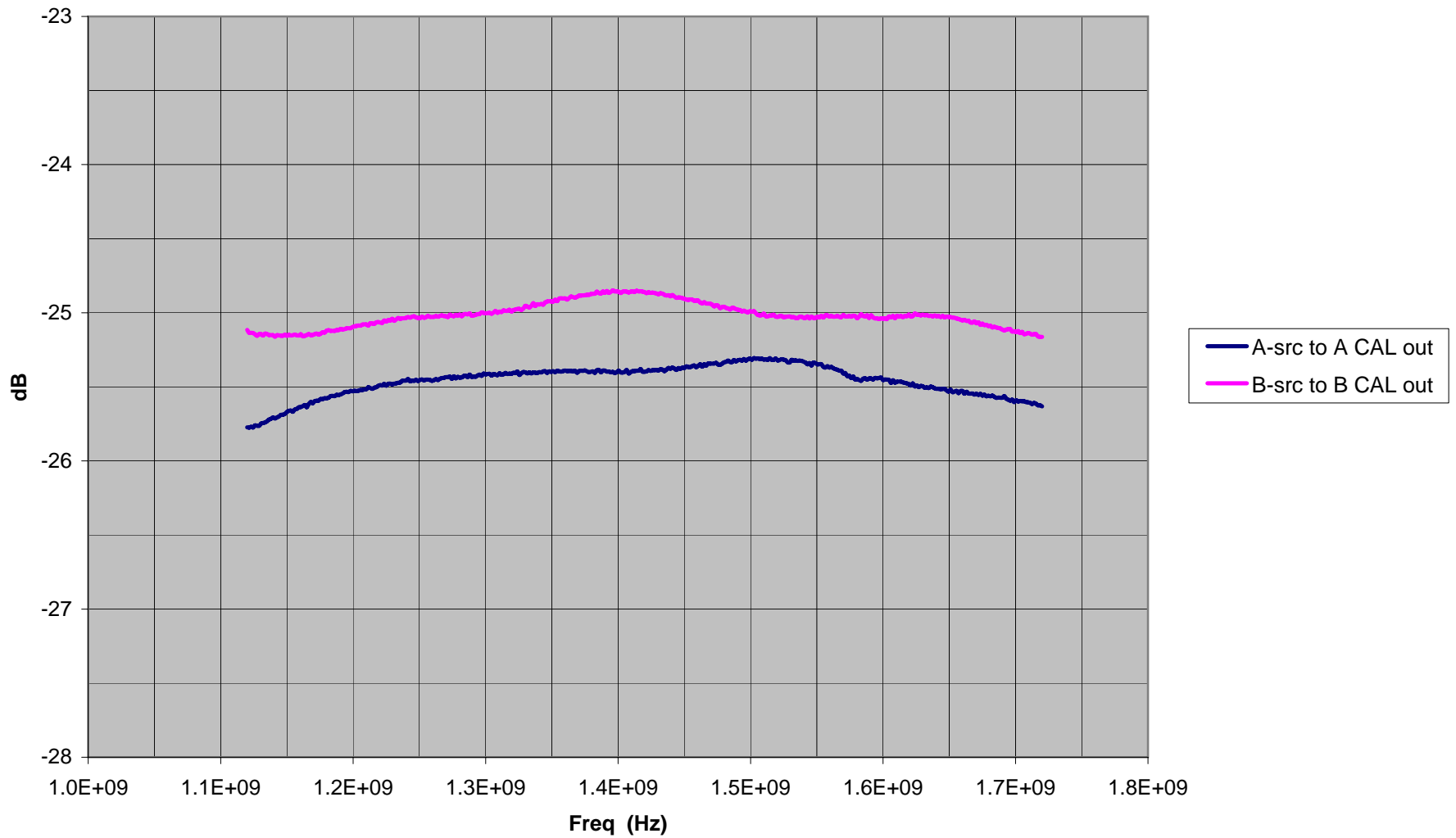

Transmission from Noise source B, to A & B CAL outputs
H90CAL

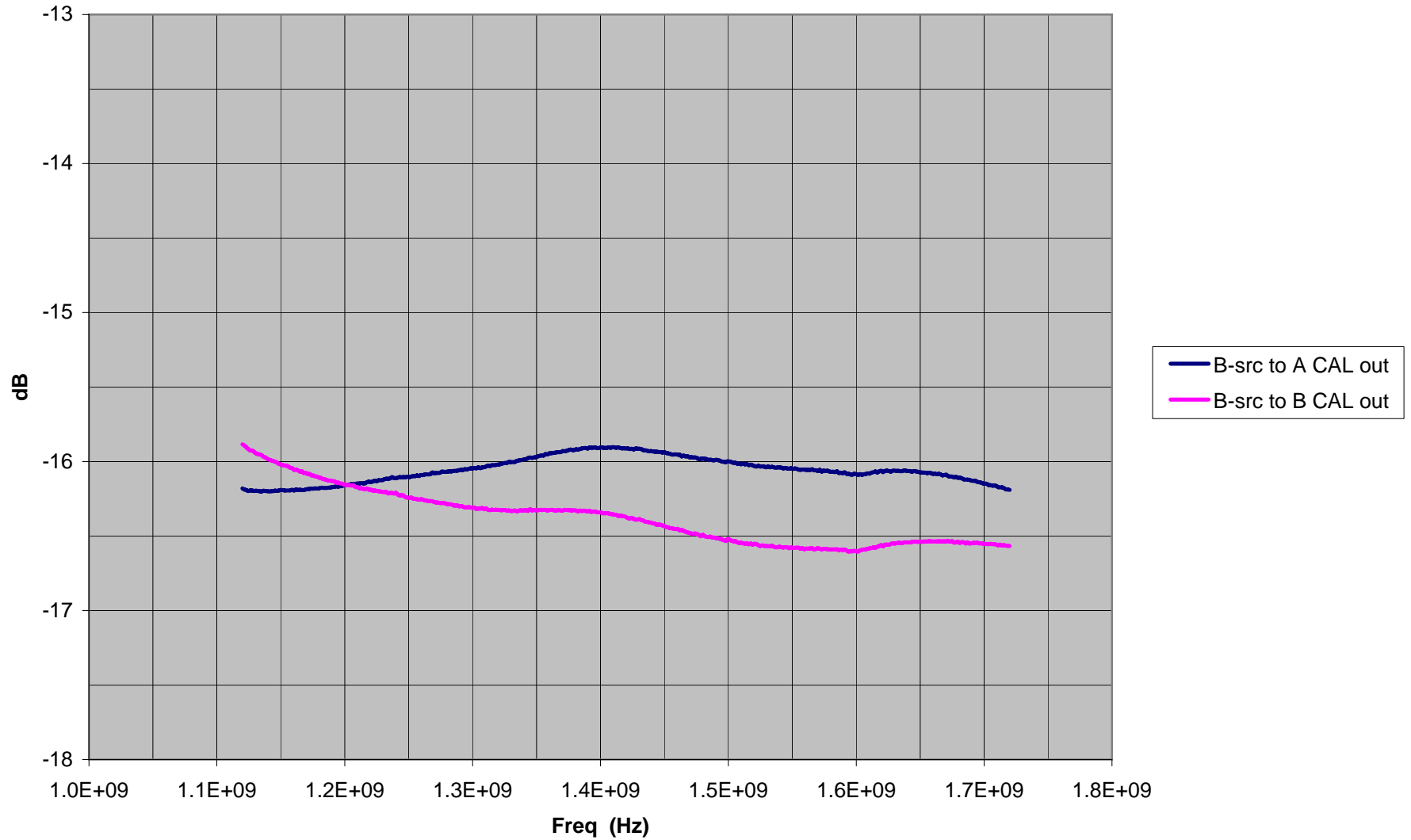

Transmission from Noise source B, to A & B CAL outputs
L90CAL

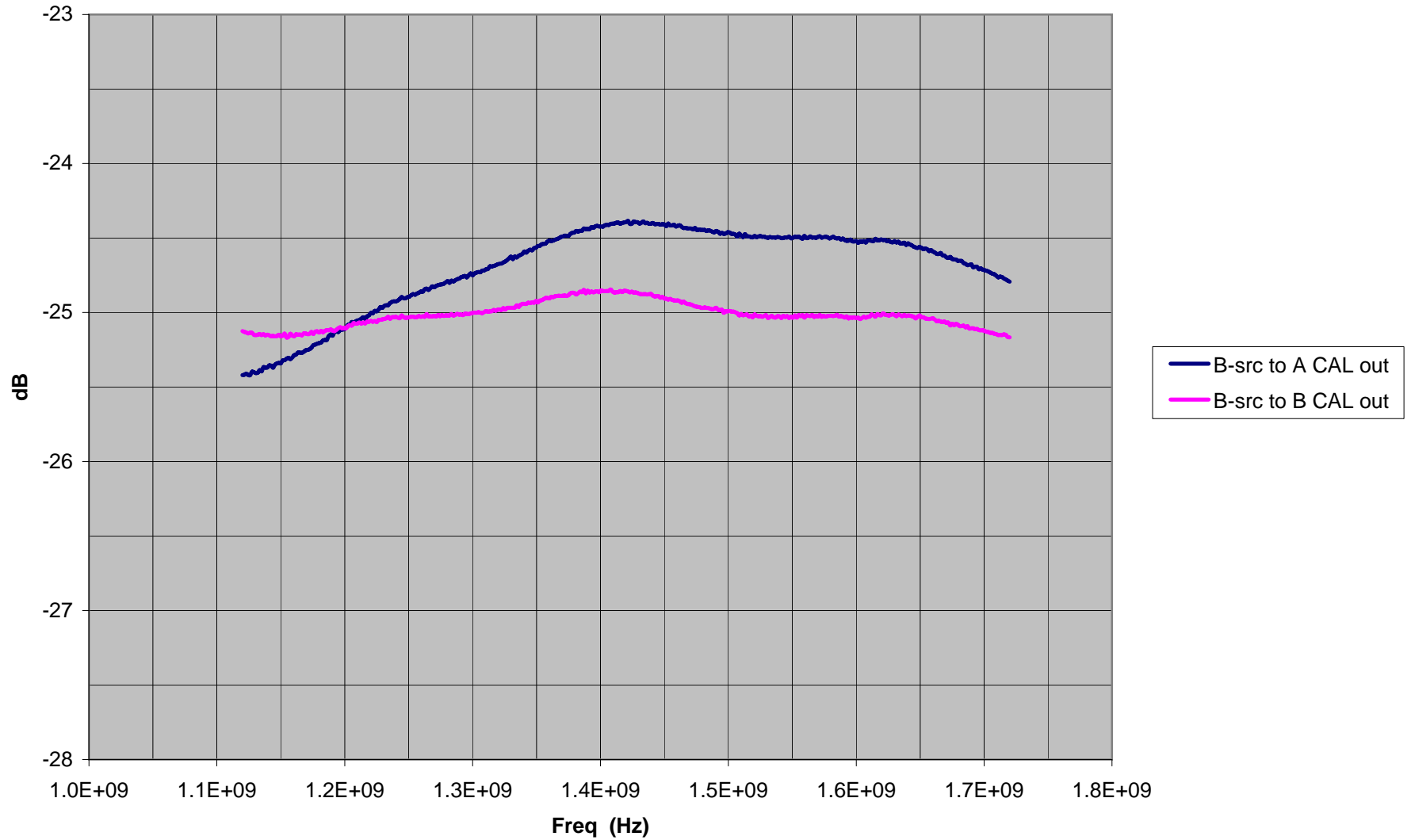

Angl(Bout/Aout): driven by source B
H90CAL

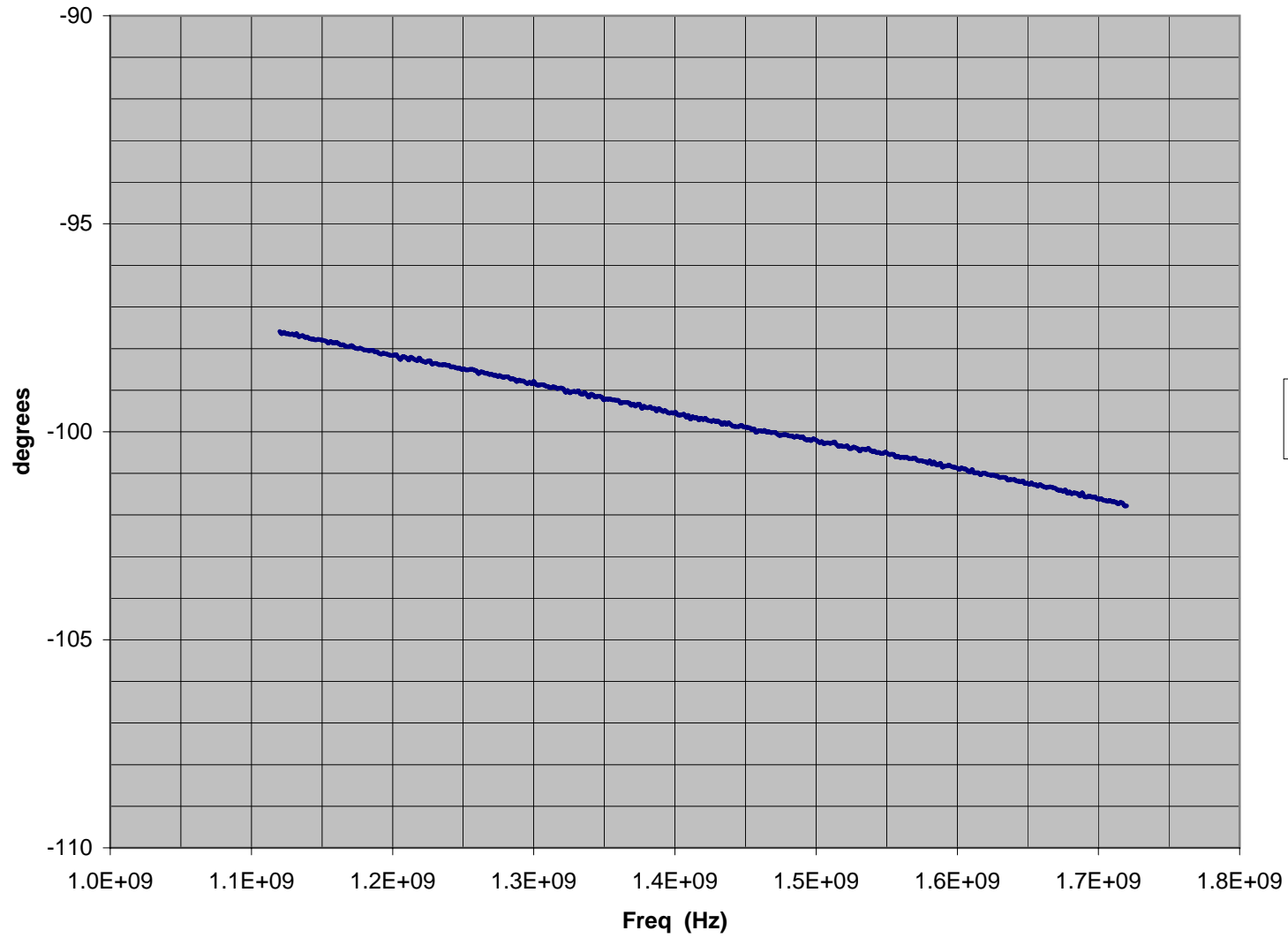

Angl(Bout/Aout): driven by source B
L90CAL

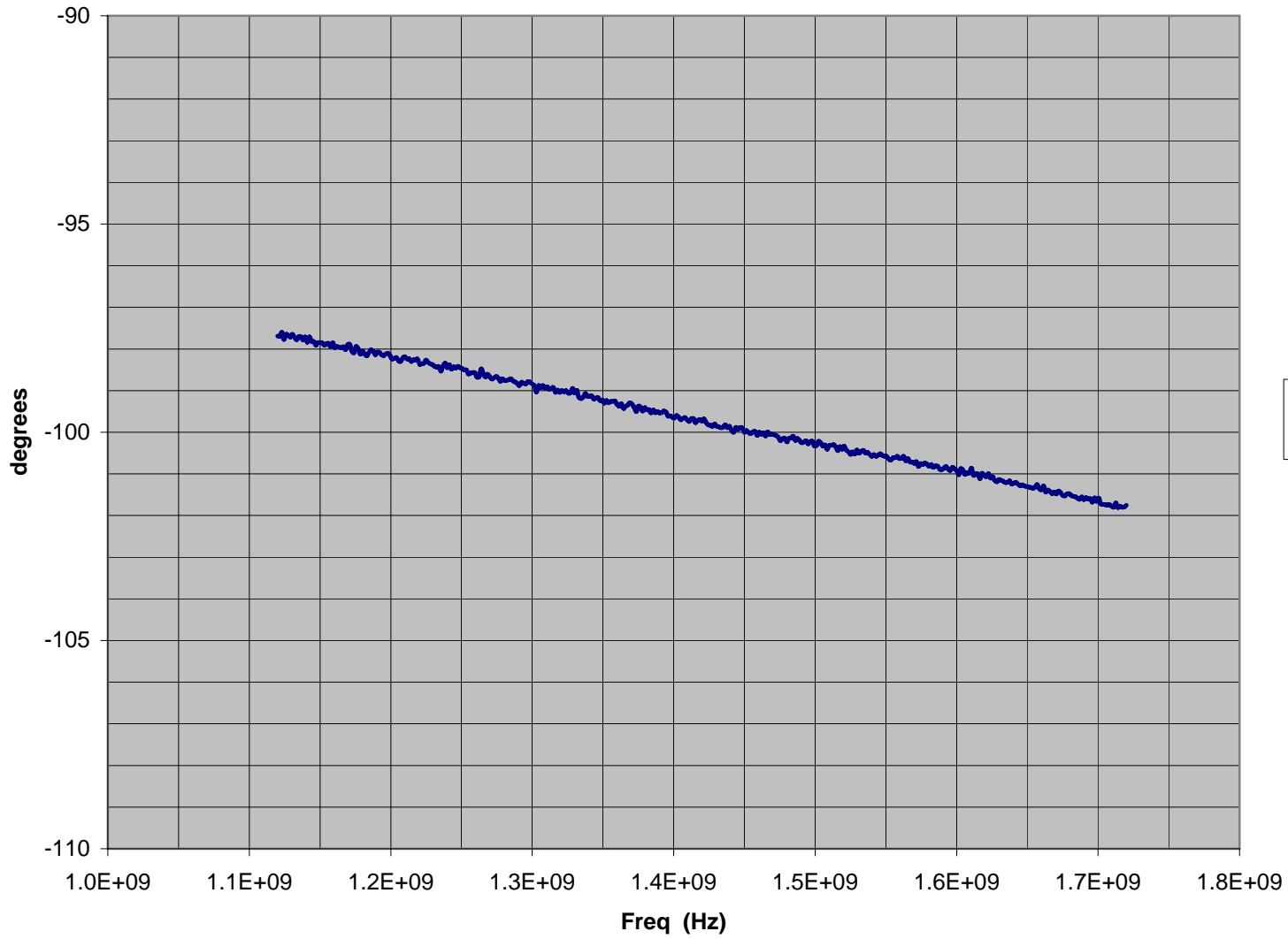

— angl(Bout/Aout)

Magn(Bout/Aout): driven by source B
H90CAL

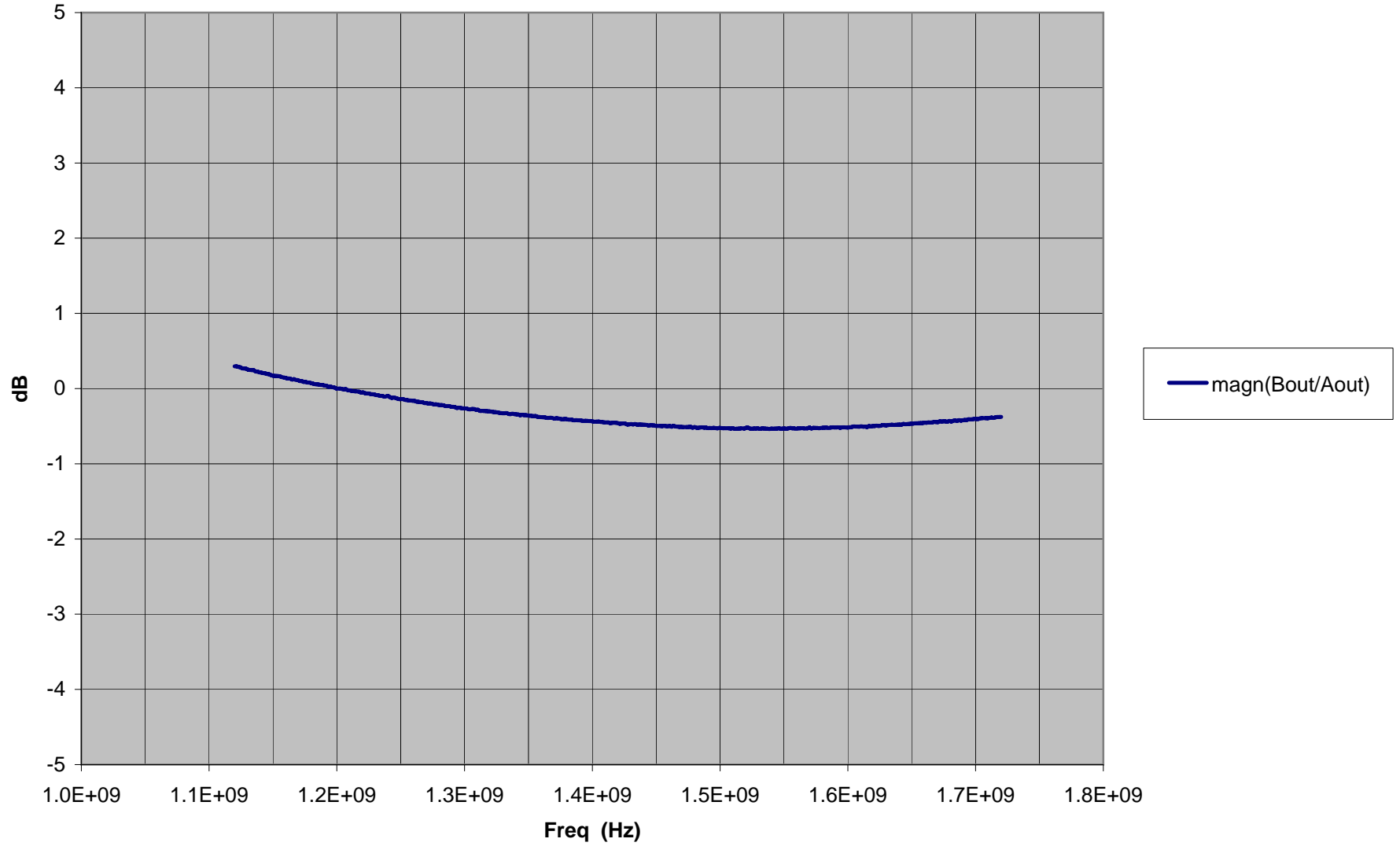

Magn(Bout/Aout): driven by source B
L90CAL

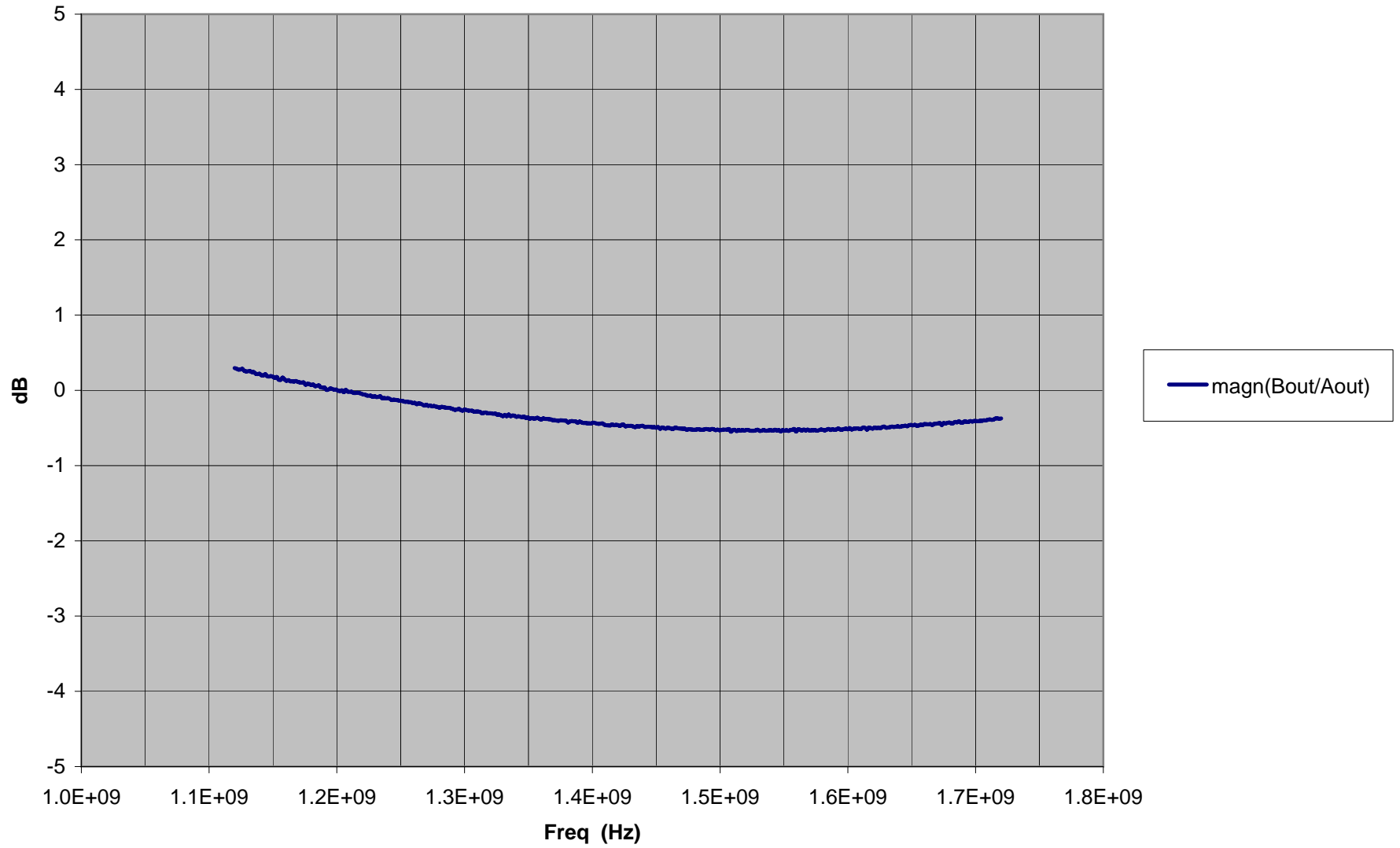

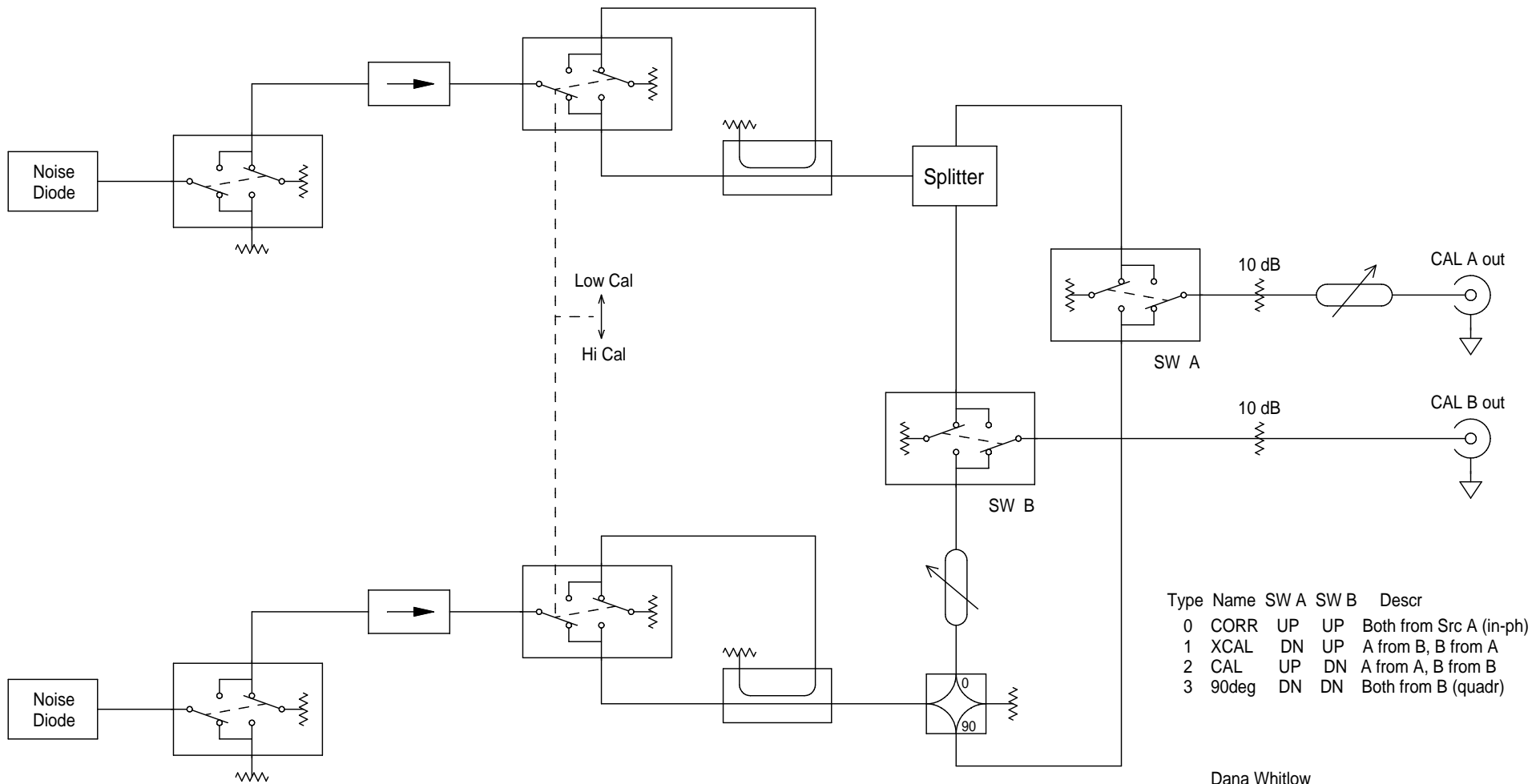

LBW CAL Switch Block Diagram

Dana Whitlow
 8 April 2008
 LBW_CAL_blk.fc7