

Spectrum Analysis Back to Basics



Agilent Technologies

Agenda

Introduction

Overview:

- What is Spectrum and Signal Analysis?
- What Measurements are available?

Theory of Operation

Specifications

Modern Signal Analyzer Designs & Capabilities

- Wide Bandwidth Vector Measurements

Wrap-up

Appendix

2

 Agilent Technologies

Back to Basics Training

This presentation is intended to be a beginning tutorial on signal analysis. Vector signal analysis includes but is not restricted to spectrum analysis. It is written for those who are unfamiliar with spectrum analyzers and vector signal analyzers, and would like a basic understanding of how they work, what you need to know to use them to their fullest potential, and how to make them more effective for particular applications. It is written for new engineers and technicians, therefore a basic understanding of electrical concepts is recommended.

We will begin with an overview of spectrum analysis. In this section, we will define spectrum analysis as well as present a brief introduction to the types of tests that are made with a spectrum and signal analyzer. From there, we will learn about spectrum and signal analyzers in terms of the hardware inside, what the importance of each component is, and how it all works together. In order to make measurements on a signal analyzer and to interpret the results correctly, it is important to understand the characteristics of the analyzer. Spectrum and signal analyzer specifications will help you determine if a particular instrument will make the measurements you need to make, and how accurate the results will be.

New digital modulation types have introduced the necessity of new types of tests made on the signals. In addition to traditional spectrum analyzer tests, new power tests and demodulation measurements have to be performed. We will introduce these types of tests and what type of instruments that are needed to make them.

And finally, we will wrap up with a summary.

For the remainder of the speaker notes, spectrum and signal analysis will simply be referred to as spectrum analysis. Sections that refer to vector signal analysis, in particular, will specify it as vector signal analysis.

Let's begin with an Overview of Spectrum Analysis.

Analyzer Definitions

Spectrum Analyzer

- “A spectrum analyzer measures the magnitude of an input signal versus frequency within the full frequency range of the instrument. The primary use is to measure the power of the spectrum of known and unknown signals.”

Vector Signal Analyzer

- “A vector signal analyzer measures the magnitude and phase of an input signal at a single frequency within the IF bandwidth of the instrument. The primary use is to make in-channel measurements, such as error vector magnitude, code domain power, and spectral flatness, on known signals.”

Signal Analyzer

- “A signal analyzer provides the functions of a spectrum analyzer and a vector signal analyzer.”

Overview

What is Spectrum Analysis?

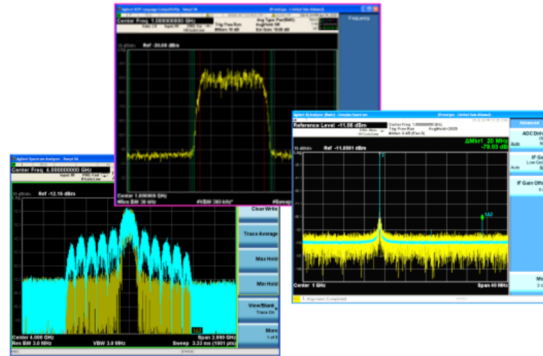

Spectrum Analysis

- Display and measure amplitude versus frequency for RF & MW signals
- Separate or demodulate complex signals into their base components (sine waves)

4



Agilent Technologies

[Back to Basics Training](#)

If you are designing, manufacturing, or doing field service/repair of electrical devices or systems, you need a tool that will help you analyze the electrical signals that are passing through or being transmitted by your system or device. By analyzing the characteristics of the signal once its gone through the device/system, you can determine the performance, find problems, troubleshoot, etc.

How do we measure these electrical signals in order to see what happens to them as they pass through our device/system and therefore verify the performance? We need a passive receiver, meaning it doesn't do anything to the signal - it just displays it in a way that makes analysis of the signal easy. This is called a spectrum analyzer. Spectrum analyzers usually display raw, unprocessed signal information such as voltage, power, period, wave shape, sidebands, and frequency. They can provide you with a clear and precise window into the frequency spectrum. A vector signal analyzer can display the data in the same way as a spectrum analyzer, but it has the added ability to display and process the time data of the signal.

Depending upon the application, a signal could have several different characteristics. For example, in communications, in order to send information such as your voice or data, it must be modulated onto a higher frequency carrier. A modulated signal will have specific characteristics depending on the type of modulation used. When testing non-linear devices such as amplifiers or mixers, it is important to understand how these create distortion products and what these distortion products look like. Understanding the characteristics of noise and how a noise signal looks compared to other types of signals can also help you in analyzing your device/system.

Understanding the important aspects of a spectrum analyzer for measuring all of these types of signals will help you make more accurate measurements and give you confidence that you are interpreting the results correctly.

Agilent Technologies' Signal Analysis Portfolio

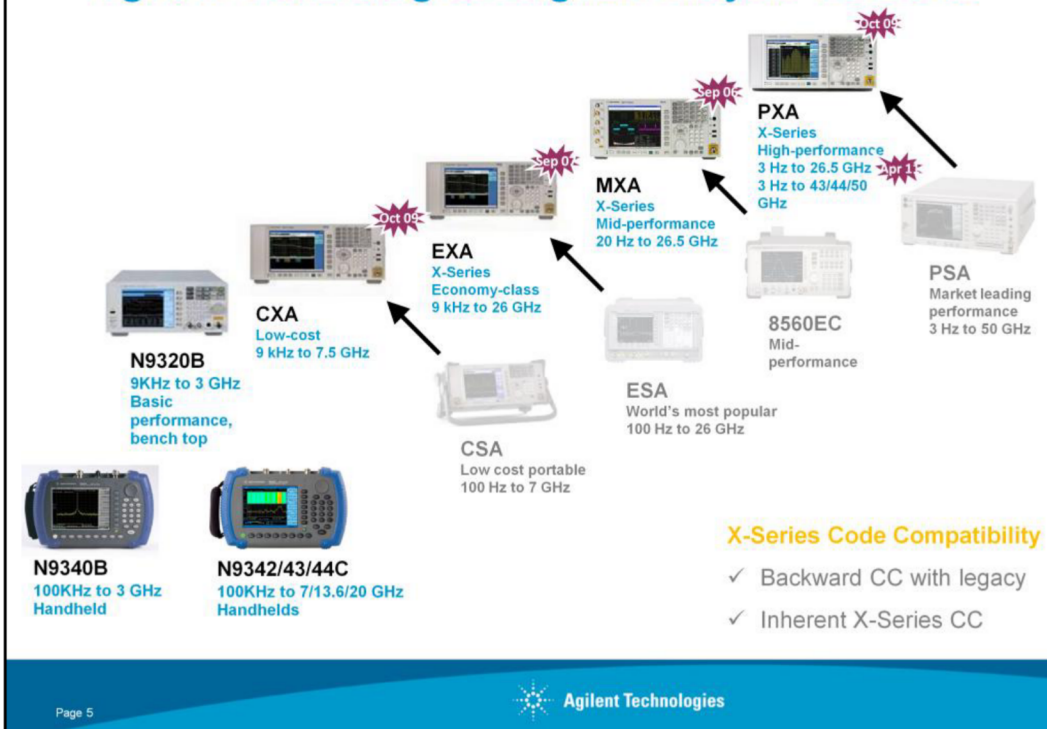

A year and a half after the first introduction of the PXA, Agilent is now introducing the world's highest performance mmW signal analyzer in April '11.

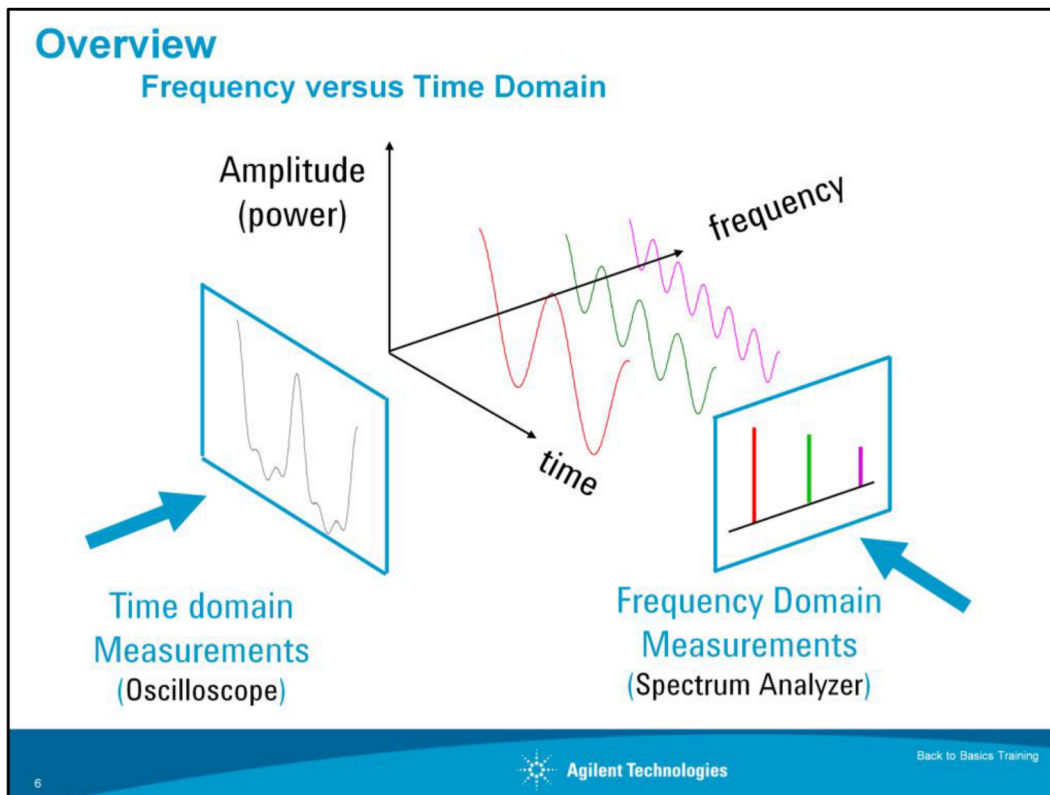

Traditionally, when you want to look at an electrical signal, you use an oscilloscope to see how the signal varies with time. This is very important information, however, it doesn't give you the full picture. To fully understand the performance of your device/system, you will also want to analyze the signal(s) in the frequency-domain. This is a graphical representation of the signal's amplitude as a function of frequency. The spectrum analyzer is to the frequency domain as the oscilloscope is to the time domain. (It is important to note that spectrum analyzers can also be used in the fixed-tune mode (zero span) to provide time-domain measurement capability much like that of an oscilloscope.)

The figure shows a signal in both the time and the frequency domains. In the time domain, all frequency components of the signal are summed together and displayed. In the frequency domain, complex signals (that is, signals composed of more than one frequency) are separated into their frequency components, and the level at each frequency is displayed.

Frequency domain measurements have several distinct advantages. For example, let's say you're looking at a signal on an oscilloscope that appears to be a pure sine wave. A pure sine wave has no harmonic distortion. If you look at the signal on a spectrum analyzer, you may find that your signal is actually made up of several frequencies. What was not discernible on the oscilloscope becomes very apparent on the spectrum analyzer.

Some systems are inherently frequency domain oriented. For example, many telecommunications systems use what is called Frequency Division Multiple Access (FDMA) or Frequency Division Multiplexing (FDM). In these systems, different users are assigned different frequencies for transmitting and receiving, such as with a cellular phone. Radio stations also use FDM, with each station in a given geographical area occupying a particular frequency band. These types of systems must be analyzed in the frequency domain in order to make sure that no one is interfering with users/radio stations on neighboring frequencies. We shall also see later how measuring with a frequency domain analyzer can greatly reduce the amount of noise present in the measurement because of its ability to narrow the measurement bandwidth.

From this view of the spectrum, measurements of frequency, power, harmonic content, modulation, spurs, and noise can easily be made. Given the capability to measure these quantities, we can determine total harmonic distortion, occupied bandwidth, signal stability, output power, intermodulation distortion, power bandwidth, carrier-to-noise ratio, and a host of other measurements, using just a spectrum analyzer.

Overview

Types of Measurements Available

Frequency, power, modulation, distortion & noise

- Spectrum monitoring
 - Spurious emissions
 - Scalar network analysis
 - Noise figure & phase noise
 - Harmonic & intermodulation distortion
 - Analog, digital, burst & pulsed RF Modulation
 - Wide bandwidth vector analysis
 - Electromagnetic interference
-
- *Measurement range (-172 dBm to +30 dBm)*
 - *Frequency range (3 Hz to >>325 GHz)*



Modulation

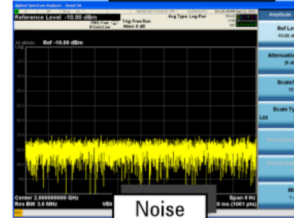

Noise



Distortion



Spur Search

Overview

Different Types of Analyzers

FFT Analyzer

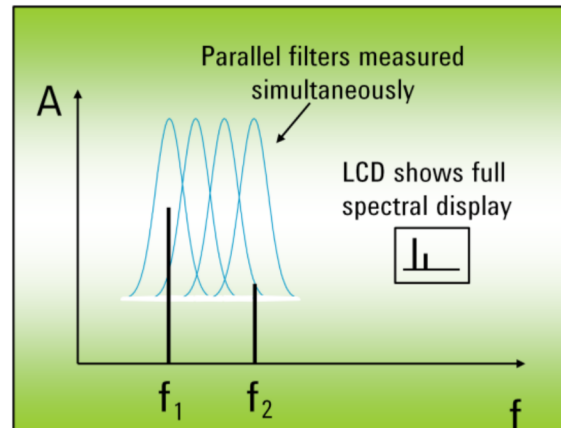

8

Agilent Technologies

Back to Basics Training

Now that we understand why spectrum analyzers are important, let's take a look at the different types of analyzers available for measuring RF.

There are basically two ways to make frequency domain measurements (what we call spectrum analysis): Fast Fourier transform (FFT) and swept-tuned.

The FFT analyzer basically takes a time-domain signal, digitizes it using digital sampling, and then performs the mathematics required to convert it to the frequency domain*, and display the resulting spectrum. It is as if the analyzer is looking at the entire frequency range at the same time using parallel filters measuring simultaneously. It is actually capturing the time domain information which contains all the frequency information in it. With its real-time signal analysis capability, the Fourier analyzer is able to capture periodic as well as random and transient events. It also can measure phase as well as magnitude, and under some measurement conditions (spans that are within the bandwidth of the digitizer or when wide spans and narrow RBW settings are used in a modern SA with digital IF processing), FFT can be faster than swept. Under other conditions (spans that are much wider than the bandwidth of the digitizer with wider RBW settings), swept is faster than FFT.

Fourier analyzers are becoming more prevalent, as analog-to-digital converters (ADC) and digital signal processing (DSP) technologies advance. Operations that once required a lot of custom, power-hungry discrete hardware can now be performed with commercial off-the-shelf DSP chips, which get smaller and faster every year.

* The frequency domain is related to the time domain by a body of knowledge generally known as Fourier theory (named for Jean Baptiste Joseph Fourier, 1768-1830). Discrete, or digitized signals can be transformed into the frequency domain using the *discrete Fourier transform*.

Overview

Different Types of Analyzers

Swept Analyzer

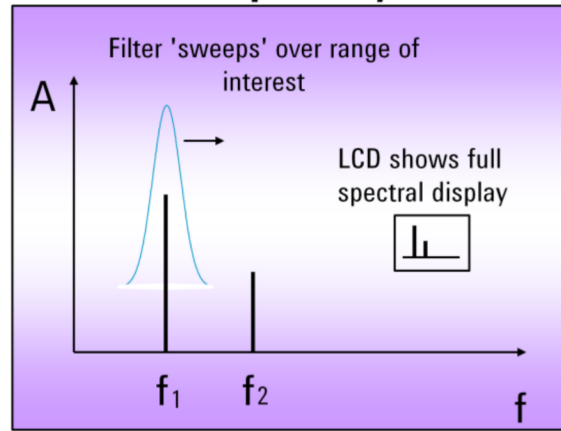

The other type of spectrum analyzer is the swept-tuned receiver. It has traditionally been the most widely accepted, general-purpose tool for frequency-domain measurements. The technique most widely used is super-heterodyne. Heterodyne means to mix - that is, to translate frequency - and super refers to super-audio frequencies, or frequencies above the audio range. Very basically, these analyzers "sweep" across the frequency range of interest, displaying all the frequency components present. We shall see how this is actually accomplished in the next section. The swept-tuned analyzer works just like the AM radio in your home except that on your radio, the dial controls the tuning and instead of a display, your radio has a speaker.

The swept receiver technique enables frequency domain measurements to be made over a large dynamic range and a wide frequency range, thereby making significant contributions to frequency-domain signal analysis for numerous applications, including the manufacture and maintenance of microwave communications links, radar, telecommunications equipment, cable TV systems, broadcast equipment, mobile communication systems, EMI diagnostic testing, component testing, and signal surveillance.

Agenda

Introduction

Overview

Theory of Operation:

- Swept Spectrum Analyzer Hardware

Specifications

Modern spectrum analyzer designs & capabilities

- Wide Bandwidth Vector Measurements

Wrap-up

Appendix

Based on the previous slide, you might be picturing the inside of the analyzer consisting of a bandpass filter that sweeps across the frequency range of interest. If the input signal is say, 1 MHz, then when the bandpass filter passes over 1 MHz, it will "see" the input signal and display it on the screen.

Although this concept would work, it is very difficult and therefore expensive to build a filter which tunes over a wide range. An easier, and therefore less expensive, implementation is to use a tunable local oscillator (LO), and keep the bandpass filter fixed. We will see when we go into more detail, that in this concept, we are sweeping the input signal past the fixed filter, and as it passes through the fixed bandpass filter, it is displayed on the screen. Don't worry if it seems confusing now - as we discuss the block diagram, the concept will become clearer.

We will first go into more detail as to how the swept spectrum analyzer works. Then we will compare that architecture to the architecture of a modern FFT analyzer.

Theory of Operation

Display terminology

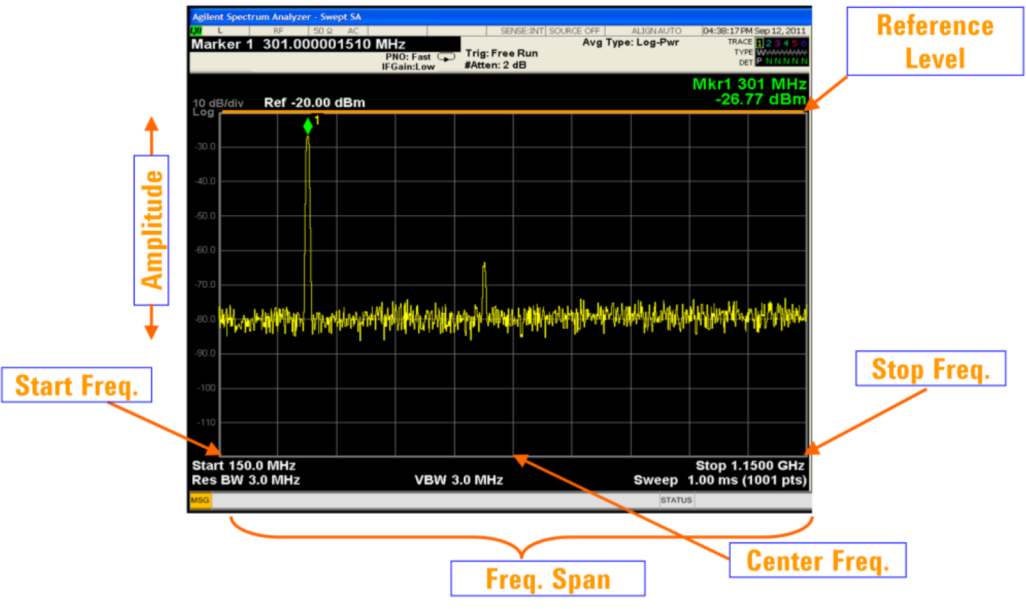

Theory of Operation

Swept Spectrum Analyzer Block Diagram

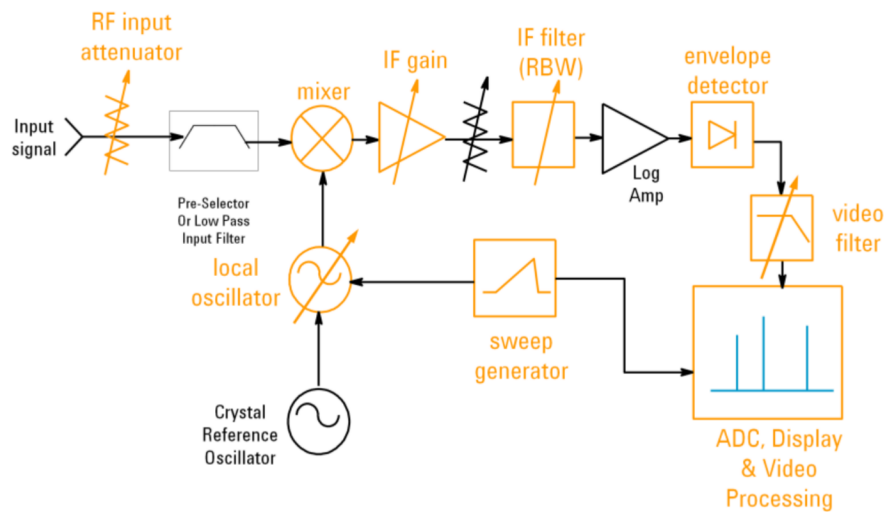

12

Agilent Technologies

Back to Basics Training

The major components in a spectrum analyzer are the RF input attenuator, mixer, IF (Intermediate Frequency) gain, IF filter, detector, video filter, local oscillator, sweep generator, and LCD display. Before we talk about how these pieces work together, let's get a fundamental understanding of each component individually.

Theory of Operation

Mixer

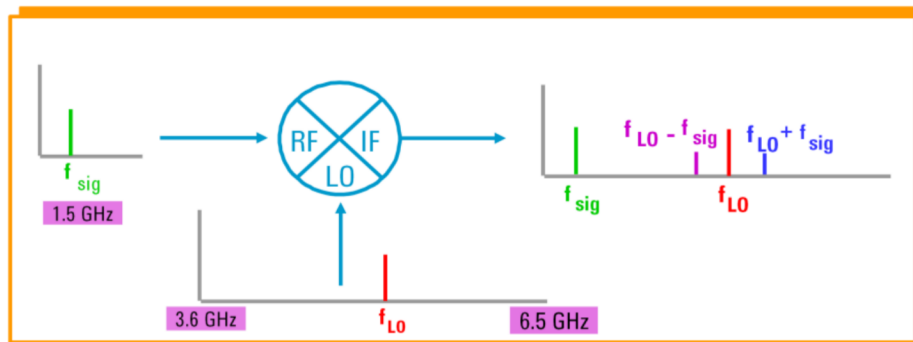
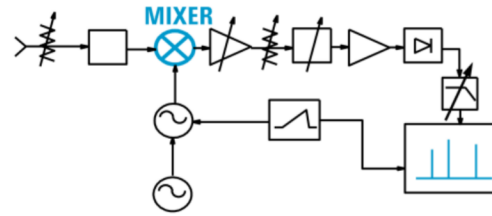

13

Agilent Technologies

Back to Basics Training

We'll start with the mixer.

A mixer is a three-port device that converts a signal from one frequency to another (sometimes called a frequency translation device). We apply the input signal to one input port, and the Local Oscillator output signal to the other. By definition, a mixer is a non-linear device, meaning that there will be frequencies at the output that were not present at the input. The output frequencies that will be produced by the mixer are the original input signals, plus the sum and difference frequencies of these two signals. It is the difference frequency that is of interest in the spectrum analyzer, which we will see shortly. We call this signal the IF signal, or Intermediate Frequency signal.

Theory of Operation

IF Filter (Resolution Bandwidth – RBW)

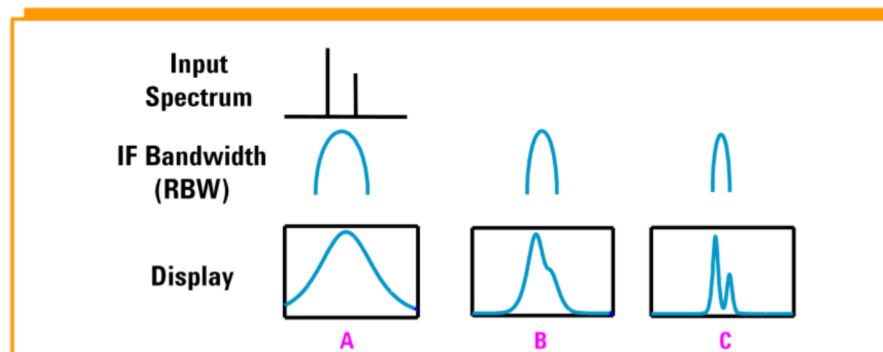
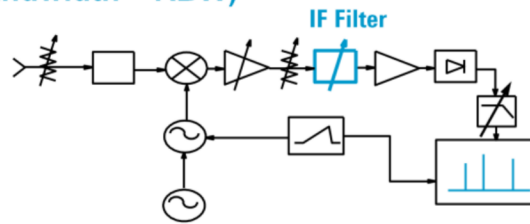

The IF filter is a bandpass filter which is used as the "window" for detecting signals. Its bandwidth is also called the resolution bandwidth (RBW) of the analyzer and can be changed via the front panel of the analyzer.

By giving you a broad range of variable resolution bandwidth settings, the instrument can be optimized for the sweep and signal conditions, letting you trade-off frequency selectivity (the ability to resolve signals), signal-to-noise ratio (SNR), and measurement speed.

We can see from the slide that as RBW is narrowed, selectivity is improved (we are able to resolve the two input signals). This will also often improve SNR. The sweep speed and trace update rate, however, will degrade with narrower RBWs. The optimum RBW setting depends heavily on the characteristics of the signals of interest.

Theory of Operation

Envelope Detector

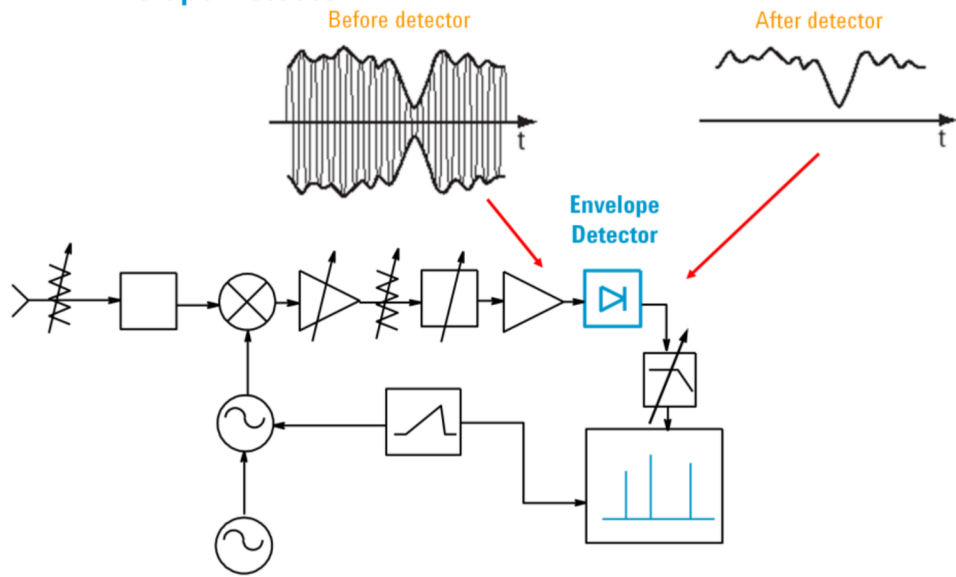

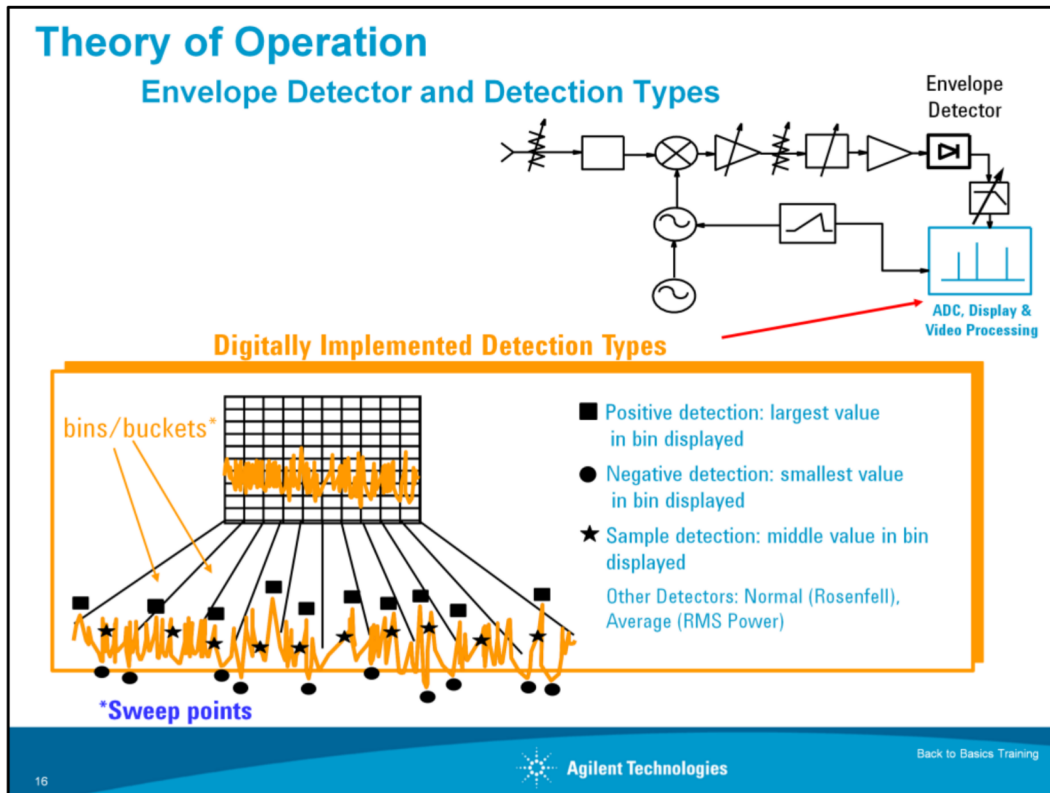

The analyzer must convert the IF signal to a baseband or video signal so it can be digitized and then viewed on the analyzer display. This is accomplished with an envelope detector whose video output is then digitized with an analog-to-digital converter (ADC). The digitized output of the ADC is then represented as the signal's amplitude on the Y-axis of the display. This allows for several different detector modes that dramatically affect how the signal is displayed.

In positive detection mode, we take the peak value of the signal over the duration of one trace element, whereas in negative detection mode, it's the minimum value. Positive detection mode is typically used when analyzing sinusoids, but is not good for displaying noise, since it will not show the true randomness of the noise. In sample detection, a random value for each bin is produced. For burst or narrowband signals, it is not a good mode to use, as the analyzer might miss the signals of interest.

When displaying both signals and noise, the best mode is the normal mode, or the rosenfell mode. This is a "smart" mode, which will dynamically change depending upon the input signal. For example, if the signal both rose and fell within a sampling bin, it assumes it is noise and will use positive & negative detection alternately. If it continues to rise, it assumes a signal and uses positive peak detection.

Another type of detector that is not shown on the graph is an Average detector. This is also called an rms detector and is the most useful when measuring noise or noise-like signals.

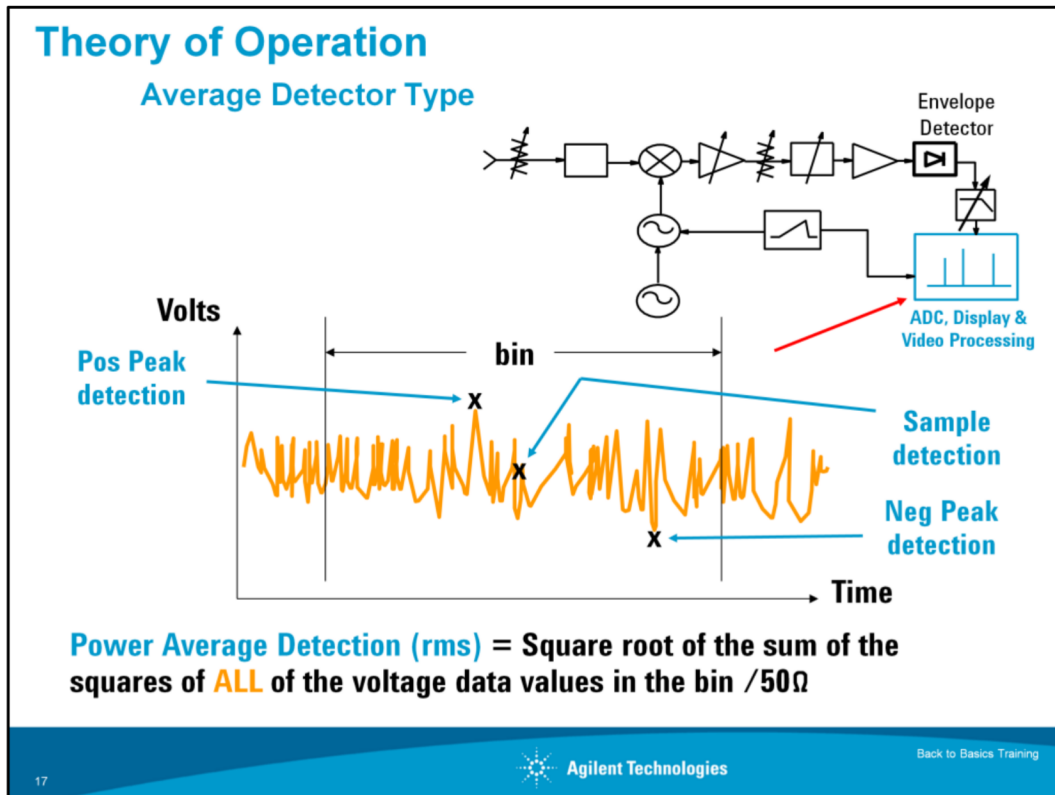

Although modern digital modulation schemes have noise-like characteristics, sample detection does not always provide us with the information we need. For instance, when taking a channel power measurement on a W-CDMA signal, integration of the rms values is required. This measurement involves summing power across a range of analyzer frequency buckets. Sample detection does not provide this.

While spectrum analyzers typically collect amplitude data many times in each bin, sample detection keeps only one of those values and throws away the rest. On the other hand, an averaging detector uses all of the data values collected within the time interval of a bin. Once we have digitized the data, and knowing the circumstances under which they were digitized, we can manipulate the data in a variety of ways to achieve the desired results.

Some spectrum analyzers refer to the averaging detector as an rms detector when it averages the power (based on the root mean square of voltage). Agilent's spectrum analyzers can perform this and other averaging functions with the average detector. The Power (rms) averaging function calculates the **true average power**, and is best for measuring the power of complex signals.

Theory of Operation

Video Filter (Video Bandwidth – VBW)

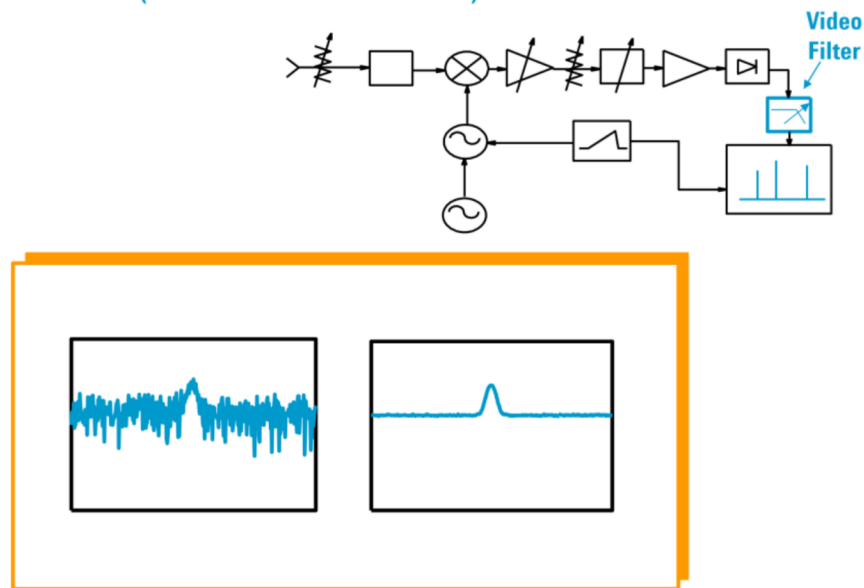

18

Agilent Technologies

Back to Basics Training

The video filter is a low-pass filter that is located after the envelope detector and before the ADC. This filter determines the bandwidth of the video amplifier, and is used to average or smooth the trace seen on the screen.

The spectrum analyzer displays *signal-plus-noise* so that the closer a signal is to the noise level, the more the noise impedes the measurement of the signal. By changing the video bandwidth (VBW) setting, we can decrease the peak-to-peak variations of noise. This type of display smoothing can be used to help find signals that otherwise might be obscured in the noise.

Theory of Operation

Video Filter vs. Trace/Video averaging

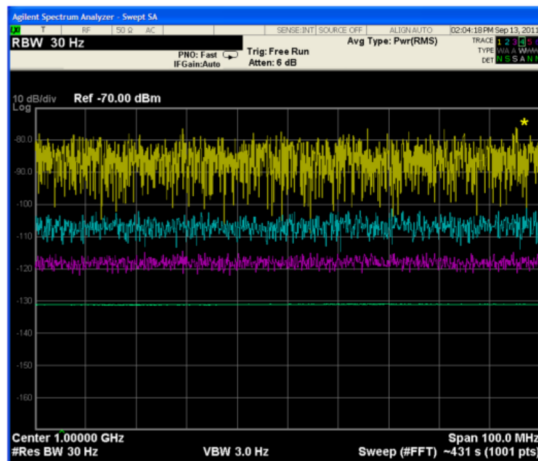

Trace averaging for 1, 5, 20, and 100 sweeps, top to bottom (trace position offset for each set of sweeps)

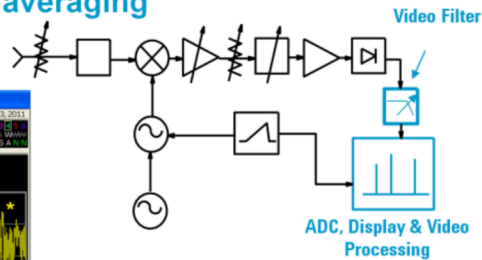

- **Video Filter** operates as the sweep progresses, sweep time may be required to slow down by the transient response of the VBW filter.

- **Trace/Video Average** takes multiple sweeps, sweep time for each sweep is not affected

- Many signals give the same results with either video filtering or trace averaging

There are several processes in a spectrum analyzer that smooth the variations in the envelope-detected amplitude. Average detection was previously discussed in the detector section of the presentation. We have just covered video filtering. There is also a process called trace averaging. There is often confusion between video averaging and trace averaging so we'll cover that here.

The video filter is a low-pass filter that comes after the envelope detector and determines the bandwidth of the video signal that is displayed. When the cutoff frequency of the video filter is reduced, the video system can no longer follow the more rapid variations of the envelope of the signal passing through the IF chain. The result is a smoothing of the displayed signal. The amount of smoothing is determined by the ratio of the video BW to resolution BW. Ratios of 0.01 or less provide very good smoothing.

Digital displays offer another choice for smoothing the display: trace averaging. This is a completely different process than that performed using the average detector. In this case, averaging is accomplished over two or more sweeps on a point-by-point basis. At each display point, the new value is averaged in with the previously averaged data. Thus, the display gradually converges to an average over a number of sweeps. Unlike video averaging, trace averaging does not affect the sweep time, however because multiple sweeps are required to average together, the time to reach a given degree of averaging is about the same as with video filtering.

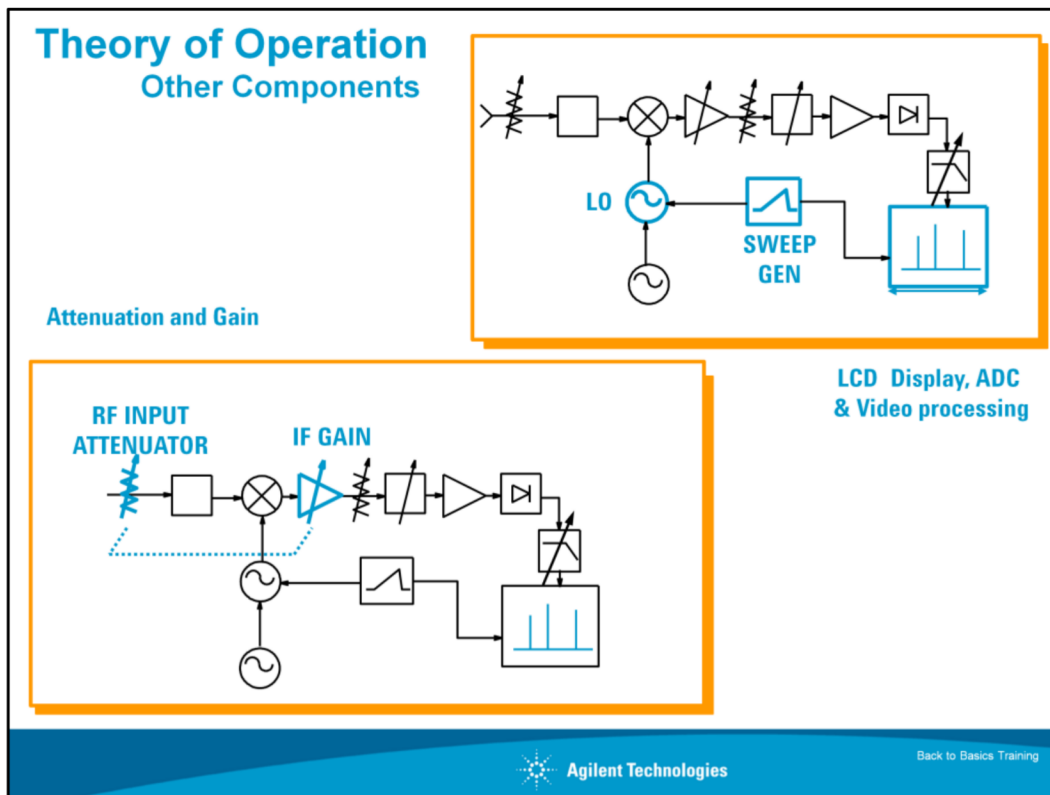

And finally, a brief description of the last few components.

The **local oscillator** (LO) is either a YIG (Yttrium Iron Garnet) tuned oscillator or Voltage Controlled Oscillator (VCO) which in effect tunes the analyzer. The sweep generator actually tunes the LO so that its frequency changes in proportion to the ramp voltage.

The sampling of the video signal by the ADC is also synchronized with the sweep generator to create the frequency scale on the x-axis. Because the relationship between the local oscillator and the input signal is known, the horizontal axis of the display can be calibrated in terms of the input signal's frequency.

The **RF input attenuator** is a step attenuator located between the input connector and the first mixer. It is also called the RF attenuator. This is used to adjust the level of the signal incident upon the first mixer. This is important in order to prevent mixer gain compression and distortion due to high-level and/or broadband signals.

The **IF gain** is located after the mixer but before the IF, or RBW, filter. This is used to adjust the vertical position of signals on the display without affecting the signal level at the input mixer. When changed, the value of the reference level is changed accordingly. Since we do not want the reference level to change (i.e. the vertical position of displayed signals) when we change the input attenuator, these two components are tied together. The IF gain will automatically be changed to compensate for input attenuator changes, so signals remain stationary on the LCD display, and the reference level is not changed.

Theory of Operation

How it All Works Together - 3 GHz spectrum analyzer

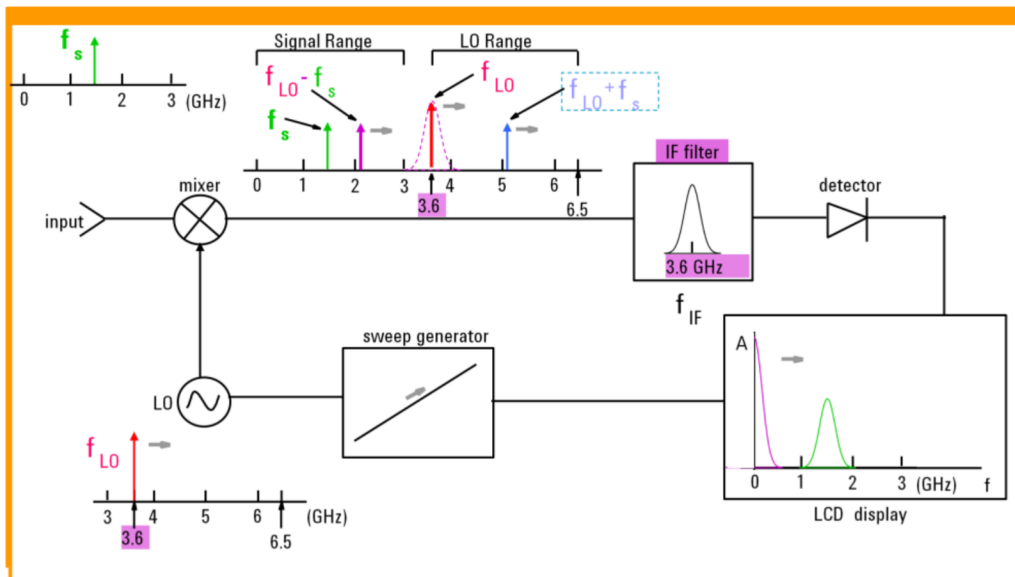

Agenda

Overview

Theory of Operation

Specifications:

- Which are important and why?

Modern spectrum analyzer designs & capabilities

- Wide Bandwidth Vector Measurements

Wrap-up

Appendix

Understanding the capabilities and limitations of a spectrum analyzer is a very important part of understanding spectrum analysis. Today's spectrum analyzers offer a great variety of features and levels of performance. Reading a datasheet can be very confusing. How do you know which specifications are important for your application and why?

Spectrum analyzer specifications are the instrument's manufacturer's way of communicating the level of performance you can expect from a particular instrument. Understanding and interpreting these specifications enables you to predict how the analyzer will perform in a specific measurement situation.

We will now describe a variety of specifications that are important to understand.

Key Specifications

- Safe spectrum analysis
- Frequency Range
- Accuracy: Frequency & Amplitude
- Resolution
- Sensitivity
- Distortion
- Dynamic Range



What do you need to know about a spectrum analyzer in order to make sure you choose one that will make the measurements you're interested in, and make them adequately? Very basically, you need to know 1) the frequency range, 2) the amplitude range (maximum input and sensitivity), 3) the difference between two signals, both in amplitude (dynamic range) and frequency (resolution), and 4) accuracy of measurements once you've made them.

Although not in the same order, we will describe each of these areas in detail in terms of what they mean and why they are important.

Specifications?

A Definition

Specifications describe the performance of parameters covered by the product warranty (temperature = 0 to 55°C, unless otherwise noted).

Typical values describe additional product performance information that is not covered by the product warranty. It is performance beyond specification that 80 % of the units exhibit with a 95 % confidence level over the temperature range 20 to 30° C. Typical performance does not include measurement uncertainty.

Nominal values indicate expected performance, or describe product performance that is useful in the application of the product, but is not covered by the product warranty.

Specifications

Practicing safe spectrum analysis - *Safe Hookups to RF Input*

- Use best practices to eliminate static discharge to the RF input!
- Do not exceed the Damage Level on the RF Input!
- Do not input signals with DC bias exceeding what the analyzer can tolerate while DC coupled!



Before connecting the signal to a spectrum analyzer (or any instrument) be sure that there is no charge on the cable and be aware of input limitations. These are usually printed close the terminals. Static precautions are usually observed very strictly in production environments and should be taken seriously in less structured situations. Although the effect of static discharge may be obvious if it destroys the instrument input, often the effect is gradual, causing a progressive deterioration in performance.

Specifications

Frequency Range

Description Specifications

Internal Mixing

Bands

| | |
|---|------------------|
| 0 | 3 Hz to 3.6 GHz |
| 1 | 3.5 to 8.4 GHz |
| 2 | 8.3 to 13.6 GHz |
| 3 | 13.5 to 17.1 GHz |
| 4 | 17 to 26.5 GHz |
| 5 | 26.4 to 34.5 GHz |
| 6 | 34.4 to 50 GHz |

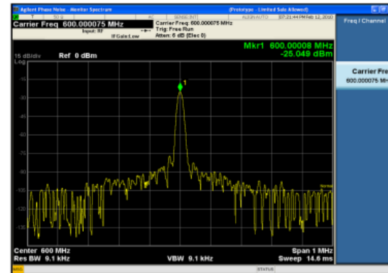

Frequency Range

Specifications

Accuracy: Frequency & amplitude

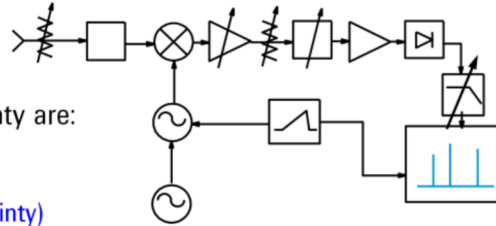

Components which contribute to uncertainty are:

- Input mismatch (VSWR)
- RF Input attenuator (Atten. switching uncertainty)
- Mixer and input filter (frequency response)
- IF gain/attenuation (reference level accuracy)
- RBW filters (RBW switching uncertainty)
- Log amp (display scale fidelity)
- Reference oscillator (frequency accuracy)
- Calibrator (amplitude accuracy)

Accuracy

Specifications

Absolute and Relative Accuracy: Frequency & Amplitude

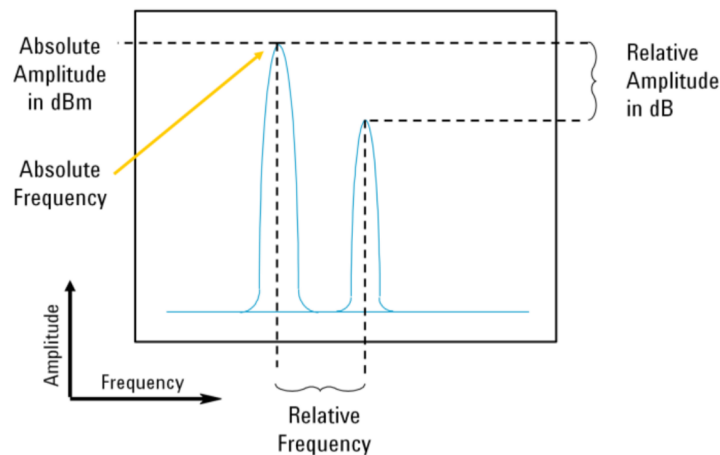

Note: Absolute accuracy is also “relative” to the calibrator reference point

28

Agilent Technologies

Back to Basics Training

The second area to understand is **accuracy**; how accurate will my results be in both frequency and amplitude? When talking about accuracy specifications, it is important to understand that there are both an absolute accuracy specification, and a relative accuracy specification.

The absolute measurement is made with a single marker. For example, the frequency and power level of a carrier for distortion measurements is an absolute measurement.

The relative measurement is made with the relative, or delta, marker. Examples include modulation frequencies, channel spacing, pulse repetition frequencies, and offset frequencies relative to the carrier. Relative measurements are more accurate than absolute measurements.

Let's begin by discussing frequency accuracy.

Specifications

Accuracy: Frequency Readout Accuracy

- From the PXA Data Sheet:

$$\pm (\text{marker frequency} \times \text{freq reference accuracy} + 0.1\% * \text{span} + 5\% \text{ of RBW} + 2\text{Hz} + 0.5 \times \text{Horiz. Res.} *)$$

Span Accuracy

RBW Error
IF filter center frequency error

Residual Error

*Horizontal resolution is span/(sweep points – 1)

Determined by Reference Accuracy

29

Agilent Technologies

Back to Basics Training

Frequency accuracy is often listed under the Frequency Readout Accuracy specification and is usually specified as the sum of several sources of errors, including frequency-reference inaccuracy, span error, and RBW center-frequency error.

Frequency-reference accuracy is determined by the basic architecture of the analyzer. The quality of the instrument's internal timebase is also a factor, however, many spectrum analyzers use an ovenized, high-performance crystal oscillator as a standard or optional component, so this term is small.

There are two major design categories of modern spectrum analyzers: synthesized and free-running. In a synthesized analyzer, some or all of the oscillators are phase-locked to a single, traceable, reference oscillator. These analyzers have typical accuracies on the order of a few hundred hertz. This design method provides the ultimate in performance with associated complexity and cost. Spectrum analyzers employing a free-running architecture use a simpler design and offer moderate frequency accuracy at an economical price. Free-running analyzers offer typical accuracies of a few megahertz. This may be acceptable in many cases. For example, many times we are measuring an isolated signal, or we need just enough accuracy to be able to identify the signal of interest among other signals.

Span error is often split into two specs, based on the fact that many spectrum analyzers are fully synthesized for small spans, but are open-loop tuned for larger spans. (The slide shows only one span specification.)

RBW error can be appreciable in some spectrum analyzers, especially for larger RBW settings, but in most cases it is much smaller than the span error.

Specifications

Accuracy: Frequency Readout Accuracy Example

Frequency: 1 GHz
Span: 400 kHz
RBW: 3 kHz
Sweep points: 1000

$$\begin{array}{rcl} \text{Calculation: } (1 \times 10^9 \text{ Hz}) \times (\pm 1.55 \times 10^{-7} / \text{Year ref. Error}) & = & \mathbf{155 \text{ Hz}} \\ 400 \text{ kHz Span} \times 0.1\% & = & \mathbf{400 \text{ Hz}} \\ 3 \text{ kHz RBW} \times 5\% & = & \mathbf{150 \text{ Hz}} \\ 2 \text{ Hz} + 0.5 \times 400 \text{ kHz} / (1000 - 1) & = & \mathbf{202 \text{ Hz}} \\ \text{Total uncertainty} & = & \mathbf{\pm 907 \text{ Hz}} \end{array}$$

*Utilizing internal frequency counter improves accuracy to $\pm 155 \text{ Hz}$

** The Maximum # of sweep points for the X-Series is 40,001 which helps to achieve the best frequency readout accuracy

30

Agilent Technologies

Back to Basics Training

Let's use the previous equation in an example to illustrate how you can calculate the frequency accuracy of your measurement. If we're measuring a signal at 1 GHz, using a 400 kHz span and a 3 kHz RBW, we can determine our frequency accuracy as follows:

Frequency reference accuracy is calculated by adding up the sources of error shown (all of which can be found on the datasheet):

$$\text{freq ref accuracy} = 1 \times 10^{-7} (\text{aging}) + 1.5 \times 10^{-8} (\text{temp stability}) + 4 \times 10^{-8} (\text{cal accuracy}) = 1.55 \times 10^{-7} / \text{yr. ref error}$$

Therefore, our frequency accuracy is:

$$\begin{array}{rcl} (1 \times 10^9 \text{ Hz}) \times (1.55 \times 10^{-7} / \text{yr}) & = & 155 \text{ Hz} \\ 0.1\% \text{ of } 400 \text{ kHz span} & = & 400 \text{ Hz} \\ 5\% \text{ of } 3 \text{ kHz RBW} & = & 150 \text{ Hz} \\ 2 \text{ Hz} + .5 \times \text{horizontal resolution} & = & 202 \text{ Hz} \\ \text{Total} & = & \mathbf{907 \text{ Hz}} \end{array}$$

Specifications

Accuracy: Key Amplitude Uncertainty Contributions

| <u>Relative and absolute:</u> | <u>PXA Uncertainties</u> |
|--|--------------------------|
| • Input impedance mismatch | (±0.13 dB) |
| • Input attenuator switching uncertainty | (±0.14 dB) |
| • Frequency response | (±0.35 dB) |
| • Reference level accuracy | (0 dB) |
| • RBW switching uncertainty | (±0.03 dB) |
| • Display scale fidelity | (±0.07 dB) |
| <u>Absolute only:</u> | |
| • Calibrator accuracy | (±0.24 dB) |

31

Agilent Technologies

Back to Basics Training

Let's now discuss *amplitude accuracy*.

Most spectrum analyzers are specified in terms of both absolute and relative amplitude accuracy. We will first discuss absolute accuracy and then compare that to relative measurement accuracy.

Absolute amplitude measurements are actually measurements that are relative to the calibrator, which is a signal of known amplitude. All modern spectrum analyzers have a calibrator built inside. This calibrator provides a signal with a specified amplitude at a given frequency. Since this calibrator source typically operates on a single frequency, we rely upon the relative accuracy of the analyzer to extend absolute calibration to other frequencies and amplitudes. A typical calibrator has an uncertainty of 0.3 dB. The calibrator is also at a single amplitude so the reference level uncertainty or the display scale fidelity also comes into play.

Let's examine these uncertainties in spectrum analyzers.

Specifications

Accuracy: Frequency Response

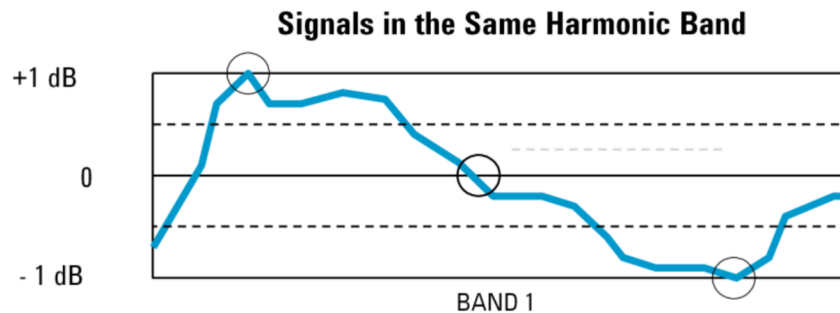

Absolute amplitude accuracy – Specification: ± 1 dB

Relative amplitude accuracy – Specification: ± 2 dB

The frequency response, or flatness of the spectrum analyzer plays a part in amplitude uncertainties and is frequency-range dependent. A low-frequency RF analyzer might have a frequency response which varies 0.5 dB. On the other hand, a microwave spectrum analyzer tuning in the 20 GHz range could well have a frequency response variation in excess of 4 dB.

The specification assumes the worst case situation, the full amplitude deviation over the whole frequency range, in this case plus 1 dB and minus 1 dB. In the case of absolute amplitude accuracy, we have one signal somewhere in this band and we are comparing it to the calibrator signal. We don't know where our signal is within this band, so we must apply the worst case frequency response uncertainty to our measurement.

Specifications

Accuracy: Display Fidelity

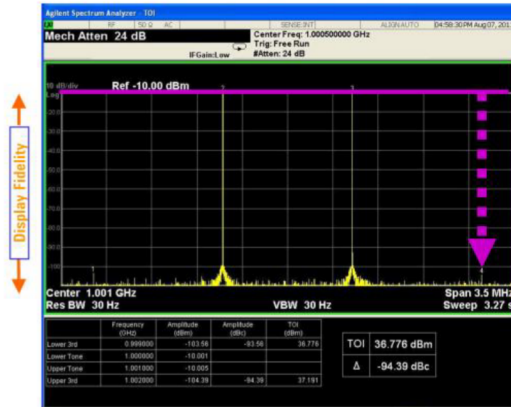

Display Fidelity includes:

- Log Amp Fidelity
- Envelope Detector Linearity
- Digitizing Circuit Linearity

Display fidelity error applies when signals are not at the same reference level amplitude when measured

In the past, technique for best accuracy was to move each measured signal to the reference line, eliminating display fidelity error.

Display Scale Fidelity of analyzers with digital IF are superior to those with analog IF i.e. X-series analyzers have +/- 0.1 db vs. ESA, 856xEC +/- 1.0 db

Display scale fidelity covers a variety of factors. Among them are the log amplifier (how true the logarithmic characteristic is), the detector (how linear), and the digitizing circuits (how linear). The LCD display itself is not a factor for those analyzers using digital techniques and offering digital markers because the marker information is taken from trace memory, not the display. The display fidelity is better over small amplitude differences, and ranges from a few tenths of a dB for signal levels close to the reference level to perhaps 2 dB for large amplitude differences. The top line or graticule is given absolute calibration and if your signal is at that level on the screen, the display fidelity uncertainty is at a minimum for that measurement.

The further your signal is from the reference level, the larger the display scale fidelity will play a factor. Given this piece of information, if your signal was placed on the bottom half of the screen, how could you reduce this error? One way would be bring your signal up to the reference level by changing the display settings of the spectrum analyzer.

Specifications

Amplitude Accuracy: Reference Level Switching

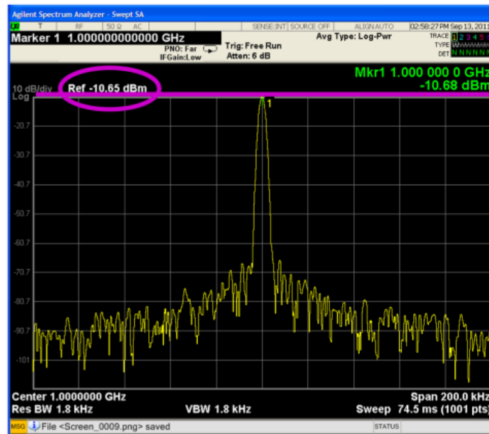

Uncertainty applies when changing the Ref. Level

Also called IF Gain Uncertainty

Decision: Do I change the reference level or live with the display fidelity uncertainty in my measurements?

However with today's X-series analyzers, provided the attenuation remains unchanged, the signal no longer needs to be at the reference level for the most accurate measurement.

To reduce the display fidelity uncertainty, you would need to bring the signal you are measuring up to the reference level. Now the displayed amplitude of your signal is the same as the calibrator. However, you have now introduced a new error in your measurement because the calibrator was measured with a specific reference level and it has now changed. When the reference level is changed, what is really changing is the IF gain so this error is also called the IF Gain Uncertainty.

A decision has to be made to determine what to do to get the best accuracy in your measurement. Do you leave the signal at the same place on the screen and have the display fidelity error, or do you move the signal to the reference level and cause a reference level switching error? The answer completely depends on what spectrum analyzer you are using. Some analyzers have larger display fidelity errors while others have larger IF Gain Uncertainties.

Specifications

Amplitude Accuracy - Summary

Optimize measurement setup & techniques for best accuracy

- **Minimize changes to uncertainty contributors**
 - Or change contributor with least error impact
 - Or stay within the optimum accuracy envelope parameters that modern auto-alignment calibration techniques provide
- **Traditionally, one technique for best accuracy was to move each measured signal to the reference line, eliminating display fidelity error. However, in today's designs, display fidelity has improved to the point where there is generally less error just to leave the signals where they occur on the display.**
- **Except for freq. response, uncertainty contributors that impact both signals equally in a relative measurement can be ignored.**
- **In the absence of specified relative freq. response, the relative response uncertainty is assumed to be 2x specified absolute error.**

Display Fidelity Error is comprised of log or linear amplifier fidelity, detector linearity, and ADC linearity.

A technique for improving amplitude accuracy is to place the first signal at a reference amplitude using the reference level control, and use the marker to read amplitude value. Then move the second signal to the same reference and calculate the difference.

This assumes that the Reference Level Uncertainty (changing the reference level) is less than the Display Fidelity Uncertainty.

Specifications Resolution

What Determines Resolution?

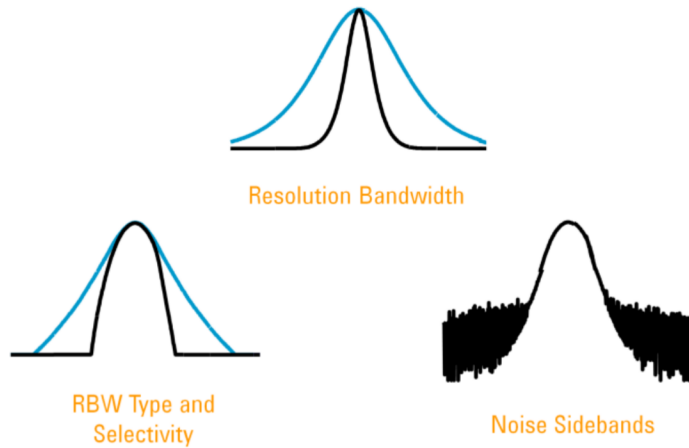

36

Agilent Technologies

Back to Basics Training

Resolution is an important specification when you are trying to measure signals that are close together and want to be able to distinguish them from each other. We saw that the IF filter bandwidth is also known as the resolution bandwidth (RBW). This is because it is the IF filter bandwidth and shape that determines the resolvability between signals.

In addition to filter bandwidth, the selectivity, filter type, residual FM, and noise sidebands (phase noise) are factors to consider in determining useful resolution. We shall examine each of these in turn.

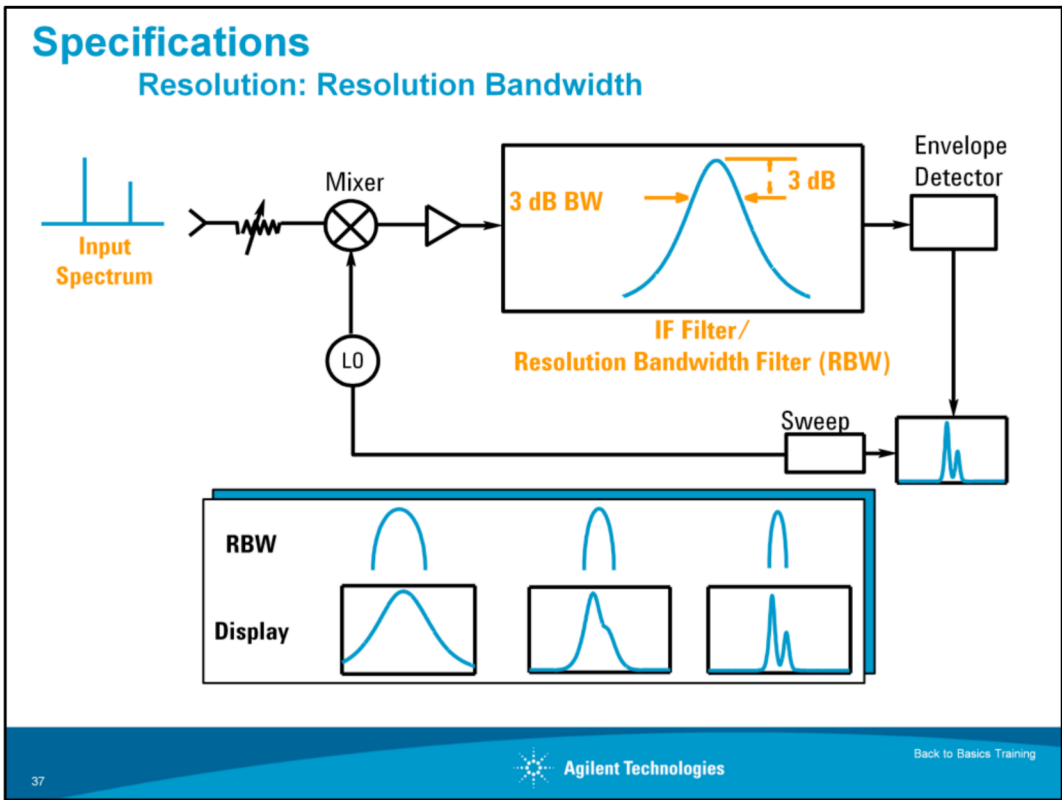

One of the first things to note is that a signal cannot be displayed as an infinitely narrow line. It has some width associated with it. This shape is the analyzer's tracing of its own IF filter shape as it tunes past a signal. Thus, if we change the filter bandwidth, we change the width of the displayed response. Agilent datasheets specify the 3 dB bandwidth. Some other manufacturers specify the 6 dB bandwidth.

This concept enforces the idea that it is the IF filter bandwidth and shape that determines the resolvability between signals.

Specifications

Resolution: Resolution BW

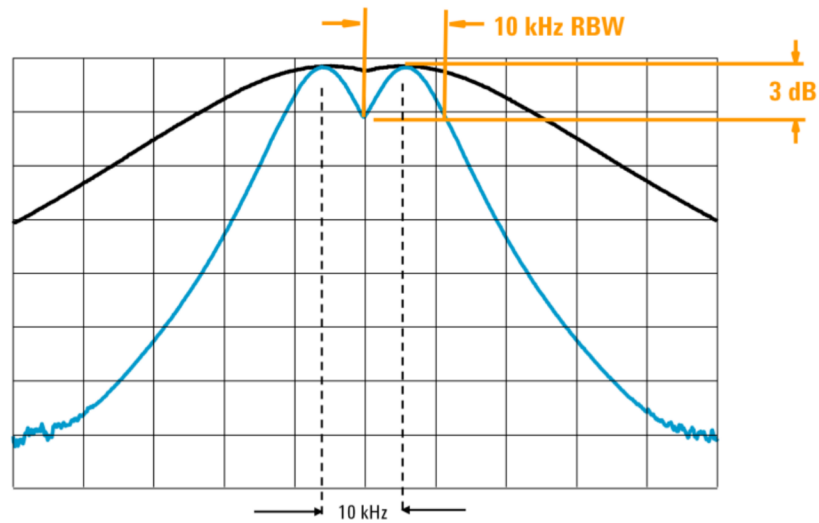

Determines resolvability of **equal** amplitude signals

When measuring two signals of equal-amplitude, the value of the selected RBW tells us how close together they can be and still be distinguishable from one another (by a 3 dB 'dip').

For example, if two signals are 10 kHz apart, a 10 kHz RBW will easily separate the responses. A wider RBW may make the two signals appear as one.

In general, two equal-amplitude signals can be resolved if their separation is greater than or equal to the 3 dB bandwidth of the selected resolution bandwidth filter.

Specifications

Resolution BW Selectivity or Shape Factor

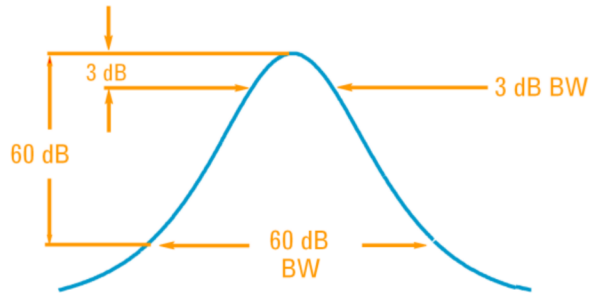

$$\text{Selectivity} = \frac{60 \text{ dB BW}}{3 \text{ dB BW}}$$

Determines resolvability of unequal amplitude signals

Selectivity is the important characteristic for determining the resolvability of unequal amplitude signals. Selectivity is the ratio of the 60 dB to 3 dB filter bandwidth. Typical selectivity ratios range from 11:1 to 15:1 for analog filters, and 5:1 for digital filters. X-Series has a digital filter. The filter selectivity is 4.1:1.

Usually we will be looking at signals of unequal amplitudes. Since both signals will trace out the filter shape, it is possible for the smaller signal to be buried under the filter skirt of the larger one. The greater the amplitude difference, the more a lower signal gets buried under the skirt of its neighbor's response.

This is significant, because most close-in signals you deal with are distortion or modulation products and, by nature, are quite different in amplitude from the parent signal.

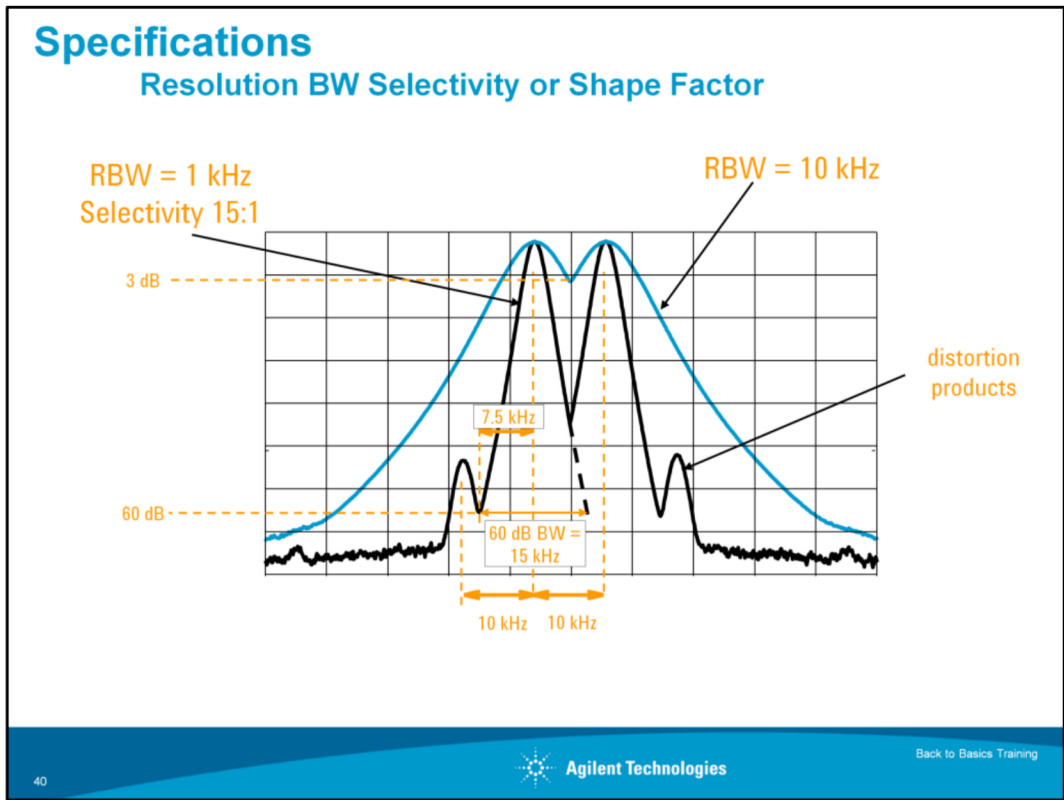

For example, say we are doing a two-tone test where the signals are separated by 10 kHz. With a 10 kHz RBW, resolution of the equal amplitude tones is not a problem, as we have seen. But the distortion products, which can be 50 dB down and 10 kHz away, could be buried.

Let's try a 3 kHz RBW which has a selectivity of 15:1. The filter width 60 dB down is 45 kHz (15 x 3 kHz), and therefore, distortion will be hidden under the skirt of the response of the test tone. If we switch to a narrower filter (for example, a 1 kHz filter) the 60 dB bandwidth is 15 kHz (15 x 1 kHz), and the distortion products are easily visible (because one-half of the 60 dB bandwidth is 7.5 kHz, which is less than the separation of the sidebands). So our required RBW for the measurement must be 1 kHz.

This tells us then, that two signals unequal in amplitude by 60 dB must be separated by at least one half the 60 dB bandwidth to resolve the smaller signal. Hence, selectivity is key in determining the resolution of unequal amplitude signals.

Specifications

Resolution: RBW Type and Selectivity

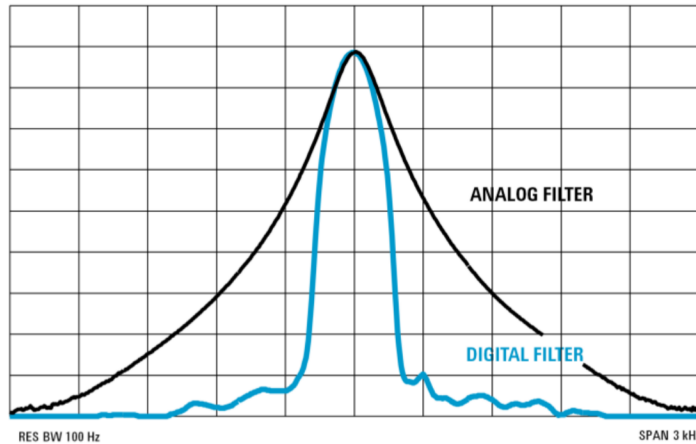

Typical Selectivity

Analog 15:1

Digital $\leq 5:1$

* The X-series RBW shape factor is 4.1:1

41

Agilent Technologies

Back to Basics Training

Digital RBWs (i.e. spectrum analyzers using digital signal processing (DSP) based IF filters) have superior selectivity and measurement speed. The following table illustrates this point. For example, with a 100 Hz RBW, a digital filter is 3.1 times faster than an analog.

| RBW | Speed Improvement |
|--------|-------------------|
| 100 Hz | 3.10 |
| 30 Hz | 14.40 |
| 10 Hz | 52.40 |
| 3 Hz | 118.00 |
| 1 Hz | 84.00 |

Specifications

Resolution: Noise Sidebands

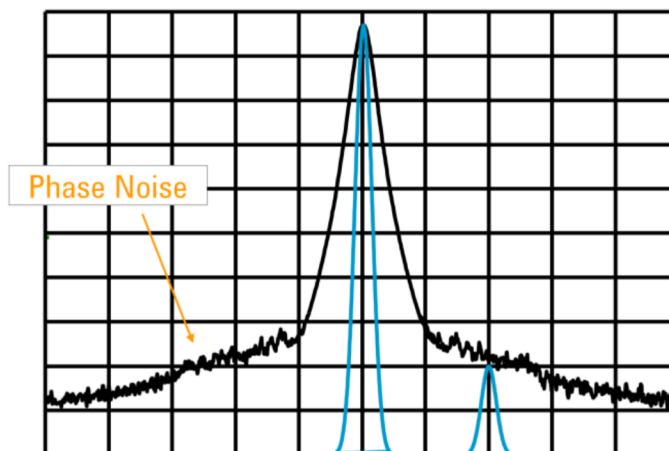

Noise Sidebands can prevent resolution of unequal signals

42

Agilent Technologies

Back to Basics Training

The remaining instability appears as *noise sidebands (also called phase noise)* at the base of the signal response. This noise can mask close-in (to a carrier), low-level signals that we might otherwise be able to see if we were only to consider bandwidth and selectivity. These noise sidebands affect resolution of close-in, low-level signals.

Phase noise is specified in terms of dBc or dB relative to a carrier and is displayed only when the signal is far enough above the system noise floor. This becomes the ultimate limitation in an analyzer's ability to resolve signals of unequal amplitude. The above figure shows us that although we may have determined that we should be able to resolve two signals based on the 3-dB bandwidth and selectivity, we find that the phase noise actually covers up the smaller signal.

Noise sideband specifications are typically normalized to a 1 Hz RBW. Therefore, if we need to measure a signal 50 dB down from a carrier at a 10 kHz offset in a 1 kHz RBW, we need a phase noise spec of -80 dBc/1Hz RBW at 10 kHz offset. Note: 50 dBc in a 1 kHz RBW can be normalized to a 1 Hz RBW using the following equation. $(-50 \text{ dBc} - [10 \cdot \log(1\text{kHz}/1\text{Hz})]) = (-50 - [30]) = -80 \text{ dBc}$.

Specifications

Resolution: RBW Determines Sweep Time

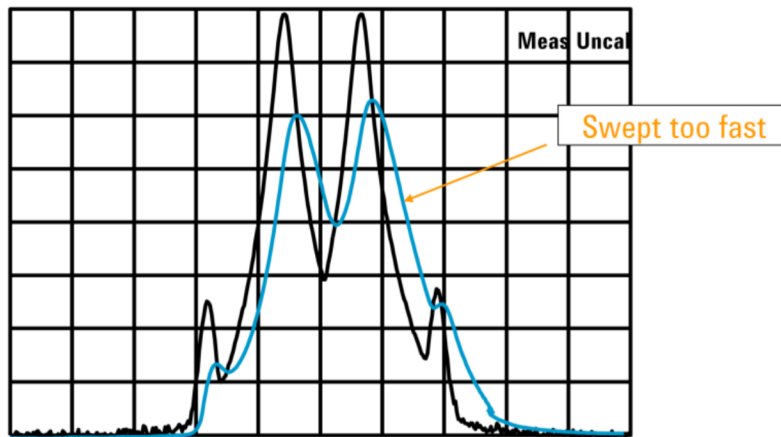

**Penalty For Sweeping Too Fast
Is An Uncalibrated Display**

43

Agilent Technologies

Back to Basics Training

When we narrow the resolution bandwidths for better resolution, it takes longer to sweep through them because they require a finite time to respond fully. When the sweep time is too short, the RBW filters cannot fully respond, and the displayed response becomes uncalibrated both in amplitude and frequency - the amplitude is too low and the frequency is too high (shifts upwards) due to delay through the filter.

Spectrum analyzers have auto-coupled sweep time which automatically chooses the fastest allowable sweep time based upon selected Span, RBW, and VBW. When selecting the RBW, there is usually a 1-10 or a 1-3-10 sequence of RBWs available (some spectrum analyzers even have 10% steps). More RBWs are better because this allows choosing just enough resolution to make the measurement at the fastest possible sweep time.

For example, if 1 kHz resolution (1 sec sweep time) is not enough resolution, a 1-3-10 sequence analyzer can make the measurement in a 300 Hz Res BW (10 sec sweep time), whereas the 1-10 sequence analyzer must use a 100 Hz Res BW (100 sec sweep time)!

Specifications

Resolution: RBW Type Determines Sweep Time

8563E Analog RBW

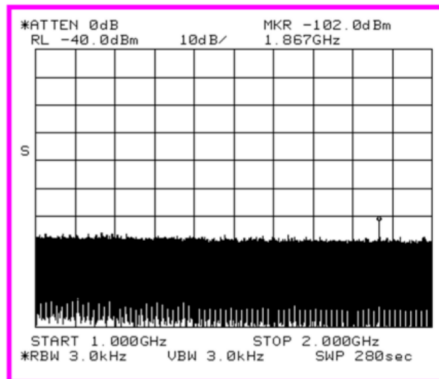

280 sec

PXA Swept RBW

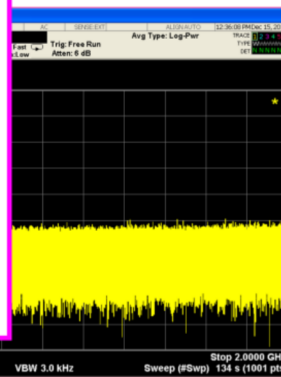

134 sec

PXA FFT RBW

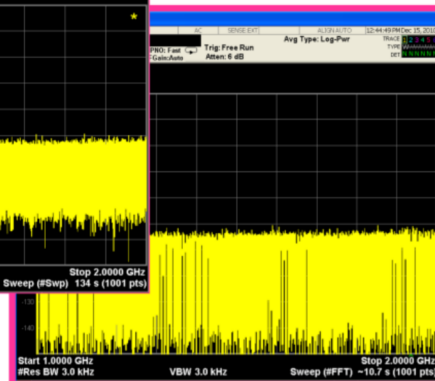

10.7 sec

The speed of a sweep for a spectrum analyzer is affected by whether it is a swept analog or digital analyzer or an FFT analyzer. Shown here screen shots comparing the sweep times for three types.

Long measurement times in swept spectrum analysis result from measurements that require a narrow RBW (and thus a more narrow span). This is necessary when trying to view a narrow signal (span less than 100 kHz) or performing measurements such as low level spurious searches where narrow RBW's are used to reduce the displayed average noise level.

The primary advantage of FFT analysis is measurement speed in measurements that require a narrow RBW and a comparatively wide frequency span. Remember that FFT processing can be thought of as many RBW filters in parallel. The settling time is similar to the swept case, but all of the filters are settling at the same time a faster measurement. In some cases, FFT processing can provide measurements 100 times faster than the swept case.

Specifications

Sensitivity/DANL

A Spectrum Analyzer Generates and Amplifies Noise Just Like Any Active Circuit

45
Agilent Technologies
Back to Basics Training

One of the primary uses of a spectrum analyzer is to search out and measure low-level signals. The **sensitivity** of any receiver is an indication of how well it can measure small signals. A perfect receiver would add no additional noise to the natural amount of thermal noise present in all electronic systems, represented by kTB (k =Boltzman's constant, T =temperature, and B =bandwidth). In practice, all receivers, including spectrum analyzers, add some amount of internally generated noise.

Spectrum analyzers usually characterize this by specifying the displayed average noise level (DANL) in dBm, with the smallest RBW setting. DANL is just another term for the noise floor of the instrument given a particular bandwidth. It represents the best-case sensitivity of the spectrum analyzer, and is the ultimate limitation in making measurements on small signals. An input signal below this noise level cannot be detected. Generally, sensitivity is on the order of -90 dBm to -145 dBm.

It is important to know the sensitivity capability of your analyzer in order to determine if it will adequately measure your low-level signals.

Specifications

Sensitivity/DANL

Sensitivity is the Smallest Signal That Can Be Measured

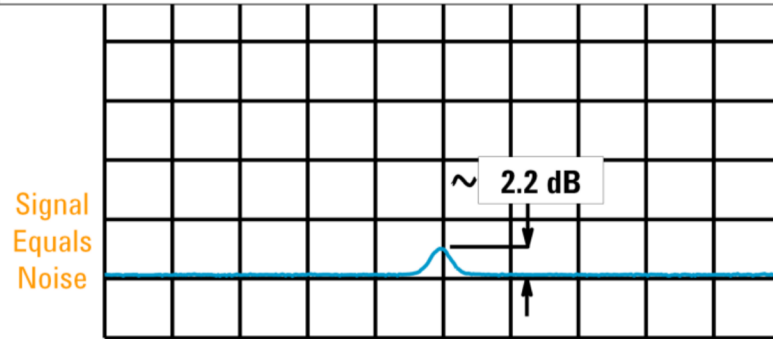

46

Agilent Technologies

Back to Basics Training

A signal whose level is equal to the displayed average noise level (DANL) will appear approximately as a 2.2 dB bump above the displayed average noise level. This is considered to be the minimum measurable signal level. However, you won't be able to see this signal unless you use video filtering to average the noise.

Spectrum analyzer sensitivity is specified as the DANL in a specified RBW.

Specifications

Sensitivity/DANL

Effective Level of Displayed Noise is a Function of RF Input Attenuation

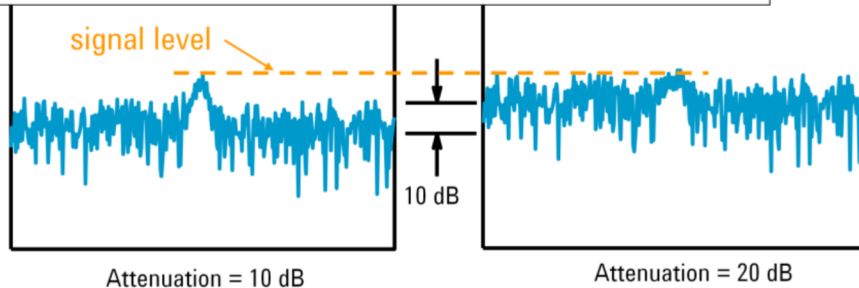

Signal To Noise Ratio Decreases as RF Input Attenuation is Increased

47

Agilent Technologies

Back to Basics Training

One aspect of the analyzer's internal noise that is often overlooked is its effective level as a function of the RF input attenuator setting. Since the internal noise is generated after the mixer, the RF input attenuator has no effect on the actual noise level. (Refer to the block diagram). However, the RF input attenuator does affect the signal level at the input and therefore decreases the signal-to-noise ratio (SNR) of the analyzer. The best SNR is with the lowest possible RF input attenuation.

Note in the figure, that the displayed signal level does not fall with increased attenuation. Remember from the theory of operation section that the RF input attenuator and IF gain are tied together. Therefore, as we increase the RF input attenuation 10 dB, the IF gain will simultaneously increase 10 dB to compensate for the loss. The result is that the on-screen signal stays constant, but the (amplified) noise level increases 10 dB.

Specifications

Sensitivity/DANL: IF Filter(RBW)

Displayed Noise is a Function of IF Filter Bandwidth

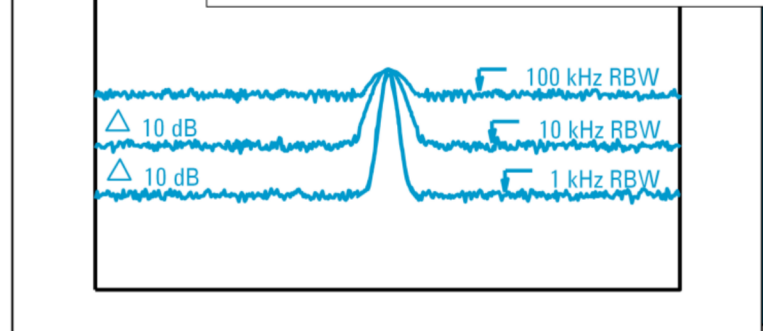

Decreased BW = Decreased Noise

48



Agilent Technologies

Back to Basics Training

This internally generated noise in a spectrum analyzer is thermal in nature; that is, it is random and has no discrete spectral components. Also, its level is flat over a frequency range that is wide in comparison to the ranges of the RBWs. This means that the total noise reaching the detector (and displayed) is related to the RBW selected. Since the noise is random, it is added on a power basis, so the relationship between displayed noise level and RBW is a ten log basis. In other words, if the RBW is increased (or decreased) by a factor of ten, ten times more (or less) noise energy hits the detector and the displayed average noise level (DANL) increases (or decreases) by 10 dB.

The relationship between displayed noise level and RBW is:

$$\text{noise level change (dB)} = 10 \log(\text{RBW}_{\text{new}}/\text{RBW}_{\text{old}})$$

Therefore, changing the RBW from 100 kHz (RBW_{old}) to 10 kHz (RBW_{new}) results in a change of noise level:

$$\text{noise level change} = 10 \log (10 \text{ kHz}/100 \text{ kHz}) = - 10 \text{ dB.}$$

Spectrum analyzer noise is specified in a specific RBW. The spectrum analyzer's lowest noise level (and slowest sweep time) is achieved with its narrowest RBW.

Specifications

Sensitivity/DANL: Video BW filter (or Trace Averaging)

Video BW or Trace Averaging Smooths Noise for Easier Identification of Low Level Signals

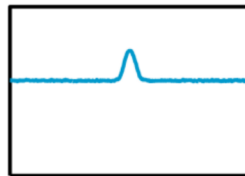
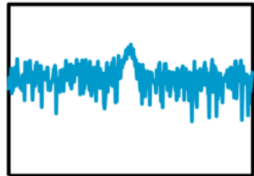

In the Theory of Operation section, we learned how the video filter can be used to smooth noise for easier identification of low level signals. Since we are talking about measuring low level signals, we will repeat it here. The VBW, however, does not affect the frequency resolution of the analyzer (as the RBW does), and therefore changing the VBW *does not improve sensitivity*. It does, however, improve discernability and repeatability of low signal-to-noise ratio measurements.

Specifications

Sensitivity/DANL:

Signal-to-Noise Ratio Can Be Graphed

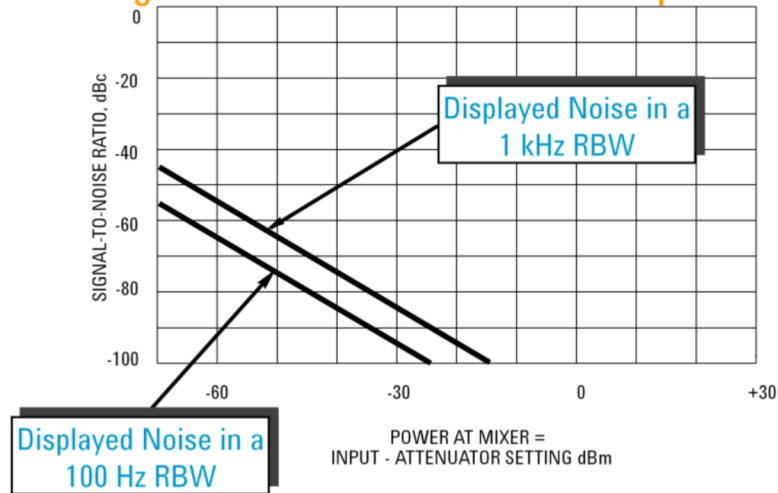

50

Agilent Technologies

Back to Basics Training

On page 54, we will plot the signal-to-distortion curves. This graph is actually called a dynamic range graph, and just as we will plot distortion products as a function of mixer power, we can also plot *signal-to-noise ratio* (SNR) as a function of mixer power.

The signal-to-distortion curves tell us that maximum dynamic range for distortion (minimum distortion in dBc) occurs at a minimum power level to the input mixer. We know, however, that spectrum analyzer noise also affects dynamic range. The dynamic range graph for noise (above) tells us that best dynamic range for noise occurs at the highest signal level possible.

We have a classic engineering trade-off. On the one hand, we would like to drive the level at the mixer to be as large as possible for the best signal-to-noise ratio. But on the other hand, to minimize internally generated distortion, we need as low a drive level to the mixer as possible. Hence the best dynamic range is a compromise between signal-to-noise and internally generated distortion.

Specifications

Sensitivity/DANL: Summary

For Best Sensitivity Use:

- **Narrowest Resolution BW**
- **Minimum RF Input Attenuation**
- **Sufficient Averaging (video or trace)**
- **Using the Preamp also improves sensitivity**
- **Low Noise Path (PXA only)**
- **Noise Floor Extension (PXA only)**

Based on what we've learned, we can see that the best sensitivity is achieved at:

1. narrowest RBW (decreases noise)
2. minimum RF Input Attenuation (increases signal)
3. using sufficient averaging; either Video Filtering or Trace Averaging or Both!
(to be able to see and read the small signal)
(VBW less than or equal to 0.1 to 0.01 RBW)
4. Preamp (reduces noise floor)
5. Low noise Path and Noise Floor Extension (decreases Noise on PXA only)

Note however, that best sensitivity may conflict with other measurement requirements.

For example, smaller RBWs greatly increase measurement time.
Also, zero dB input attenuation increases mismatch uncertainty therefore decreasing measurement accuracy.

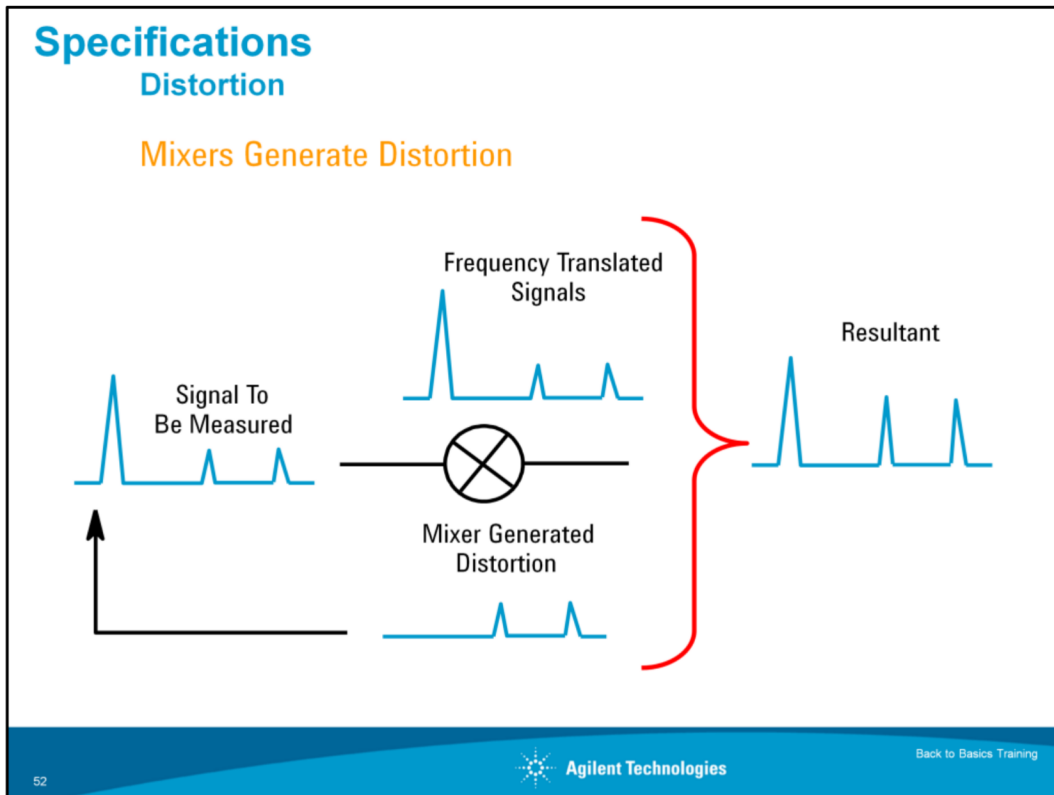

Although distortion measurements, such as third order intermodulation and harmonic distortion, are common measurements for characterizing devices, the spectrum analyzer itself will also produce distortion products, and potentially disturb your measurement. The **distortion** performance of the analyzer is specified by the manufacturer, either directly or lumped into a dynamic range specification, as we will see shortly.

Because mixers are non-linear devices, they will generate internal distortion. This internal distortion can, at worst, completely cover up the external distortion products of the device. But even when the internal distortion is below the distortion we are trying to measure, internal distortion often causes errors in the measurement of the (external) distortion of the DUT.

As we will see, the internally generated distortion is a function of the input power, therefore, there is no single distortion specification for a spectrum analyzer. We need to understand how distortion is related to the input signal, so that we can determine for our particular application, whether or not the distortion caused by the analyzer, will affect our measurement.

Specifications

Distortion

Most Influential Distortion is the Second and Third Order

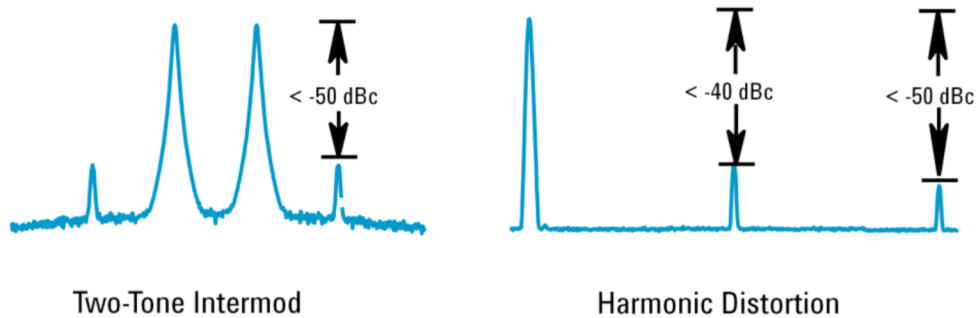

53

Agilent Technologies

Back to Basics Training

The critical question is, how much internal distortion is too much? The measurement itself determines how much distortion is too much. If the test itself specified that you must be able to view say, two-tone distortion products (third order products) more than 50 dB and second order (harmonic) distortion more than 40 dB below the fundamental, then this would set the minimum levels necessary for the analyzer specifications. To reduce measurement error caused by the presence of internal distortion, the internal distortion must actually be much lower than the test specifications.

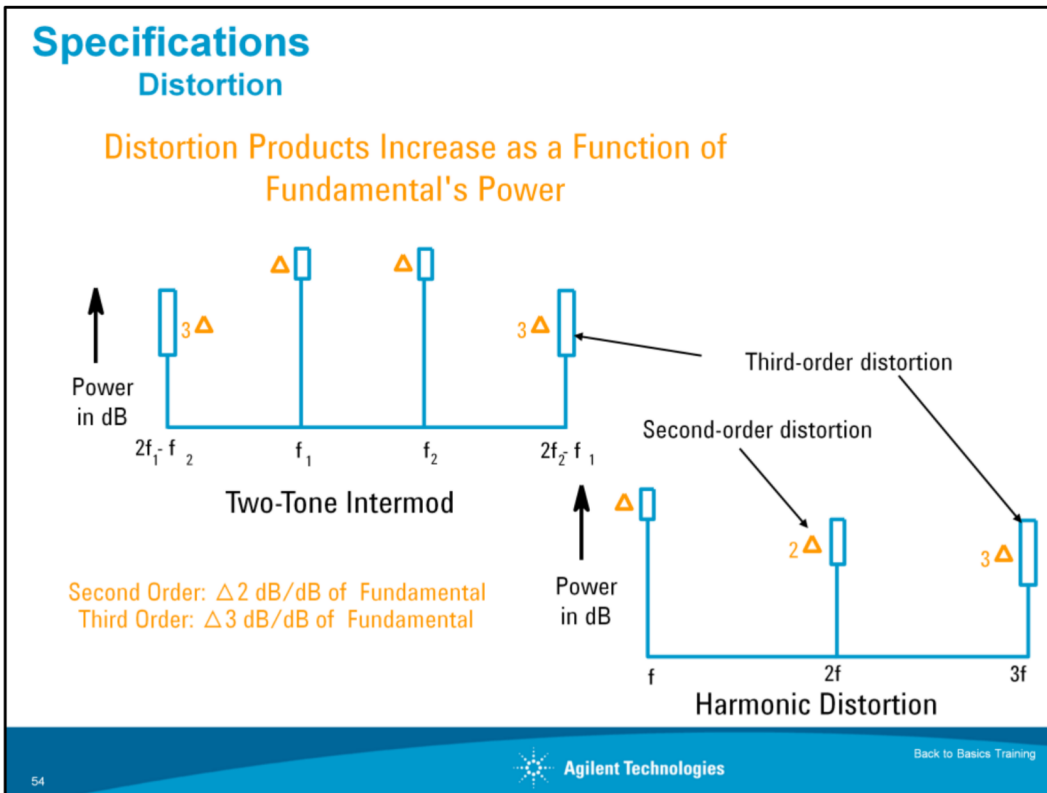

The behavior of distortion for any nonlinear device, whether it be the internally generated distortion of the spectrum analyzer's first mixer or the distortion generated by your device under test is shown in the slide. The second-order distortion increases as a square of the fundamental, and the third-order distortion increases as a cube. This means that on the log scale of our spectrum analyzer, the level of the second-order distortion will change twice as fast as the fundamental, and the third-order distortion will change three times as fast.

Most distortion measurements are made relative to the fundamental signals (the carrier or two-tones). When the fundamental power is decreased 1 dB, the second-order distortion decreases by 2 dB, but relative to the fundamental, the second-order distortion decreases 1 dB. There is a one-for-one relative relationship between the fundamental and second-order distortion.

When the fundamental power is decreased 1 dB, the third-order distortion decreases 3 dB, but relative to the fundamental, the third-order distortion decreases 2 dB. There is a two-for-one relative relationship between the fundamental and third-order distortion.

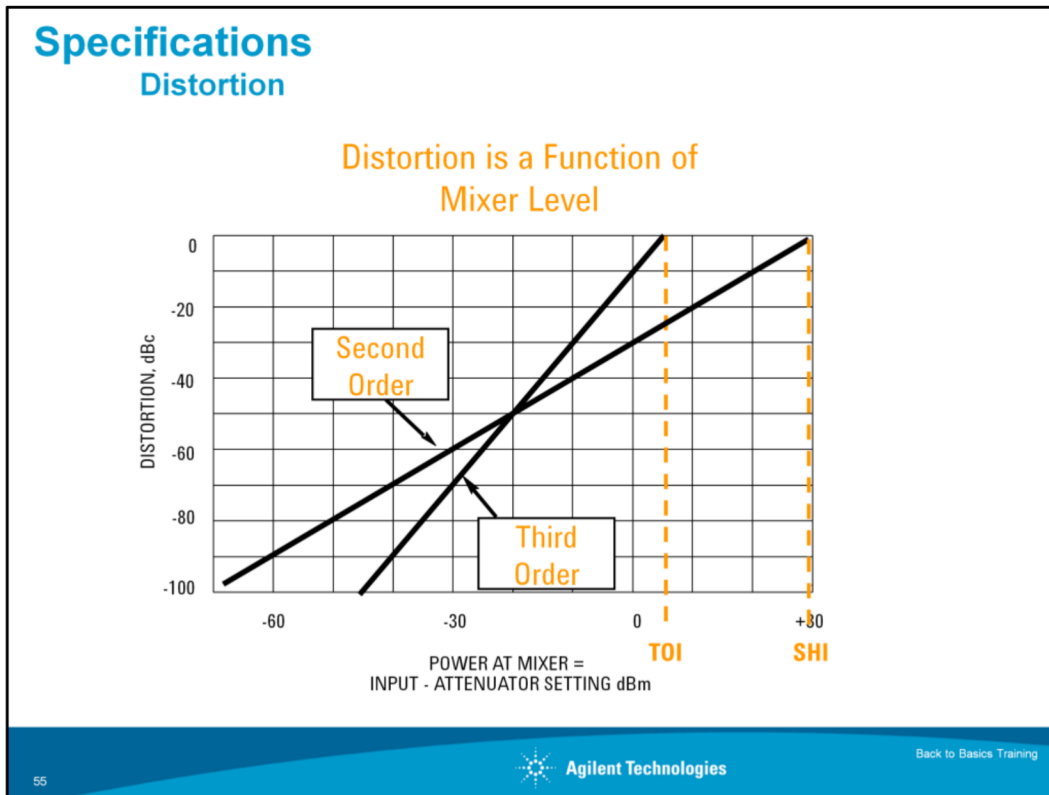

Understanding this concept is useful in determining distortion within the analyzer. Here we plot the level of the second- and third-order distortion products relative to the signals that cause them. The x-axis is the signal power at the first mixer (in this case the level of the tone or tones). The y-axis is the spectrum analyzer's internally-generated distortion level in dBc (dB below the signal level at the mixer). These curves are *signal-to-distortion curves*.

Note the slopes of the second- and third-order curves. The slope is unity for the second-order, because every dB change in fundamental level equally changes the level of the second harmonic-distortion component relative to the fundamental. The third-order curve has a slope of two because the relationship between fundamental and third-order distortion products changes twice as fast as the fundamental. Thus, if analyzer distortion is specified for one signal level at the mixer, distortion at any other level can easily be determined. This example shows that for a level of -40 dBm at the mixer, third-order distortion is -90 dBc and second-order distortion is -70 dBc.

The mixer level at which third-order distortion equals the fundamental, 0 dBc, (a condition which could never happen because compression in the mixer would occur first) is useful to know because a simple expression then permits computation of third-order distortion at any mixer level. This reference point is called the third-order intercept or TOI. This is a common spectrum analyzer specification, and is used to determine the maximum dynamic range available for a particular measurement. In the above figure, TOI = +5 dBm.

Specifications

Distortion – Internal or External?

Attenuator Test:
Change power to the mixer

- ① Change input attenuator by 10 dB
- ② Watch distortion amplitude on screen

No change in amplitude: distortion is part of input signal (external)

Change in amplitude: at least some of the distortion is being generated inside the analyzer (internal)

■ Original distortion signal
■ Signal with 10dB input attenuation

Before leaving this section on distortion, there is a test that should be done for all distortion measurements which will tell us whether or not what we are seeing on the screen is internally generated distortion, or distortion caused by the DUT.

Remember that the RF input attenuator and the IF gain are tied together such that input signals will remain stationary on the screen when we adjust the RF input attenuation. So let's change the RF input attenuation and see what happens.

If the distortion product on the screen does not change, we can be sure it is distortion from the DUT (i.e. part of the input signal). The 10 dB attenuation applied to the signal is also experiencing the 10 dB gain from the IF gain and therefore, there is no change.

If however, the signal on the screen does change, then we know it must be being generated, at least in part, somewhere after the input attenuator, and not totally from the DUT. The 10 dB attenuation is not applied to this internal signal (since it is actually generated after the attenuator), yet the 10 dB gain is applied to it, therefore increasing its level by as much as 10 dB.

Specifications

Spectrum Analyzer Dynamic Range

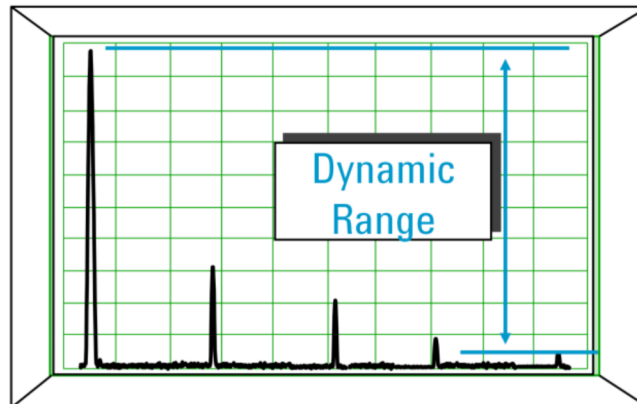

The ratio, expressed in dB, of the largest to the smallest signals simultaneously present at the input of the spectrum analyzer that allows measurement of the smaller signal to a given degree of uncertainty.

Dynamic Range is defined as the maximum ratio of two signal levels simultaneously present at the input which can be measured to a specified accuracy. You can imagine connecting two signals to the analyzer input - one which is the maximum allowable level for the analyzer's input range and the other which is much smaller. The smaller one is reduced in amplitude until it is no longer detectable by the analyzer. When the smaller signal is just measurable, the ratio of the two signal levels (in dB) defines the dynamic range of the analyzer.

What effects might make it undetectable? All the things we've just discussed. Such things as residual responses of the analyzer, harmonic distortion of the large signal (due to analyzer imperfections), and the internal noise of the analyzer. These will all be large enough to cover up the smaller signal as we decrease its amplitude. The dynamic range of the instrument determines the amplitude range over which we can reliably make measurements.

Specifications

Dynamic Range

Dynamic Range Can Be Presented Graphically

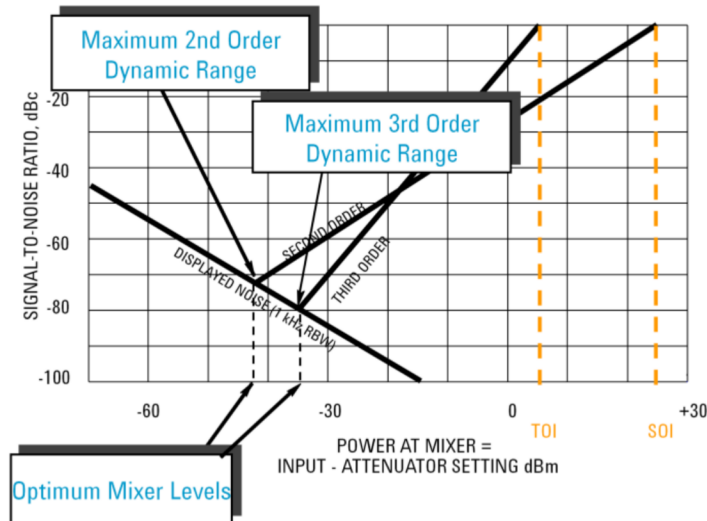

Let's plot both the signal-to-noise and signal-to-distortion curves on one dynamic range graph. *Maximum dynamic range* occurs where the curves intersect, that is, when the internally generated distortion level equals the displayed average noise level. This shows two of the dynamic range specifications. We will see that there are others later.

The *optimum mixer level* occurs at the point of maximum dynamic range. If our test tones are at 0 dBm and our attenuator has 10 dB steps, we can choose mixer levels of 0, -10, -20, -30, -40 dBm, etc. Many of these mixer levels will give us enough dynamic range to see third-order distortion products at -50 dBc. However, keeping the internal noise and distortion products as low as possible will minimize errors. A drive level to the mixer between -30 and -40 dBm would allow us to make the measurement with minimum error.

So, which mixer level do we choose? For < 1 dB uncertainty in your measurement, the signal-to-internal-distortion must be 19 dB, whereas the signal-to-noise only 5 dB. This tells us that it is best to stay closer to the noise, so we would set mixer level to -40 dBm (the mixer level to the left of the third-order point of intersection). This results in a "*spurious free display*".

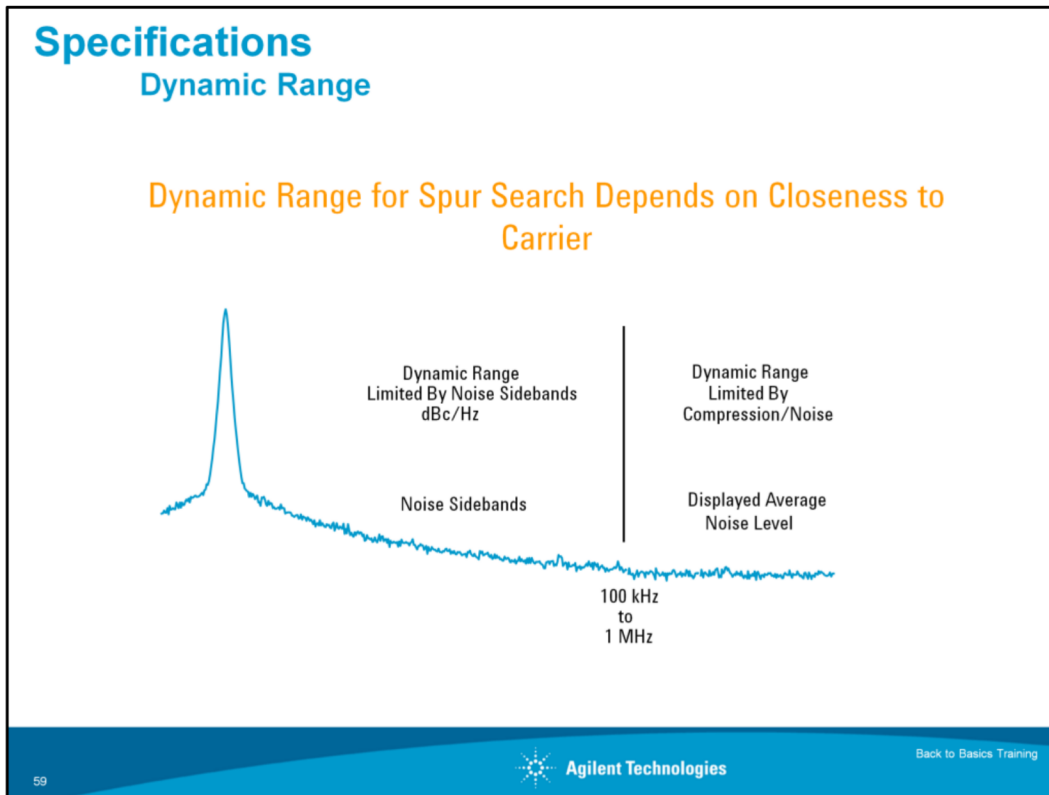

The final factor in dynamic range is the phase noise, or noise sidebands, on our spectrum analyzer LO.

An example application where we can see how both the noise sidebands and the DANL limits dynamic range is when making spur measurements. As shown on the slide, the dynamic range for the close-in, low-level spurs is determined by the noise sidebands within approximately 100 kHz to 1 MHz of the carrier (depending on carrier frequency). Beyond the noise sidebands, the dynamic range is limited by DANL

Another example is when the signals are so close together that noise sidebands limit dynamic range (e.g. a two-tone measurement where the tones are separated by 10 kHz, therefore producing third-order distortion products 10 kHz from the test tones).

For distortion tests, the phase noise can also be plotted on the dynamic range graph as a horizontal line at the level of the phase noise specification at a given offset.

NOTE: The dynamic range curves we've just discussed are needed only for distortion tests.

Specifications

Dynamic Range – Distortion, Noise Floor, LO phase noise

Dynamic Range is actually:

Maximum dynamic range calculation

Calculated from distortion products and sensitivity/DANL

bounded by

-dBc/Hz Phase Noise sidebands @ close-in offset frequencies

Determined by the phase noise specifications of the SA

We have seen that the dynamic range of a spectrum analyzer is limited by three factors: the broadband noise floor (sensitivity) of the system, the distortion performance of the input mixer, and the phase noise of the local oscillator.

The first two factors are used to calculate maximum dynamic range. Therefore, actual dynamic range is the minimum of 1) the MDR calculation and 2) the noise sidebands.

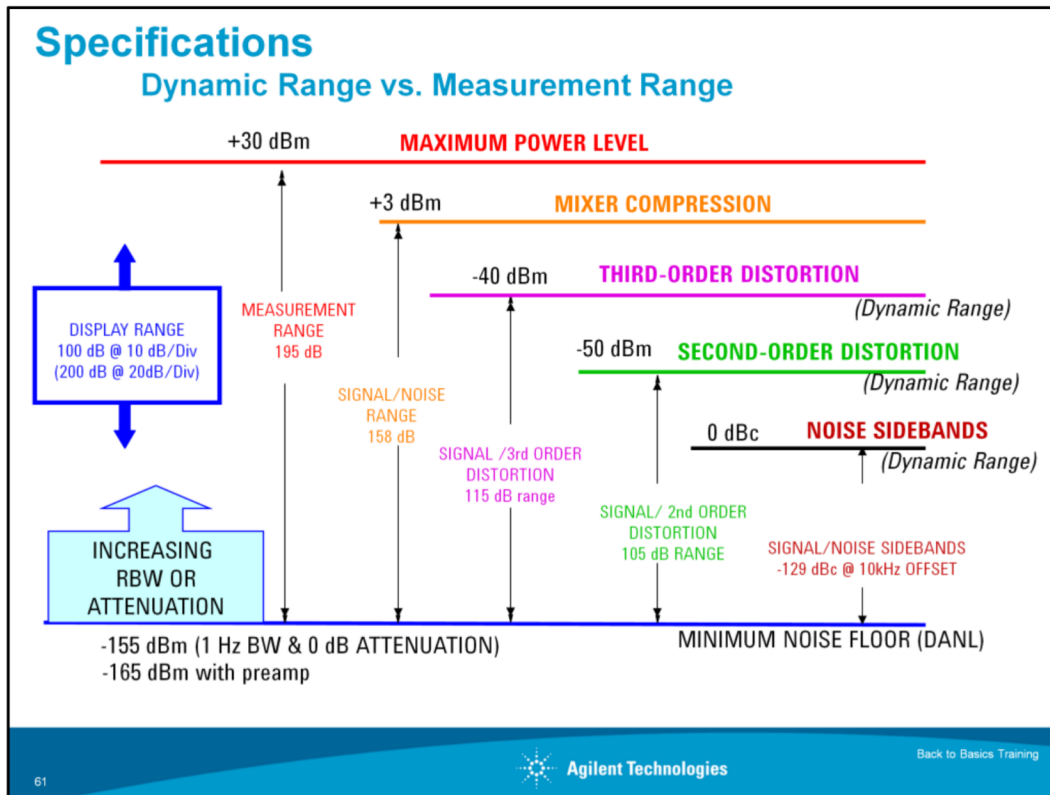

Different people have different definitions for dynamic range. Be certain that you know which one is appropriate for your application. There are several ranges associated with the spectrum analyzer. Typically the term "dynamic range" only refers to the ability to measure two signals *at the same time*.

Display range refers to the *calibrated* amplitude range of the LCD display. The calibrated display range is dependent on the calibrated range of the log amplifier.

Measurement range is the ratio of the largest to the smallest signal that can be measured under any circumstances - *but not at the same time*. The upper limit is determined by the maximum safe input level, +30 dBm (1 Watt) for most analyzers. Sensitivity or the displayed average noise level sets the other end of the range.

The other four ranges (signal/noise, signal/third order distortion, signal/second order distortion, and signal/noise sidebands) are when measuring two signals at the same time, and therefore are called dynamic range specifications. Because, in EMC, we are often attempting to measure a signal while in the presence of a larger ambient signal that can cause the mixer to go into compression the Signal/Noise range is the definition we are most interested in.

The comparison of the four dynamic range values for the PXA are above. As you can see, the noise sidebands (or phase noise) limit the dynamic range the most, whereas the spectrum analyzer noise floor (sensitivity) limits it the least.

Specifications

Summary: Optimizing Dynamic Range

•What settings provide the best sensitivity?

- Narrowest resolution bandwidth
- Minimal input attenuation
- Sufficient averaging

•How do you test for analyzer distortion?

- Increase the input attenuation and look for signal amplitude changes
- Then set the attenuator at the lowest setting without amplitude change

•What determines dynamic range?

- Analyzer distortion, noise level, and sideband/phase noise

Agenda

Introduction

Overview

Theory of Operation

Specifications

Modern spectrum analyzer designs & capabilities

- Wide Analysis Bandwidth Measurements

Wrap-up

Appendix

Now that we have a fairly basic understanding of the important characteristics of a spectrum analyzer, let's take a look at some of the features and abilities of a spectrum analyzer as it pertains to measurements on digitally modulated carriers. Most radios use digital modulation now and it's important to get a basic understanding of some of the differences between traditional analog modulation measurements and digital modulation measurements.

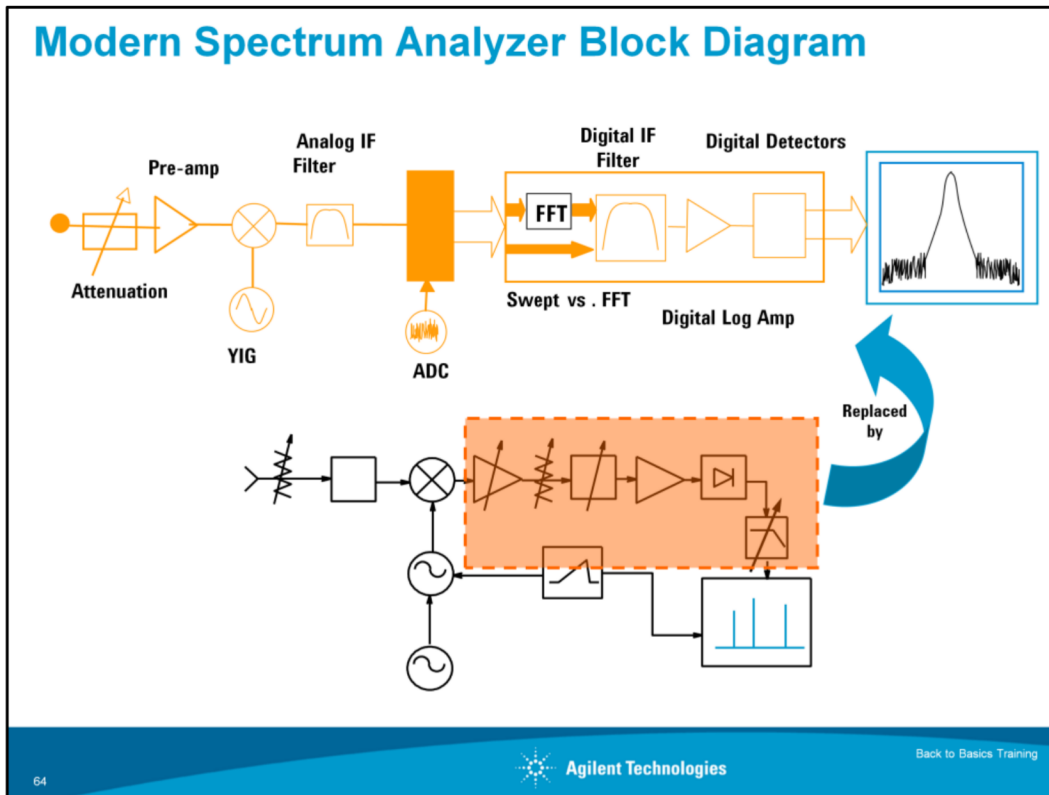

A modern spectrum analyzer will not have the same components as the traditional block diagram discussed in the previous slides. Rather, most of the blocks are the same but are re-arranged. Advances in ADC and DSP technology has not only benefited the ability of FFT analyzers to be useful, it has also made swept analyzers that much more powerful.

Shown here is the block diagram for a high-performance spectrum analyzer from Agilent called the PXA. The biggest change in the design of this spectrum analyzer, when compared to the older designs, is that the ADC is pushed much further up the processing chain so that all of the IF components are digital blocks instead of analog components. This all-digital IF allows great advances in the ability to process signals in different ways, gain advances in accuracy, dynamic range, and speed.

One thing to note now about the design is that immediately following the ADC is the choice to process the signals as a swept analyzer or as an FFT analyzer. Based on what you want to do with your signals, you may want to process the data one way or another. For example, if dynamic range is important to your measurement you will probably use the swept analysis. If you need faster sweep speed at narrow bandwidths, the FFT analysis is what you would use.

Modern Spectrum Analyzer Features

Application Focused Internal Software (one-button measurements)

General purpose applications

Flexible digital modulation analysis

Power & digital modulation measurements for wireless comms formats

| |
|--------------------------|
| Phase noise |
| Ext. source control |
| Noise figure |
| Code compatibility suite |
| EMI pre-compliance |
| Analog demod |
| Flexible demod |
| LTE FDD, TDD |
| W-CDMA/HSPA/HSPA+ |
| GSM/EDGE/EDGE Evo |
| cdma2000 & 1xEV-DO |
| cdmaOne |
| DVB-T/H/C/T2 |
| TD-SCDMA/HSPA |
| WLAN (802.11a/b/g/p/j) |
| 802.16 OFDMA |
| Bluetooth |

- ACPR, Multi-carrier Power
- Occupied Bandwidth (OBW)
- Spectral Emissions Mask
- Phase and Freq. (PFER)
- Mod Accuracy (Rho)
- Code Domain Power
- ORFS (GSM/EDGE)
- Spurious Emissions
- Power vs Time
- Channel power
- IM distortion
- CCDF
- ACPR
- EVM
- SEM

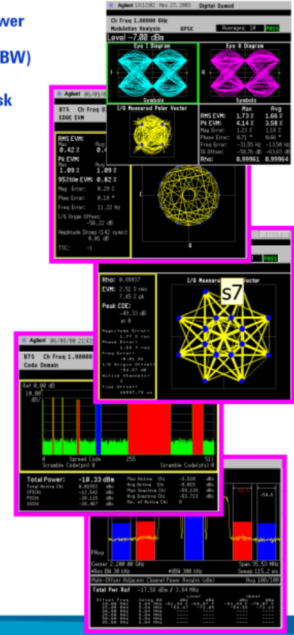

Agilent Vector Signal Analysis Software

89600B VSA Software

- FFT-based spectrum, time-domain & bit-level modulation analysis
- Support for more than 70 signal standards and modulation types
- 20:20 trace/marker capability and arbitrary window arrangement
- Digital persistence and cumulative history displays

- Wireless networking: 802.11a/b/g/n, 802.16 OFDMA, WiMAX...
- Cellular: LTE (FDD/TDD), W-CDMA HSPA+, GSM/EDGE Evolution
- Custom OFDM modulation analysis for proprietary signals

- Links to over 30 hardware platforms including: *X-series signal analyzers, 16800 logic analyzers, 90000 X-series scopes, Infiniium scopes, VXI*
- Runs on external PC linked to hardware or embedded operation on instruments with Windows OS

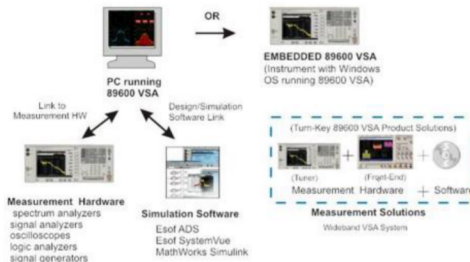
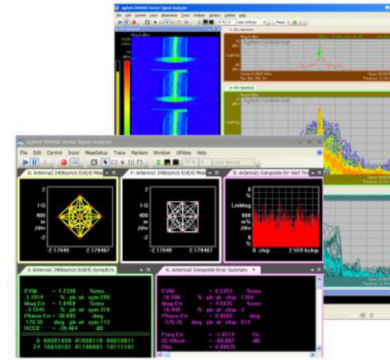

Agenda

Introduction

Overview

Theory of Operation

Specifications

Modern spectrum analyzer designs & capabilities

- Wide Analysis Bandwidth Measurements

Wrap-up

Appendix

Basic Spectrum Analyzer Application & Product Notes

[A.N. 150 – Spectrum Analysis Basics](#): #5952-0292EN

[A.N. 150-15 - Vector Signal Analysis Basics](#): #5989-1121EN

[Spectrum Analyzer & Signal Analyzer Selection Guide](#): #5968-3413E

[PXA Brochure](#): 5990-3951EN

[MXA Brochure](#): 5989-5047EN

[EXA Brochure](#): 5989-6527EN

[CXA Brochure](#): 5990-3927EN

[89600B Brochure](#): 5990-6553EN

[N9342,43,44C Brochure](#): 5990-8024EN

www.agilent.com/find/sa

More information about spectrum analysis measurements and vector signal analyzers can be obtained from the above sources:

Agenda

Introduction

Overview

Theory of Operation

Specifications

Modern spectrum analyzer designs & capabilities

- Wide Analysis Bandwidth Measurements

Wrap-up

Appendix

M1970V/W WAVEGUIDE HARMONIC MIXERS

New mixer family

- M1970V Option 001 (50 to 75 GHz)
- M1970V Option 002 band (50 to 80 GHz)
- M1970W (75 to 110 GHz)

Mixer smart features

- Automatic amplitude correction and transfer of conversion loss data through USB plug and play features
- Automatic LO amplitude adjustment to compensate the cable loss (up to 3 m or 10 dB loss)
- Auto detect mixer model/serial number when used with N9030A PXA signal analyzer
 - Automatic setting of default frequency range and LO harmonic numbers
 - Automatic LO alignment at start up
 - Automatic run calibration when time and temperature changes

Improved DANL and TOI

- Excellent conversion loss of 25 dB maximum and excellent amplitude calibration accuracy of 2.2 dB



Go smart with harmonic mixing!

Externally mixed measurements have always required extra steps, and some extra care, in terms of setup and verification. In addition, transferring the required conversion loss table to the analyzer can be tedious. The combination of the PXA and Agilent's new M1970V and M1970W waveguide harmonic mixers improves measurement performance and reliability, along with ease-of-use, in a number ways.

To begin with, the mixer connection is simpler and more reliable, requiring only a USB connection and a single coaxial cable between the analyzer and the mixer. The individual mixer (model and serial number), its frequency range and conversion loss table are identified and downloaded automatically. The LO connection is verified by the mixer's measurement of the LO input power. The mixer monitors the input LO power, adjusting it to compensate for cable losses and improving measurement accuracy. As a result, amplitude accuracy in the millimeter band improves, with uncertainties dropping to approximately half their previous levels. Phase noise and noise figure performance also improve because the higher LO frequencies available from the PXA allow the use of lower harmonic numbers.

Note the M1970V/W waveguide harmonic mixers are available for order now. Shipment starts in Q4.

M1970V option 001: not-to-exceed reference price: \$7934

M1970V option 002: not-to-exceed reference price: \$9517

M1970W: not-to-exceed reference price: \$8898

PXA Block Diagram

PXA Simplified Block Diagram (160 MHz BW)

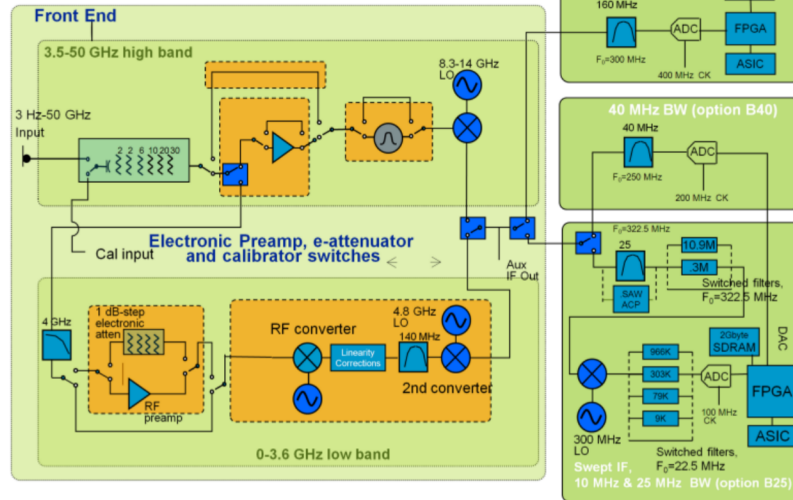

160 MHz Path
 ADC Nominal bits: 14
 ADC Effective bits: 11.2
 SFDR: up to 75 dBc

The Standard (10 MHz) & option B25 (25 MHz) path has a 16 bit ADC with a 100 MHz clock.

The option B40 (40 MHz) path has a 12 bit ADC with a 200 MHz clock.

The option B1X (160 MHz) path has a 14 bit ADC with a 400 MHz clock.

If you purchase B25; you get the 16 bit ADC.

If you purchase B40, you get the 16 bit ADC (usable to 25 MHz BW) and the 12 bit ADC (usable to 40 MHz).

If you purchase B1X; you get all three ADC paths.

The End

THANK YOU!