



Leica ScanStation P40/P30 System Field Manual

Version 5.0
English

- when it has to be **right**

Leica
Geosystems

Introduction



To use the product in a permitted manner, please refer to the detailed safety directions in the User Manual.

Purchase

Congratulations on the purchase of a Leica ScanStation P40/P30 instrument.

Product Identification

The type and serial number of your product are indicated on the type plate. Always refer to this information when you need to contact your agency or Leica Geosystems authorised service workshop.

Symbols

The symbols used in this manual have the following meanings:

Type	Description
	Important paragraphs which must be adhered to in practice as they enable the product to be used in a technically correct and efficient manner.



Trademarks

- Windows is a registered trademark of Microsoft Corporation
All other trademarks are the property of their respective owners.
-

Validity of this manual

This manual applies to the Leica ScanStation P40/P30 instruments.

Available documentation

Name	Description/Format		
Leica ScanStation P40/P30 Quick Guide	Provides an overview of the product together with technical data and safety directions. Intended as a quick reference guide.	✓	✓
Leica ScanStation P40/P30 User Manual	All instructions required in order to operate the product to a basic level are contained in the User Manual. Provides an overview of the product together with technical data and safety directions.	-	✓
Leica ScanStation P40/P30 System Field Manual	Describes the general operation of the product in standard use. Intended as a quick reference field guide.	-	✓
Leica Geosystems HDS Training Manual	Training manual provided in the Leica HDS training course by the local Leica HDS training and support team.		

Refer to the following resources for all Leica ScanStation P40/P30 documentation and software

- Leica ScanStation P40/P30 System USB Swing Card
 - <http://www.leica-geosystems.com/downloads>
 - http://www.leica-geosystems.com/en/HDS-Laser-Scanners-SW_5570.htm
 - <https://myworld.leica-geosystems.com>
-

Table of Contents

In this manual	Chapter	Page
	1 Description of the System	10
	1.1 Packing / Unpacking	10
	2 Setting Up the Instrument	12
	2.1 General Information	12
	2.2 Scanner Setup on Tripod	13
	2.3 Setup Over a Benchmark with the Internal Laser Plummet	15
	2.4 Instrument Height	18
	3 Description of the User Interface	20
	3.1 Front Side	20
	3.2 Display	21
	3.3 Status Bar	23
	3.4 Operating Principles	31
	4 Switching the System On/Off	34
	5 Remote Control	36
	6 Main Menu	40

7	Scanning	46
7.1	Scanning\Scan Begin	46
7.2	Scanning\Setup	49
7.2.1	Scanning\Setup\Quick Orientation	50
7.2.2	Scanning\Setup\Set Azimuth	52
7.2.3	Scanning\Setup\Known Backsight	62
7.2.4	Scanning\Setup\Resection	72
7.2.5	Scanning\Setup\Auto Resection	85
7.2.6	Scanning\Setup\Setup Configuration	97
7.2.7	Scanning\Setup\Station ID Configuration	104
7.2.8	Scanning\Setup\Scale Factor	107
7.3	Scanning\Scan Parameters	112
7.3.1	Scanning\Scan Parameters\Field of View	114
7.3.2	Scanning\Scan Parameters\Resolution	127
7.3.3	Scanning\Scan Parameters\Image Control\Internal Camera	135
7.3.4	Scanning\Scan Parameters\Image Control\External Camera	143
7.3.5	Scanning\Scan Parameters\Filter	155
7.3.6	Scanning\Detail Scan Parameters	158
7.3.7	Scanning\Scan Parameters\...\Target Definition	163
8	Traverse	182
8.1	Traverse Begin	183
8.2	Traverse Configuration	186
8.3	Traverse Management	191

8.3.1	New Traverse	194
8.3.2	Edit Traverse	196
8.3.3	Delete Traverse	198
8.3.4	Traverse Data	200
8.4	Starting a Traverse	204
8.5	Traverse Foresight	210
8.6	Scanning and Imaging from a Traverse Station	218
8.7	Traverse Backsight	220
8.8	Traverse Results	229
8.9	Adjustment Results	235
9	Manage	242
<hr/>		
9.1	Manage\Projects	244
9.1.1	Manage\Projects\New Project	247
9.1.2	Manage\Projects>Edit Project	251
9.1.3	Manage\Projects>Delete Project	253
9.1.4	Manage\Projects\Data	255
9.1.5	Manage\Projects\Transfer Project	267
9.2	Manage\Targets	268
9.2.1	Manage\Targets\New Target	271
9.2.2	Manage\Targets>Edit Target	273
9.2.3	Manage\Targets>Delete Target	275
9.3	Manage\Control Points	277
9.3.1	Manage\Control Points\Import Control Points	280

9.3.2	Manage\Control Points\Data	285
9.3.3	Manage\Control Points\Data\New Control Point	287
9.3.4	Manage\Control Points\Data>Edit Control Point	289
9.3.5	Manage\Control Points\Data>Delete Control Point	291
9.3.6	Manage\Control Points\Data\Import Control Points	292
9.3.7	Manage\Control Points\Data>Delete All Control Points	292
10	Status	294

10.1	Status\Battery & Memory	299
10.2	Status\System Information	303
10.3	Status\Level & Laser Plummet	309
10.4	Status\WiFi	316
11	Configuration	320

11.1	Configuration\Units & Formats	322
11.2	Configuration\Date & Time	325
11.3	Configuration\Settings	328
11.4	Configuration\Language	334
11.5	Configuration\Wake-Up Session	336
12	Tools	340

12.1	Tools\Format	343
12.2	Tools\Transfer	345
12.3	Tools\License	355

12.4 Tools\Screen Calibration	359
12.5 Check & Adjust	361

1 Description of the System

1.1 Packing / Unpacking

Unpacking

When in its transport container, the ScanStation P40/P30 can sit in either a face-up or face-down position.

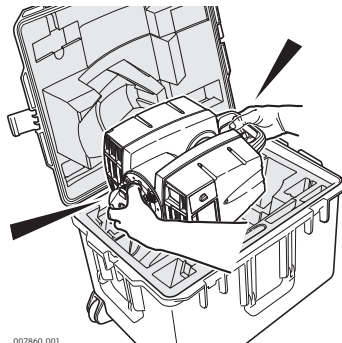

To take the instrument out of its container, grasp the handle and the base of the instrument, and lift. Use caution due to the weight of the instrument (12 kg).



Pack the instrument the same way it is delivered.

2 Setting Up the Instrument

2.1 General Information

Use the tripod

The instrument should always be set up on its tripod. Using the tripod specified for the scanning system guarantees maximum stability during scanning operations.



Always set up the instrument on its tripod. Do not set up the instrument directly on the ground for scanning operations.



It is always recommended to shield the instrument from direct sunlight and avoid uneven temperatures around the instrument.

2.2

Scanner Setup on Tripod

ScanStation P40/P30 setup step-by-step

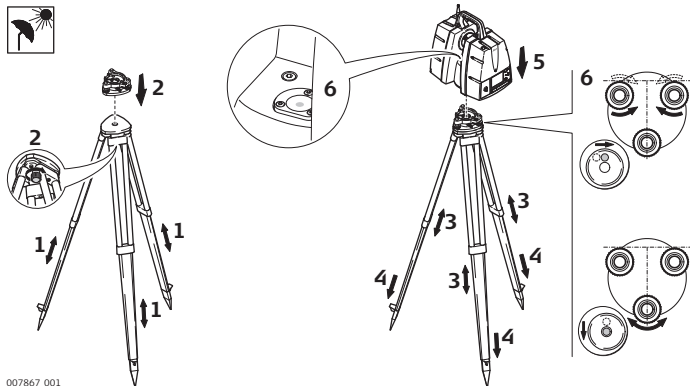

Shield the instrument from direct sunlight and avoid uneven temperatures around the instrument.

1. Extend the tripod legs to allow for a comfortable working posture. Tighten the screws at the bottom of the legs.
2. Place the tribrach on the tripod and secure it with the central fixing screw.

3. Set up the tripod so that the tripod plate is as horizontal as possible.
 4. Push the tripod legs firmly into the ground.
 5. Place the instrument on the tribrach and secure it with the locking knob of the tribrach.
 6. Level up the instrument using the instrument's circular level. Turn two of the foot screws together in opposite directions. The index finger of your right hand indicates the direction in which the bubble should move. Now use the third foot screw to centre the bubble.
-

2.3 Setup Over a Benchmark with the Internal Laser Plummet

Description

This topic describes an instrument setup over a marked ground point using the laser plummet. Geo-referencing of the Leica ScanStation P40/P30 is established by setting up over a known or assumed control point, with optional reference target measurement to set the azimuth direction, and establishing a local or global coordinate system.

The Leica ScanStation P40/P30 allows you to traverse, resect or free-station. Known azimuth or known backsight measurements can be observed.



It is always possible to set up the instrument without the need for a marked ground point.



With the dual-axis compensator enabled, the data scanned with ScanStation P40/P30 is corrected automatically.



About the plummet:

- The laser plummet described in this topic is built into the vertical axis of the instrument. It projects a red spot onto the ground, making it much easier to centre the instrument.
 - The laser plummet cannot be used in conjunction with a tribrach equipped with an optical plummet.
-

Setup with Laser Plummet step-by- step

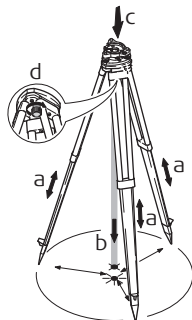

007868_001

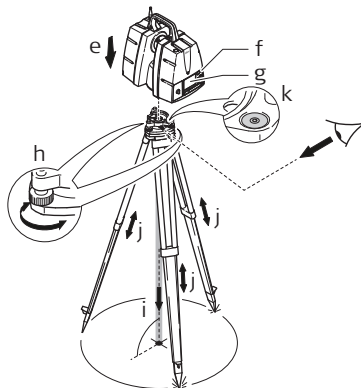

Shield the instrument from direct sunlight and avoid uneven temperatures around the instrument.

1. Extend the tripod legs to allow for a comfortable working posture (**a**). Position the tripod approximately over the marked ground point, centring it as well as possible (**b**).
2. Place the tribrach on the tripod (**c**) and secure it with the central fixing screw (**d**).

3. Place the instrument on the tribrach (**e**) and secure it with the tribrach's locking knob.
 4. Turn on the instrument by pressing the ON/OFF button (**f**). Go to **Status, Level & Laser Plummet, Plummet** and activate the laser plummet (**g**).
 5. Move the tripod legs (**a**) and use the tribrach footscrews (**h**) to centre the plummet (**i**) over the ground point.
 6. Adjust the tripod legs (**j**) to level the circular level (**k**).
 7. By using the electronic level (**Status, Level & Laser Plummet, Level**) turn the tribrach footscrews (**h**) to precisely level the instrument.
 8. Centre the instrument precisely over the ground point (**i**) by shifting the tribrach on the tripod plate.
 9. Repeat steps 7. and 8. until the required accuracy is achieved.
-

2.4 Instrument Height

ScanStation P40/P30 height setup step-by-step

To get an accurate height measurement use the GHM008 instrument height meter in conjunction with the GHT196 distance holder. Both are included with the scanner.

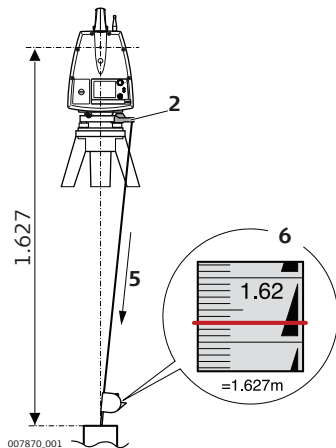

1. Place tripod centrally over the ground point, level instrument.
2. Click GHT196 distance holder to tribrach. It must "snap" onto the cover over an adjusting screw.
3. Unfold measuring tongue, pull out tape measure a little.
4. Insert GHM008 instrument height meter in the distance holder and attach.
5. Swivel measure in the direction of the ground point, pull out until the tip of the measuring tongue touches the point on the ground, keep under tension and do not allow to sag, clamp if necessary.
6. Read height of the instrument (ground - tilt axis) in the reading window at the red marking (in the example 1.627 m).



- For detailed information about the GHM008 instrument height meter and GHT196 distance holder refer to the GHM008/GHT196 user manual which is delivered with these items.
 - The tilt axis height of the ScanStation P40/P30 is 250 mm. Take care to use the GHM008 which has a special scale to measure the height of instruments with a tilt axis height of 250 mm. Do not use a tape with any other scale.
 - Alternatively the instrument height can be measured with a common, 1:1 scaled measuring tape from the point on the ground to the little notch under the red Leica logo at both side covers of the scanner. This distance will then be from the ground point to the tilt axis.
-

3 Description of the User Interface

3.1 Front Side

Overview

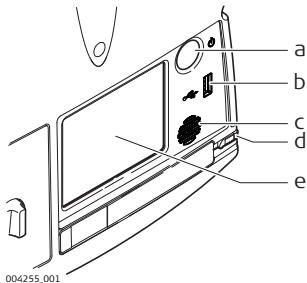

- a) ON/OFF button
- b) USB socket
- c) Loudspeaker
- d) Stylus
- e) Touch screen user interface

3.2

Display

Overview

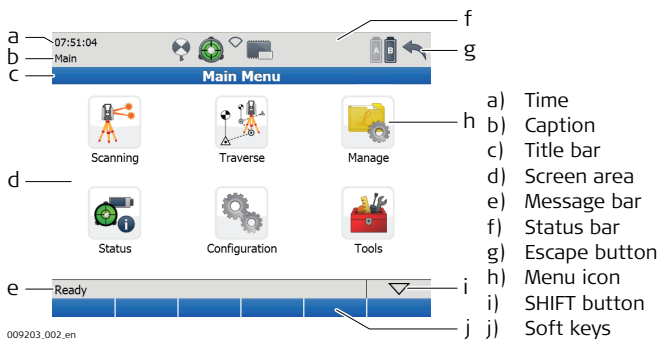

009203_002_en

Element	Description
Time	The current local time is shown.
Caption	Shows location in menu system.
Title bar	Shows name of current screen.

Element	Description
Screen area	Working area of the screen.
Message bar	Shows messages.
Status bar	Shows current status information for the instrument.
Escape button	Returns to the previous screen.
Menu icon	Selecting menu icons opens submenus.
SHIFT button	Displays the second level of soft keys.
Soft keys	Commands can be executed with the soft keys.

3.3

Status Bar

Overview



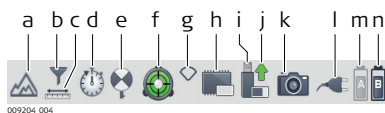

The icons in the status bar display the current status information of the instrument. Clicking a status icon gives direct access to a detailed status description.

















- a) Range mode
- b) Range filter
- c) Scale factor
- d) Wake up mode
- e) Active target type
- f) Dual-axis compensator
- g) WiFi status
- h) Internal hard disc
- i) External memory
- j) Status of external memory
- k) External camera
- l) External battery / AC power supply
- m) Internal battery **A**
- n) Internal battery **B**





















- **Internal battery A** indicates the status of the battery in compartment **A** which is located at the same side cover as the touch screen.
- **Internal battery B** indicates the status of the battery in compartment **B** at the opposite side cover without a screen.
- First the battery with the lower remaining power is discharged. Once the first battery has been discharged, the instrument automatically switches to the second battery.







Icon	Description
Range mode 	Range mode enabled
Range filter 	Range filter enabled
Scale factor 	Scale factor enabled
Wake Up mode 	Wake Up mode enabled







Icon	Description
Active target type	 Leica B/W 4.5" target
	 HDS black/white target 6"
	 HDS black/white target 3"
	 HDS sphere target
	 User defined target of type Leica B/W 4.5"
	 User defined target of type HDS black/white 6"
	 User defined target of type HDS black/white 3"
	 User defined target of type HDS sphere

Icon	Description
Dual-axis compensator	 On and levelled
	 Off
	 On but out of range
WiFi	 Onboard WiFi adapter on and connected.
	 Onboard WiFi adapter off.
	 Onboard WiFi adapter on.
External camera	 External camera connected and selected for image acquisition.

Icon	Description
Internal hard disc	 Empty
	 13% memory used
	 25% memory used
	 38% memory used
	 50% memory used
	 63% memory used
	 75% memory used
	 88% memory used
	 Full
	Status of external memory
 Do not remove	

Icon	Description
External memory 	Empty
	17% memory used
	33% memory used
	50% memory used
	67% memory used
	83% memory used
	Full
External battery / AC power supply 	External battery connected
	AC power supply connected

Icon	Description
Internal battery A/B	Symbols for the currently used battery:
	 Empty
	 20% capacity
	 40% capacity
	 60% capacity
	 80% capacity
	 Full

Icon	Description
Symbols for the currently unused battery:	
	Empty
	20% capacity
	40% capacity
	60% capacity
	80% capacity
	Full

3.4

Keyboards on touchscreen

Operating Principles

The system offers two different virtual keyboard layouts for user input:

- When an **alphanumeric input field** is selected with the stylus, the keyboard will appear in alphanumeric layout. This layout offers letters, numbers and special characters.
 - When an **numeric input field** is selected with the stylus, the keyboard will appear in numeric layout. This layout offers numbers and some special characters.
-

Keyboard layouts Alphanumeric layout:

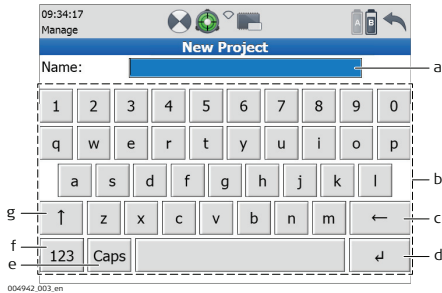

Numeric layout:

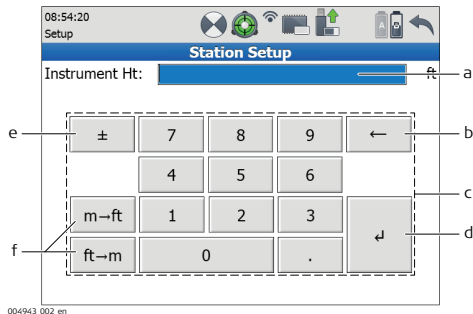

- a) Input field
- b) Backspace
- c) Numeric keypad
- d) Enter
- e) Toggle between positive and negative number
- f) Unit calculator (optional when distance units **ft** or **fi** are selected)

4

Switching the System On/Off

Switch on procedure

1. Set up the instrument as desired. Refer to chapter "2 Setting Up the Instrument" for more information.
 2. Press and hold the ON/OFF button for 2 seconds until a beep is audible.
 3. The instrument starts with several subsequent beeps and a short melody.
 4. The **Leica Geosystems** welcome screen starts.
 5. Wait until the **Main Menu** appears on the display.
-

Switch off procedures

Shutdown via Main Menu:

1. From the current menu return to the **Main Menu**.
2. In the **Main Menu** press the  button.
3. In the popup window confirm the question **Do you want to shutdown?** with **Yes**.
4. Wait for the scanner to shut down.

Shutdown via On/Off button:

1. Press and hold the **On/Off button** for 1 second until a **single beep** is audible.
2. Wait for the scanner to shut down.

In case of a system crash (forced shutdown):

1. Press and hold the **On/Off button** for 6 seconds until a **double beep** is audible.
 2. Wait for the scanner to shut down.
-

5

Remote Control

Overview

The ScanStation P40/P30 can be controlled remotely by a Leica handheld controller (CS10, CS15, CS20 or CS35) or by external devices (Apple iOS or Android driven) via WiFi communication.

Installation of the ScanStation Pxx Remote Control App on the Leica Viva Controller

The following hardware is needed:

- Viva Controller (CS10 or CS15) equipped with a WiFi adapter. Check the sticker **This device contains...** in the battery compartment of the Viva Controller: In case a WLAN module is listed, the controller is equipped with a WiFi adapter.
1. Copy the installation file **Pxx_RemoteControl.CAB** onto a USB memory device.
 2. Switch on the Viva Controller and connect the USB memory device to the controller.
 3. In case SmartWorx Viva app is running, close this app by pressing **Fn -> Exit**.
 4. Double-click **My Device** and navigate to the USB memory device.
 5. Double-click the file **Pxx_RemoteControl.CAB**.
 6. Confirm the suggested installation folder **Program Files** by pressing **OK** within the **Install Leica Geosystems AG Pxx ...** dialog.
 7. The app will be installed. A start-up menu folder as well as a desktop icon will be created.
 8. Disconnect the USB memory device.
-

Enable the WiFi adapter of your Viva Controller

1. Go to **Start** -> **Settings** -> **Control Panel**.
 2. Double-click on **Network and Dial-up Connections**.
 3. Select the icon of the WiFi device (e. g. **NXPWLAN1**) and press **File**. If the menu lists **Disable**, the WiFi device is already enabled. In this case leave the control panel without any changes. If the menu lists **Enable**, press **Enable** and leave the control panel.
 4. Close the control panel.
-

ScanStation P40/P30 Remote Control

1. Switch on the ScanStation P40/P30 and wait for the boot process to finish.
2. Select **Status** to get to the **Status Menu**.
3. In the **Status Menu** select **Connections** to open the **WiFi** menu.
4. In the **WiFi** menu set:
 - WiFi Operation = Enabled
 - WiFi Connection = Ad-hoc mode
5. Start the ScanStation Pxx Remote Control app on your Viva Controller by double-clicking the desktop icon.
6. Within the ScanStation Pxx Remote Control dialog press **Find scanner** and wait for your ScanStation P40/P30 to be listed within the list of available scanners.
7. As soon as your ScanStation P40/P30 is listed, select it and press **Connect**.
8. Wait until the ScanStation P40/P30 onboard control is displayed on your Viva Controller.

9. Close the ScanStation P40/P30 Remote Control window as well as the ScanStation P40/P30 Remote Control dialog by pressing the  button in the respective dialog.
-



The USB port of the Viva Controller will not replace the USB port of the ScanStation P40/P30 while you are connected to the scanner. In order to download scanning projects, upload control point files or system files you always have to use the USB port of the ScanStation P40/P30.



Since the Viva Controller CS10 has a screen in upright format the ScanStation Pxx Remote Control app offers the option to rotate the onboard control by 90° on the controller's screen. In order to activate the 90°-rotation, select **Rotate screen**. This option is not available on the Viva Controller CS15.



For details about the CS10/CS15 controllers refer to the CS10/CS15 user manual.



For details on how to control the ScanStation P40/P30 remotely via other devices (Leica CS20 or CS35, Apple iOS or Android driven) refer to the instructions provided in the HDS Laser Scanners section of Leica myWorld.

6 Main Menu



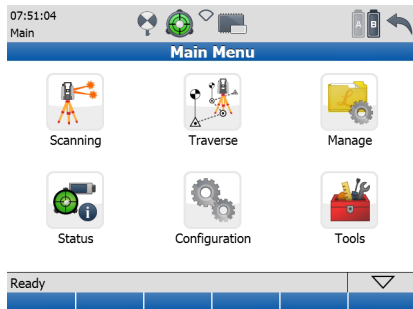

Description

The **Main Menu** will be displayed after the system boot process. **Ready** in the message bar indicates that the instrument is ready for scanning.



Main Menu screen (Advanced User Interface)



Icon	Function
	Offers access to all commands for scanner setup and operation control.

Icon		Function
Traverse		Offers access to the Traverse workflow to establish a polygon of control points for further scanning operations.
Manage		Offers access to all commands for project, target and control point management.
Status		Offers access to all commands for the scanner's status information.
Configuration		Offers access to all commands for the configuration of the system.
Tools		Offers access to all commands for disc formatting, data transfer, license management, display calibration and Check & Adjust.

Available commands:

Command		Function
Shift -> Std. UI	 	Switch to the Standard User Interface.

Main Menu screen (Standard User Interface)















Start Scan







Icon	Function
Start Scan 	Start scan and/or imaging process with settings as defined in Param .

Available commands:

Command		Function
Param		Offers access to all commands for scanner control.
Project		Offers access to all commands for project management.
Status		Offers access to all commands for the scanner's status information.
Config		Offers access to all commands for the configuration of the system.
Tools		Offers access to all commands for disc formatting, data transfer, license management, display calibration and Check & Adjust.
Shift -> Scale	 	Open the Scale Factor screen to define atmospheric and geometric corrections.
Shift -> Adv. UI	 	Switch to the Advanced User Interface.
Shift -> CamOri	 	Start camera orientation process for external camera. Deactivated when no external camera available.

Command	Function
Shift -> Std.ID  	Open the Station ID Configuration screen to define a station ID prefix which is incremented every time a scan is started from the Main Menu .

Menu independent commands

Command	Function
Escape 	Return to previous menu in menu hierarchy.
Shift -> Quit  	Return to main menu.
Page 	Switch between pages in a menu.

7 Scanning

Access

Select **Main Menu, Scanning**  .

Description

In the **Scanning** menu all commands for the scanner setup and operation control are available.

7.1 Scanning\Scan Begin

Access

Select **Main Menu, Scanning**  .

Description

Scan data is stored on the ScanStation P40/P30 by projects which contain stations for each scanner position. In the **Scan Begin** screen a new project can be created or an existing project can be selected. For a chosen project a new station can be defined by various setup methods (Standard, Quick Orientation, Set Azimuth, Known Back-sight, Resection or Auto Resection) or an existing one can be used to continue.

Scan Begin screen



Project:

ProjectName ▼ ⚙



Field	Description
Project	Shows the current project. Click the name field to open a list of available projects. Click the ⚙ icon to open the Manage, Projects screen for selecting another project, adding a new project, editing or deleting an existing project, and displaying project details.

Available commands:

Command	Function
Cont	Continue with the current project. Opens the Current Station Information window.
Setup	Opens the Station Setup screen for station setup via Quick Orientation, Set Azimuth, Known Backsight, Resection or Auto Resection).
ChkBS	Open Check Backsight screen to define a known backsight target for current setup control.
Shift -> New Stn	Create a new station. (Only active when the current setup method is not a Standard Setup .)
Shift -> Scale	Open the Scale Factor screen to define atmospheric and geometric corrections.
Shift -> Stn.ID	Open the Station ID Configuration screen to define Station ID Generation and set a Station ID Template .

7.2

Scanning\Setup

Access

Select **Main Menu, Scanning**  .

Description

In the **Scanning, Scan Begin** screen various methods for station setup can be chosen by the command **Setup**:

1. Standard Setup
 2. Quick Orientation
 3. Set Azimuth
 4. Known Backsight
 5. Resection (by 4 or 6 parameter transformation)
 6. Auto Resection
-

7.2.1 Scanning\Setup\Quick Orientation

Access

Select **Main Menu, Scanning**  , **Setup**.

Description

The **Quick Orientation** setup option offers scanner setup over a known control point and azimuth definition without aiming at a target.

Station Setup: Quick Orientation screen

Station Setup	
Setup Method:	Quick Orientation ▼
Ctrl Pnt Project:	myProject ▼
Station ID:	100 ▼
Instrument Ht:	1.8000 m
Azimuth:	100.000 deg

Ready				
Set	Az=0	New	PickAz	▼

Field	Description
Setup Method	Select the station setup method.
Ctrl Pnt Project	Select the project which contains the current station control point.
Station ID	Select the station ID of the current station.
Instrument Ht	Enter the instrument height (control point to tilt axis).
Azimuth	Enter the azimuth to define the orientation of the project coordinate system.

Available commands:

Command	Function
Set	Accept station setup and proceed to Scan Parameters screen.
Az=0	Set the Azimuth = 0.
New	Open the New Control Point screen to create a new control point in the selected project.
PickAz	Select azimuth direction from the video image.

7.2.2 Scanning\Setup\Set Azimuth

Access

Select **Main Menu, Scanning**  , **Setup**.

Description

The **Set Azimuth** setup option offers scanner setup over a known control point and azimuth definition by aiming at a backsight target.

Station Setup: Set Azimuth screen

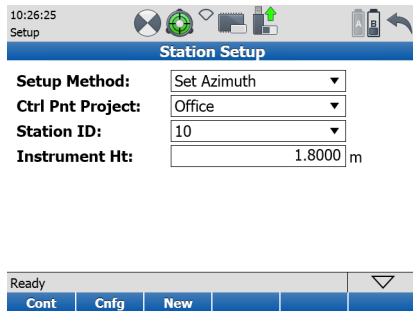

The screenshot shows the 'Station Setup' screen with the following configuration:

Station Setup	
Setup Method:	Set Azimuth
Ctrl Pnt Project:	Office
Station ID:	10
Instrument Ht:	1.8000 m

At the bottom of the screen, there is a status bar with the text 'Ready' and a navigation menu with buttons for 'Cont', 'Cnfg', 'New', and a dropdown arrow.

Field	Description
Setup Method	Select the station setup method.
Ctrl Pnt Project	Select the project which contains the current station control point.
Station ID	Select the station ID of the current station.
Instrument Ht	Enter the instrument height (control point to tilt axis).

Available commands:

Command	Function
Cont	Confirm station input and continue with DefineBacksight: Set Azimuth .
Cnfg	Opens the General tab in Setup Configuration where a reminder for the station information can be enabled/disabled and target scanning by one face or two faces can be defined.
New	Opens the New Control Point screen to create a new control point in the selected project.

Define Backsight: Set Azimuth screen, Target Def

13:46:35
Setup

Define Backsight: Set Azimuth

Target Def Target List

Backsight ID: 11

Target Type: B/W Target 6"

Target Height: 1.471 m

Azimuth: 100.000 deg

Pick Method: Video Image

Ready

Cont Az=0 PickT Page

Field	Description
Backsight ID	Enter the target ID of a new backsight target.
Target Type	Enter the target type of the selected backsight target.
Target Height	Enter the target height of the selected backsight target.
Azimuth	Enter the azimuth to define the orientation of the project coordinate system.

Field	Description
Pick Method	Select the source for target picking. With Video Image selected the PickT command opens the video camera image for target selection. With Red Laser selected the PickT command activates the red laser for target selection.

Available commands:

Command	Function
Cont	Execute backsight target scan and setup calculation. Show results in Set Azimuth Results screen.
Az=0	Set the Azimuth = 0.
PickT	Select target from the video image or by using the red laser. After selection, the target is listed on the Target List page.
Page	Switch to the Target List page.

Define Backsight: Set Azimuth screen, Target List

14:31:40
Setup



Define Backsight: Set Azimuth

Target Def Target List

Target ID	Type	Height	State
11	B/W Target 6"	1.4710 m	-----

Ready

Cont	Az=0	ScanT	Page
------	------	-------	------

Field	Description
Target ID	Shows the target ID of a new backsight target after PickT was executed.
Type	Shows the target type of the selected backsight target after PickT was executed.
Height	Shows the target height of the selected backsight target after PickT was executed.

Field	Description
State	Status of scanned target. OK indicates a successful acquisition of the target centre. A bad target centre acquisition is marked as BAD .

Available commands:

Command	Function
Cont	Start backsight target scan to selected target and setup calculation. Show results in Set Azimuth Results screen.
Az=0	Set the Azimuth = 0.
ScanT	Scan selected target and return to the Target List .
Page	Switch to the Target Def page.
Shift -> View	View point cloud of selected target scan.

Set Azimuth Results screen, Stn & Tgt

10:35:00
Setup

Set Azimuth Results

Stn & Tgt | Tgt Coords

Station ID: 10
Instrument Ht: 1.8000 m
Backsight ID: 11
Target Height: 1.4710 m
Target Type: B/W Target 6"
Horiz Dist: 2.0778 m

Ready

Set | Info | View | Page

Field	Description
Station ID	Station ID of current station.
Instrument Ht	Instrument height as entered by the user.
Backsight ID	Target ID of the selected backsight target.
Target Height	Target height as entered by the user.
Target Type	Target type of the selected backsight target.
Horiz Dist	Horizontal distance between station and backsight target.

Available commands:

Command	Function
Set	Accept the setup results for this station and proceed to Scan Parameters screen.
Info	Show the target information of the selected target.
View	View point cloud of selected backsight target scan.
Page	Switch to the Tgt Coords page.
Shift -> Re-Pick	Open the video viewer to pick and scan the target again.
Shift -> Redo	Repeat backsight target scan of selected target and setup calculation.

Set Azimuth Results screen, Tgt Coords

10:39:17
Setup

Set Azimuth Results

Stn & Tgt | Tgt Coords

Backsight ID: 11
Northing: 0.8725 m
Easting: 2.7141 m
Height: -1.0763 m

Ready

Set	Info	View			Page
-----	------	------	--	--	------

Field	Description
Backsight ID	Target ID of the selected backsight target.
Northing	Northing of the selected backsight target calculated from scanned target data and user defined azimuth.
Easting	Easting of the selected backsight target calculated from scanned target data and user defined azimuth.
Height	Height of the selected backsight target calculated from scanned target data.

Available commands:

Command	Function
Set	Accept the setup results for this station and proceed to Scan Parameters screen.
Info	Show the target information of the selected target.
View	View point cloud of selected backsight target scan.
Page	Switch to the Stn & Tgt page.

7.2.3 Scanning\Setup\Known Backsight

Access

Select **Main Menu, Scanning**  , **Setup**.

Description

The **Known Backsight** setup option offers scanner setup over a known control point and scanner orientation by aiming at a known backsight target.

Station Setup: Known Backsight screen

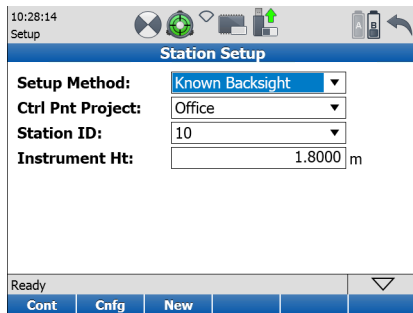

10:28:14	Setup			
Station Setup				
Setup Method:	Known Backsight			
Ctrl Pnt Project:	Office			
Station ID:	10			
Instrument Ht:	1.8000 m			
Ready	▽			
Cont	Cnfg	New		

Field	Description
Setup Method	Select the station setup method.
Ctrl Pnt Project	Select the project which contains the current station control point.
Station ID	Select the station ID of the current station. The preset StationID is the last measured target in the project.
Instrument Ht	Enter the instrument height (control point to tilt axis). The preset instrument height is the height of the last measured target in the project.

Available commands:

Command	Function
Cont	Confirm station input and continue with Define Backsight: Known Backsight .
Cnfg	Opens the Setup Configuration for the known backsight method.
New	Opens the New Control Point screen to create a new control point.

Station Setup: Known Backsight screen, Target Def

13:50:13
Setup

Define Backsight: Known Backsight

Target Def Target List

Ctrl Pnt Project: Control Points ▼

Backsight ID: 11 ▼

Target Type: B/W Target 6" ▼

Target Height: 1.471 m

Pick Method: Video Image ▼

Ready

Cont New PickT Page

Field	Description
Ctrl Pt Project	Select the control point project which contains the backsight point.
Backsight ID	Enter the ID of the backsight point. The preset BackSight ID is the ID of the previous station.
Target Type	Select the type of the backsight target.

Field	Description
Target Height	Enter the height of the backsight target. The preset target height is the height of the previous station.
Pick Method	Select the source for target picking. With Video Image selected the PickT command opens the video camera image for target selection. With Red Laser selected the PickT command activates the red laser for target selection.

Available commands:

Command	Function
Cont	Execute backsight target scan and setup calculation. Show results in Known Backsight Results screen.
New	Opens the New Control Point screen.
PickT	Select target from the video image or by using the red laser. After selection, the target is listed on the Target List page.
Page	Switch to the Target List page.

Station Setup: Known Backsight, Target List

14:34:59
Setup

Define Backsight: Known Backsight

Target Def Target List

Target ID	Type	Height	State
11	B/W Target 6"	1.4710 m	-----

Ready

Cont	New		ScanT	Page
------	-----	--	-------	------

Field	Description
Target ID	Shows the point ID of the backsight point after PickT was executed.
Type	Shows the target type on the backsight point after PickT was executed.
Height	Shows the target height of the selected backsight target after PickT was executed.

Field	Description
State	Status of scanned target. OK indicates a successful acquisition of the target centre. A bad target centre acquisition is marked as BAD .

Available commands:

Command	Function
Cont	Execute backsight target scan and setup calculation. Show results in Known Backsight Results screen.
New	Open the New Control Point menu to enter a new control point.
ScanT	Scan selected target and return to the Target List .
Page	Switch to the Target Def page.
Shift -> View	View point cloud of selected target scan.

**Station Setup:
Known Backsight
Results screen,
Stn & Tgt**

10:52:44
Setup

Known Backsight Results

Stn & Tgt

Station ID: 10
Instrument Ht: 1.8000 m
Backsight ID: 11
Target Height: 1.4710 m
Target Type: B/W Target 6"
Horiz Dist: 2.0778 m

Ready

Field	Description
Station ID	Station ID of current station.
Instrument Ht	Instrument height as entered by the user.
Backsight ID	Point ID of the backsight point.
Target Height	Target height as entered by the user.
Target Type	Target type on the backsight point.
Horiz Dist	Horizontal distance between station and backsight point.

Available commands:

Command	Function
Set	Accept the setup results for this station and proceed to Scan Parameters screen.
Info	Show the target information of the selected target.
View	View point cloud of backsight target scan.
Page	Switch to the Delta page.
Shift -> Re-Pick	Open the video viewer to pick and scan the target again.
Shift -> Redo	Rerun backsight target scan and setup calculation.

Station Setup:
Known Backsight
Results screen,
Delta

10:55:49
Setup

Known Backsight Results

Stn & Tgt Delta

Backsight ID: 11
 Δ Northing: 0.0000 m
 Δ Easting: 0.0001 m
 Δ Height: -0.0001 m
 Δ Horiz Dist: 0.0001 m

Ready

Set Info View Page

Field	Description
Backsight ID	Point ID of the backsight point.
ΔNorthing	Difference in Northing between calculated and measured coordinate.
ΔEasting	Difference in Easting between calculated and measured coordinate.
ΔHeight	Difference in Height between calculated and measured coordinate.

Field	Description
ΔHoriz Dist	Difference in Horizontal Distance between calculated and measured distance.

Available commands:

Command	Function
Set	Accept results from Known Backsight station setup and proceed to Scan Parameters screen.
Info	Show the target information of the selected target.
View	View point cloud of backsight target scan.
Page	Switch to the Stn & Tgt page.

7.2.4 Scanning\Setup\Resection

Access





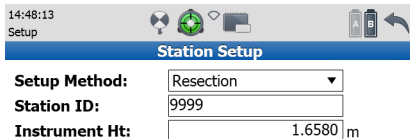

Select **Main Menu, Scanning**  , **Setup**.

Description

The **Resection** setup option offers scanner setup over an unknown station and station coordinate calculation by aiming at known target positions.

Station Setup: Resection screen



14:48:13							
Setup	Station Setup						
Setup Method:	Resection						▼
Station ID:	9999						
Instrument Ht:	1.6580						m



Ready					▼
Cont	Cnfg		Stn. ID		

Field	Description
Setup Method	Select the station setup method.
Station ID	Enter the station ID of the current station.
Instrument Ht	Enter the instrument height (control point to tilt axis).

Available commands:

Command	Function
Cont	Confirm station input and continue with Define Resection Targets .
Cnfg	Opens the Setup Configuration for the resection method.
Stn. ID	Open the Station ID Configuration screen to define Station ID Template.

Define Resection Targets screen, Target Def

14:39:23
Setup

Define Resection Targets

Target Def | Target List

Ctrl Pnt Project: office coordinates ▼

Target ID: 106 ▼

Target Type: B/W Target 6" ▼

Target Height: 0.0000 m

Pick Method: Video Image ▼

No of Targets: 3

Ready

Calc 4P | Calc 6P | | | PickT | Page

Field	Description
Ctrl Pnt Project	Select the control point project which contains the target coordinates.
Target ID	Enter the target ID of a known control point target.
Target Type	Enter the target type of the selected control point target.
Target Height	Enter the target height of the selected control point target.

Field	Description
Pick Method	Select the source for target picking. With Video Image selected the PickT command opens the video camera image for target selection. With Red Laser selected the PickT command activates the red laser for target selection.
No of Targets	Number of picked targets to be scanned.

Available commands:

Command	Function
Calc 4P	Start target scan to selected targets and setup calculation by a 4 parameters transformation: 3 translations and 1 rotation around z axis. Requires at least 2 targets. Show results in Resection Results screen.
Calc 6P	Start target scan to selected targets and setup calculation by a 6 parameters transformation: 3 translations and 3 rotations. Requires at least 3 targets. Show results in Resection Results screen.

Command	Function
PickT / Add	Select target centre from the video camera image or by using the red laser. After selection, the target is listed on the Target List page as a candidate for target acquisition.  When an orientation has already been computed then the additional target can be added from a list by Add and aimed automatically without any target picking.
Page	Switch to the Target List page.

Define Resection Targets screen, Target List

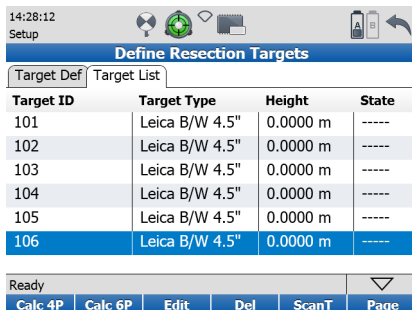

Target ID	Target Type	Height	State
101	Leica B/W 4.5"	0.0000 m	-----
102	Leica B/W 4.5"	0.0000 m	-----
103	Leica B/W 4.5"	0.0000 m	-----
104	Leica B/W 4.5"	0.0000 m	-----
105	Leica B/W 4.5"	0.0000 m	-----
106	Leica B/W 4.5"	0.0000 m	-----

Ready

Calc 4P	Calc 6P	Edit	Del	ScanT	Page
---------	---------	------	-----	-------	------

Field	Description
Target ID	Shows the target ID of a new target after PickT was executed.
Type	Shows the target type of the selected target after PickT was executed.
Height	Shows the target height of the selected target after PickT was executed.
State	Status of scanned target. OK indicates a successful acquisition of the target centre. A bad target centre acquisition is marked as BAD .

Available commands:

Command	Function
Calc 4P	Start target scan to selected targets and setup calculation by a 4 parameters transformation: 3 translations and 1 rotation around z axis. Requires at least 2 targets. Show results in Resection Results screen.

Command	Function
Calc 6P	Start target scan to selected targets and setup calculation by a 6 parameters transformation: 3 translations and 3 rotations. Requires at least 3 targets. Show results in Resection Results screen.
Edit	Open the Edit Target menu to edit the selected target.
Del	Delete selected target from the target list.
ScanT	Scan selected target and return to the Target List .
Page	Switch to the Target Def page.

Resection Results screen, Stn Coords

14:59:28
Setup

Resection Results

Stn Coords | Sigma | Target List | Plot

Station ID: 9998
Instrument Ht: 1.6580 m
No of Targets: 6
Northing: 1.8516 m
Easting: 0.9558 m
Height: -1.6940 m

Ready

Set | | | | Page

Field	Description
Station ID	Station ID of current station.
Instrument Ht	Instrument height as entered by the user.
No of Targets	Number of targets used for resection calculation.
Northing	Northing of current station calculated by resection setup.
Easting	Easting of current station calculated by resection setup.
Height	Height of current station calculated by resection setup.

Available commands:

Command	Function
Set	Accept the setup results for this station and proceed to Scan Parameters screen.
Page	Switch to the Sigma page.

Resection Results
screen, Sigma

14:40:46
Setup

Resection Results

Stn Coords Sigma Target List Plot

Station ID: 9999
 σ Northing: 0.0011 m
 σ Easting: 0.0024 m
 σ Height: 0.0014 m
 σ H_Z Orient: 53"

Ready

Set Orient Page

Field	Description
Station ID	Station ID of current station.
σNorthing	Standard deviation of station northing.
σEasting	Standard deviation of station easting.
σHeight	Standard deviation of station height.
σHz Orient	Standard deviation of horizontal orientation.

Available commands:

Command	Function
Set	Accept the setup results for this station and proceed to Scan Parameters screen.
Orient / E,N,H	For a 6 parameter resection toggle between display of standard deviations for the station coordinates and the 3 rotation angles.
Page	Switch to the Target List page.

Resection Results
screen, Target List

14:42:56 Setup					
Resection Results					
Stn Coords	Sigma	Target List	Plot		
Target ID	dN	dE	dH	Use	
101	0.0015	0.0003	0.0005	Yes	
102	0.0010	0.0013	-0.0005	No	
103	0.0014	0.0033	-0.0005	Yes	
104	-0.0011	-0.0039	0.0001	Yes	
105				No	
106	-0.0028	0.0030	-0.0001	Yes	
Ready					▽
Set	Add	View	Use	Page	

Field	Description
Target ID	Target ID of scanned target.
dN, dE, dH	Target residuals dN, dE, dH.
Use	Target status for resection calculation (Yes = used, No = not used).

Available commands:

Command	Function
Set	Accept the setup results for this station and proceed to Scan Parameters screen.
Add	Switch to Define Resection Targets and define additional targets for resection.  When an orientation has already been computed then the additional target can be aimed automatically and no target picking is required.
View	View point cloud of selected target scan.
Use	Change the target status in the Use field from Yes to No .
Page	Switch to the Plot page.
Shift -> Re-Pick	Open the video viewer to pick and scan the target again.
Shift -> Redo	Repeat target scan to selected target and setup calculation.

Resection Results screen, Plot

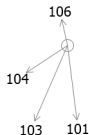

Field	Description
Set	Accept the setup results for this station and proceed to Scan Parameters screen.
Page	Switch to the Stn Coords page.

7.2.5

Scanning\Setup\Auto Resection

Access

Select **Main Menu**, **Scanning** , **Setup**.

Description

The **Auto Resection** setup option offers scanner setup over an unknown station and station coordinate calculation by aiming at known target positions without using target IDs.

Station Setup: Auto Resection screen

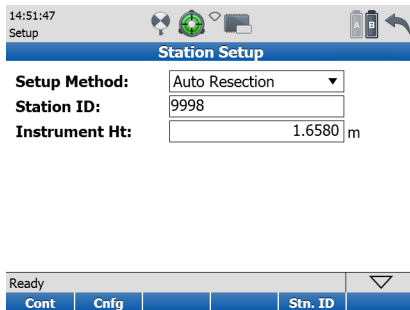

14:51:47
Setup

Station Setup

Setup Method: Auto Resection

Station ID: 9998

Instrument Ht: 1.6580 m

Ready

Cont Cnfg Stn. ID

Field	Description
Setup Method	Choose Auto Resection as setup method.
Station ID	Enter the station ID of the current station.
Instrument Ht	Enter the instrument height (control point to tilt axis).

Available commands:

Command	Function
Cont	Confirm station input and continue with Define Resection Targets .
Cnfg	Opens the Setup Configuration for the resection method.
Stn.ID	Open the Station ID Configuration screen to define Station ID Template.

Define Resection Targets screen, Target Def

14:39:23
Setup

Define Resection Targets

Target Def Target List

Ctrl Pnt Project: office coordinates ▼

Target Type: B/W Target 6" ▼

Target Height: 0.0000 m

Pick Method: Video Image ▼

No of Targets: 3

Ready

Calc 4P Calc 6P PickT Page

Field	Description
Ctrl Pt Project	Select the control point project which contains the target coordinates.
Target Height	Enter the target height of the selected control point target.
Target Type	Enter the target type of the selected control point target.

Field	Description
Pick Method	Select the source for target picking. With Video Image selected the PickT command opens the video camera image for target selection. With Red Laser selected the PickT command activates the red laser for target selection.
No of Targets	Number of picked targets to be scanned.

Available commands:

Command	Function
Calc 4P	Start target scan to selected targets and setup calculation by a 4 parameters transformation: 3 translations and 1 rotation around z axis. Requires at least 2 targets. Show results in Resection Results screen.
Calc 6P	Start target scan to selected targets and setup calculation by a 6 parameters transformation: 3 translations and 3 rotations. Requires at least 3 targets. Show results in Resection Results screen.
PickT	Select target centre from the video camera image or by using the red laser. After selection, the target is listed on the Target List page as a candidate for target acquisition.

Command	Function
Page	Switch to the Target List page.

Define Resection Targets screen, Target_List

14:53:35
Setup

Define Resection Targets

Target Def Target List

Target ID	Target Type	Height	State
----	Leica B/W 4.5"	0.0000 m	-----
----	Leica B/W 4.5"	0.0000 m	-----
----	Leica B/W 4.5"	0.0000 m	-----
----	Leica B/W 4.5"	0.0000 m	-----
----	Leica B/W 4.5"	0.0000 m	-----
----	Leica B/W 4.5"	0.0000 m	-----

Ready

Calc 4P Calc 6P Edit Del ScanT Page

Field	Description
Target ID	Not used for Auto Resection.
Target Type	Shows the target type of the selected target after PickT was executed.

Field	Description
Height	Shows the target height of the selected target after PickT was executed.
State	Status of scanned target. OK indicates a successful acquisition of the target centre. A bad target centre acquisition is marked as BAD .

Available commands:

Command	Function
Calc 4P	Start target scan to selected targets and setup calculation by a 4 parameters transformation: 3 translations and 1 rotation around z axis. Requires at least 2 targets. Show results in Resection Results screen.
Calc 6P	Start target scan to selected targets and setup calculation by a 6 parameters transformation: 3 translations and 3 rotations. Requires at least 3 targets. Show results in Resection Results screen.
Edit	Open the Edit Target menu to edit the selected target.
Del	Delete selected target from the target list.

Command	Function
ScanT	Scan selected target and return to the Target List .
Page	Switch to the Target Def page.

Resection Results screen, Stn Coords

14:59:28
Setup

Resection Results

Stn Coords Sigma Target List Plot

Station ID: 9998
Instrument Ht: 1.6580 m
No of Targets: 6
Northing: 1.8516 m
Easting: 0.9558 m
Height: -1.6940 m

Ready

Set Page

Field	Description
Station ID	Station ID of current station.
Instrument Ht	Instrument height as entered by the user.

Field	Description
No of Targets	Number of targets used for auto resection calculation.
Northing	Northing of current station calculated by auto resection setup.
Easting	Easting of current station calculated by auto resection setup.
Height	Height of current station calculated by auto resection setup.

Available commands:

Command	Function
Set	Accept the setup results for this station and proceed to Scan Parameter screen.
Page	Switch to the Sigma page.

Resection Results screen, Sigma

15:00:17
Setup

Resection Results

Stn Coords Sigma Target List Plot

Station ID: 9998
 σ Northing: 0.0009 m
 σ Easting: 0.0019 m
 σ Height: 0.0009 m
 σ Hz Orient: 39"

Ready

Set Orient Page

Field	Description
Station ID	Station ID off current station.
σNorthing	Standard deviation of station northing.
σEasting	Standard deviation of station easting.
σHeight	Standard deviation of station height.
σHz Orient	Standard deviation of horizontal orientation.

Available commands:

Command	Function
Set	Accept the setup results for this station and proceed to Scan Parameter screen.
Orient / E,N,H	For a 6 parameter resection toggle between display of standard deviations for the station coordinates and the 3 rotation angles.
Page	Switch to the Target List page.

Resection Results
screen, Target_List

15:01:22 Setup					
Resection Results					
Stn Coords	Sigma	Target List	Plot		
Target ID ▾	dN	dE	dH	Use	
107	-0.0025	-0.0003	0.0003	Yes	
106	-0.0028	0.0001	-0.0004	Yes	
104	-0.0015	-0.0061	0.0017	No	
103	0.0009	0.0018	0.0003	Yes	
102	0.0009	-0.0001	-0.0003	Yes	
101	0.0017	-0.0009	0.0001	Yes	
Ready					▾
Set	Add	View	Use		Page

Field	Description
Target ID	Target ID of scanned target.
dN, dE, dH	Target residuals dN,dE,dH.
Use	Target status for resection calculation (Yes = used, No = not used).

Available commands:

Command	Function
Set	Accept the setup results for this station and proceed to Scan Parameter screen.
Add	Switch to Define Resection Targets and define additional targets for resection.
View	View point cloud of selected target scan.
Use	Change the target status in the Use field from Yes to No .
Page	Switch to the Plot page.
Shift -> Re-Pick	Open the video viewer to pick and scan the target again.
Shift -> Redo	Repeat target scan to selected target and setup calculation.

Resection Results screen

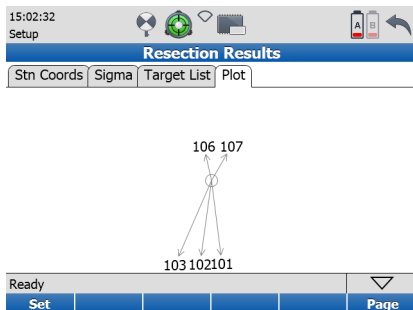

Available commands:

Command	Function
Set	Accept the setup results for this station and proceed to Scan Parameter screen.
Page	Switch to the StnCoords page.

7.2.6

Scanning\Setup\Setup Configuration

Access

Select **Main Menu, Scanning** , **Setup, Cnfg.**

Description

The **Setup Configuration** menu allows for configuring limits and specifications for the various setup methods.

General page

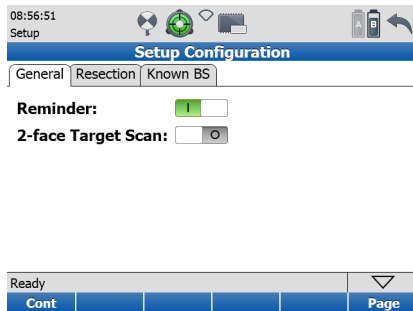

The screenshot shows the 'Setup Configuration' menu on a handheld device. At the top, the time is 08:56:51 and the word 'Setup' is displayed. Below this is a blue header bar with the text 'Setup Configuration'. Underneath the header are three tabs: 'General', 'Resection', and 'Known BS'. The 'General' tab is selected. Below the tabs, there are two toggle switches: 'Reminder' (which is turned on, indicated by a green bar) and '2-face Target Scan' (which is turned off, indicated by a grey bar). At the bottom of the screen, there is a 'Ready' status bar with a 'Cont' button and a 'Page' button with a dropdown arrow.

Field	Options	Description
Reminder	On	Enable a reminder for the station information: Current Setup Information will be displayed every time the Cont button is pressed within the Scan Begin screen.
	Off	Disable the reminder for the station information.
2-face Target Scan	On	Enable target scanning in two faces.
	Off	Scan targets in Face I only.

Available commands:

Command	Function
Cont	Confirm settings for setup configuration and continue with the Scan Begin screen.
Page	Switch to the Resection page.

Current Station Information

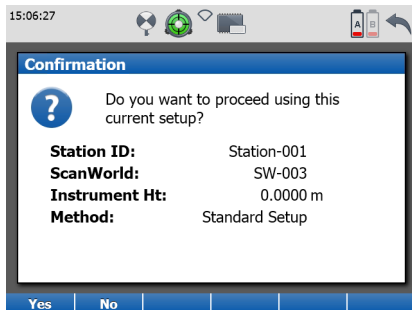

Available commands:

Command	Function
Yes	Proceed with the current setup to the Scan Parameters screen.
No	Return to the Scan Begin screen.

Resection page

09:00:40
Setup

Setup Configuration

General Resection Known BS

Accuracy Hz Ori: deg

Accuracy Pos Tgt: m

Accuracy Ht Tgt: m

Ready

Cont Page



Field	Description
Accuracy Hz Ori	Threshold for standard deviation of horizontal orientation.
Accuracy Pos Tgt	Threshold for the Easting and Northing residuals (ΔE and ΔN) of the targets used in resection.
Accuracy Ht Tgt	Threshold of height residuals (ΔH) of the targets used in resection.

Available commands:

Command	Function
Cont	Confirm settings for resection setup and continue with the Scan Begin screen.
Page	Switch to the Known BS page.

Known BS page

09:02:40
Setup

 

Setup Configuration

General | Resection | **Known BS**

Position Limit: 0.0150 m

Height Limit: 0.0150 m

Ready 

Cont **Page**

Field	Options	Description
Position Limit	On	Enable checking of horizontal coordinate difference (hz range) between existing and measured known backsight point. If defined Position Limit is exceeded, the setup can be repeated, skipped or stored.
	Off	Disable checking of horizontal coordinate difference between existing and measured known backsight point.
Height Limit	On	Enable checking of vertical difference between existing and measured known backsight point. If defined Height Limit is exceeded, the setup can be repeated, skipped or stored.
	Off	Disable checking of vertical difference between existing and measured known backsight point.

Available commands:

Command	Function
Cont	Confirm settings for known backsight setup and continue with the Scan Begin screen.
Page	Switch to the General page.

7.2.7

Scanning\Setup\Station ID Configuration

Access

Select **Main Menu, Scanning**  , **Shift->Stn.ID.**

Description

The **Station ID Configuration** menu allows for defining the naming configurations when a new station is created.

Station ID Configuration page

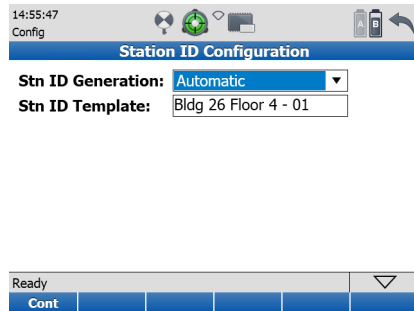

14:55:47
Config

Station ID Configuration

Stn ID Generation: Automatic

Stn ID Template: Bldg 26 Floor 4 - 01

Ready

Cont







Field	Options	Description
Stn ID Generation	Automatic	Standard setup does not ask for station ID prefix and station ID but creates new station with standard setup parameters and proceeds to the Scan Parameter screen.
	Custom	Standard setup opens the Standard Station Setup screen and asks for user-defined station ID prefix and station ID before proceeding to the Scan Parameter screen.
Station ID Template	-	Define a station ID template which is incremented by one for each standard setup.

Available commands:

Command	Function
Cont	Confirm settings for standard setup and continue with the Scan Begin screen.

Standard Station Setup

15:04:19
Setup

Standard Station Setup

Stn ID Template:

Station ID: ▼

Ready

Set

7.2.8

Scanning\Setup\Scale Factor

Access

Select **Scan Begin, Shift -> Scale** or **Traverse, Traverse Begin, Shift -> Scale** or **Scan Parameters, Shift -> Scale**.

Description

In the **Scale Factor** menu atmospheric and geometric corrections can be defined. The corrections are given as PPM (parts per million).

In the **Atmospheric PPM** page of the **Scale Factor** screen the dry air temperature and air pressure can be entered to calculate the atmospheric PPM for the atmospheric distance correction. The atmospheric correction is applied to every measured slope distance and its scale factor S can be calculated by

$$S = 1 + (\text{Atmospheric PPM} * 10^{-6}).$$

In the **Geometric PPM** page of the **Scale Factor** screen the geometric PPM for the geometric distance correction can be calculated from the instrument height above a reference datum (Height PPM) and an individual correction (User entered PPM).

The geometric correction is applied only to the horizontal distance for targets and its scale factor S can be calculated by

$$S = 1 + (\text{Geometric PPM} * 10^{-6}).$$



Once a scale factor is enabled the  icon in the status bar is visible.

Atmospheric PPM page

12:56:55
Setup

Scale Factor

Atmospheric PPM Geometric PPM

Temperature: °C

Pressure: mbar

Atmospheric PPM: 0.0000

Ready

Cont PPM=0 Page

Field	Description
Temperature	Enter the temperature in °Celsius from -20 °C to +50 °C or in °Fahrenheit from -4 °F to +122 °F.
Pressure	Enter the atmospheric pressure in Millibar from 600 mbar to 1030 mbar or in Inch of Mercury from 17.72 inHg to 30.42 inHg.
Atmospheric PPM	The Atmospheric PPM is calculated from the values in the Temperature and Pressure fields.

Available commands:

Command	Function
Cont	Accept values for Atmospheric PPM and return to previous menu.
PPM=0	Set the Atmospheric PPM to 0.0 and the parameters to default values of standard atmosphere (Temperature = 12.0 °C or 53.6 °F, Pressure = 1013.25 mbar or 29.92 inHg).
Page	Switch to the Geometric PPM page.

Geometric PPM page

13:28:25
Setup

Scale Factor

Atmospheric PPM Geometric PPM

Ground Height: --- m

Height PPM: 0.0000

User entered PPM: ---

Geometric PPM: 0.0000

Ready

Cont PPM=0 Page

Field	Description
Ground Height	Enter the height of the instrument station above reference datum (from 0 m to 4000 m).
Height PPM	<p>The Height PPM is calculated from the input in the Height PPM field with the formula:</p> $\text{Height PPM} = -H/R \cdot 10^6$ <p>With H = user entered ground height [m]; R = earth radius $6.378 \cdot 10^6$ [m]</p>

Field	Description
User entered PPM	Enter a value from -1000 to +1000.
Geometric PPM	Sum of the Height PPM and User entered PPM .

Available commands:

Command	Function
Cont	Accept values for Geometric PPM and return to previous menu.
PPM=0	Set the Height PPM and Geometric PPM to 0.0 and display "---" in the fields for Ground Height and User Entered PPM .
Page	Switch to the Atmospheric PPM page.

7.3 Scanning\Scan Parameters

Access

Select **Main Menu, Scanning** , **Scan Parameters**.

Description

Once a project and station are chosen, the **Scan Parameters** menu offers four pages for all kinds of scan and image controls: **Field of View**, **Resolution**, **Image Ctrl** and **Filter**.

Scan Parameters screen

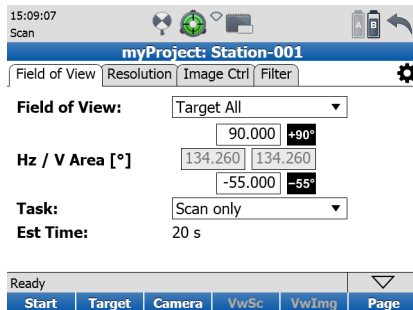

15:09:07
Scan

myProject: Station-001

Field of View Resolution Image Ctrl Filter

Field of View: Target All

90.000 +90°

H_z / V Area [°] 134.260 134.260

-55.000 -55°

Task: Scan only

Est Time: 20 s

Ready

Start Target Camera VwSc VwImg Page



In the title bar of the **Scan Parameters** screen the current project and station are constantly listed. The same information can be displayed by clicking in the message bar.

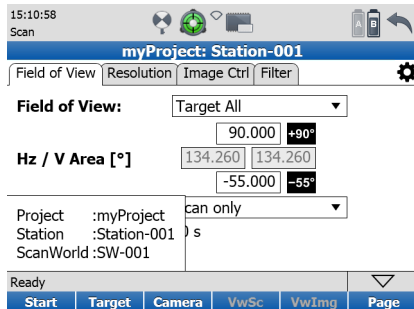

In the Scan Parameters menu the  icon offers direct access to the Configuration, Settings menu.

7.3.1 Scanning\Scan Parameters\Field of View

Access Select **Main Menu, Scanning**  , **Scan Parameters, Field of View**.

Description In the **Field of View** page of the **Scan Parameters** screen the area to be scanned can be defined by several different methods. For detailed information about the different options and commands that can be executed from this page refer to the descriptions on the following pages.

Field of View page

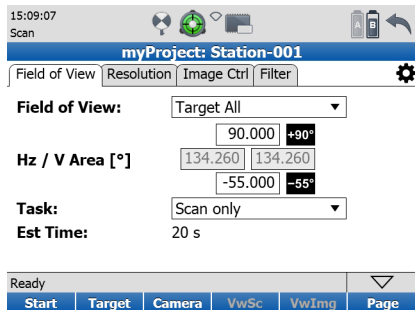

The screenshot shows the 'Field of View' page of the ScanStation software. At the top, there is a status bar with the time '15:09:07', the word 'Scan', and several icons including a scanner, a green circle with a plus sign, a Wi-Fi symbol, and a battery icon. Below this is a blue header bar with the text 'myProject: Station-001'. The main area contains several controls: a 'Field of View' dropdown menu set to 'Target All', a 'Resolution' input field with '90.000' and a '+90°' button, a 'Hz / V Area [°]' section with two input fields containing '134.260' and a '-55.000' button, a 'Task' dropdown menu set to 'Scan only', and an 'Est Time' label showing '20 s'. At the bottom, there is a 'Ready' status bar and a navigation bar with buttons for 'Start', 'Target', 'Camera', 'VwSc', 'VwImg', and 'Page'.

Field	Description
Field of View	Selection of Target All for a 360° x 290° area or Custom for a user defined area to scan and/or take pictures.
Hz/V Area: Left	Left limit of the area to scan or take pictures.
Hz/V Area: Right	Right limit of the area to scan or take pictures.
Hz/V Area: Top	Top limit of the area to scan or take pictures. All points with an elevation angle higher than the entered limit will not be stored.
Hz/V Area: +90 °	Set the top value to its maximum limit of +90 °.
Hz/V Area: Bottom	Bottom limit of the area to scan or take pictures. All points with an elevation angle lower than the entered limit will not be stored.
Hz/V Area: -55 °	Set the bottom value to its minimum limit of -55 °.
Task	<ul style="list-style-type: none"> • Scan only: Take a scan only, no images are acquired. • Images only: Acquire images only, no scan is started. • Scan & Image: Acquire scan and images.
Est. Time	Estimated duration of the defined scan and/or image process derived from the current settings in Field of View , Resolution and ImageCtrl .

Available commands:

Command	Function
Start	Start scan and/or image acquisition with selected FoV and resolution.
Target	Open the Target Definition screen to select target ID, target height and target type.
Camera	Open scan window for area selection from video stream image.
VwSc	View point cloud of last scan with zoom, pan and show previous/next functionality.
VwImg	View last image with next/previous functionality.
Page	Switch to the Resolution page.
Shift -> NewStn	Create a new station. (Only active when the current station is not empty.)
Shift -> Scale	Open the Scale Factor screen to define atmospheric and geometric corrections.
Shift -> ChkBS	Open Check Backsight screen to define a known backsight target for current setup control.
Icon: 	Open the General tab of the Settings menu to configure instrument settings.

Custom Field of View

15:17:54
Scan

myProject: Station-001

Field of View Resolution Image Ctrl Filter

Field of View: Custom

4.830 +90°

Hz / V Area [°] 270.336 332.918



-3.210 -55°

Task: Scan only

Est Time: 10 s

Ready

Start Target Camera VwSc VwImg Page



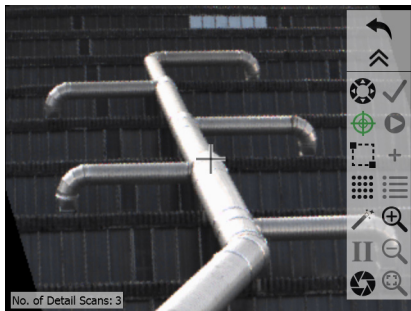

With **Field of View** set to **Custom** the **Left/Right** fields show the current scanner direction. To quickly define the left and right boundary of the scan/image area turn the scanner in the desired direction and set this direction by pressing the **Unlock** symbol  next to the corresponding field. The symbol changes to the **Lock** symbol  and the output field becomes an editable input field. Then edit the default **Bottom** and **Top** fields manually if needed. The **Bottom** and **Top** fields for the vertical field of view can be set to the maximum values by clicking on the **-55°** and **+90°** icons.









Camera screen



Field	Description
No. of Detail Scans	Number of selected scans in the Scan List.

Available commands:

Command		Function
Rotate		Press one of the four arrow buttons to rotate the scanner up, down, left or right. Once a button is pressed the scanner starts to move in the selected direction constantly. Press the video screen again at any position to stop the rotation. In activated mode the icon turns green.
Continue		Continue and return to the Field of View page of the Scan Parameters screen. The boundaries of a defined scan/image area will be copied into the corresponding fields of Hz / V Area.
Seek		Select a point in the video camera window to define it as the new window centre. The scanner rotates accordingly in horizontal and vertical direction to reposition the crosshair. In activated mode the icon turns green.
Scan		Return to Field of View page and start a scan only of the specified area.
Fence		Select the scan/image area by fencing the area in the current video camera image. In activated mode the icon turns green.

Command		Function
Add Scan		Add fenced scan area to Scan List .
Detail Scan Parameters		Open the Detail Scan Parameters panel and define settings for fenced sub-scans.
View Scan List		Open the Scan List to see the list of defined sub-scans.
Camera Wizard		Open the Camera Wizard to define the upper left and the lower right corner points of an area to be scanned.
Zoom In		Zoom in to the centre of the video camera image.
Face I/II	I II	Switch the internal camera between face I and face II.
Zoom Out		Zoom out from the centre of the video camera image.
Check Exposure		Open slider to adjust exposure time manually in the video camera window from 0 ms to 800 ms and transfer setting to the Time field of the Image Ctrl page in the Scan Parameters screen.
Zoom All		Zoom back to the camera's full field of view.



Multiple scan areas can be added to the scan list. They are all scanned with the settings defined in the Detail Scan Parameters screen. The resolution of each subscan can be different.

Scanning screen

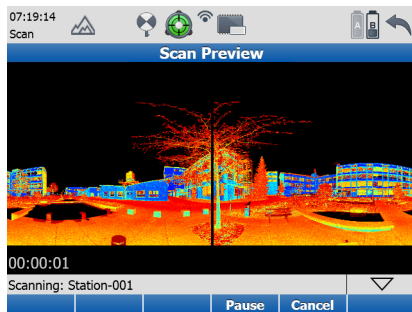

Field	Description
Real Time Scan Viewer	Display of current scan in progress.
Est Time	Estimated time to finish scan.





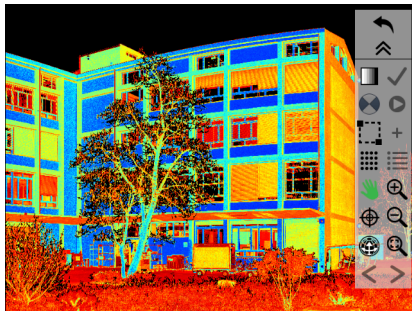

Available commands:









Command	Function
Pause	Pause current scan. Once paused the button changes to Resume . Press again to resume paused scan.
Cancel	Cancel current scan and return to the Field of View menu.









View scan screen



Available commands:

Command	Function
Colourise  	Switch between coloured  and black & white  intensity display.
Continue 	Continue and return to Field of View menu.
Target 	Open the Target Definition screen to select target ID, target height and target type.

Command	Function
Scan 	Return to Field of View menu and start a scan only of all scan areas as listed in the Scan List .
Fence 	Select the scan area by fencing the area. In activated mode the icon turns green.
Add Scan 	Add fenced scan area to Scan List . Once added to the Scan List the boundaries of each sub-scan are displayed in the Scan Viewer as a frame.
Detail Scan Parameters 	Open the Detail Scan Parameters panel and define settings for fenced sub-scans.
View Scan List 	Open the Scan List to see the list of defined sub-scans.
Pan 	Pan mode to move current scan on screen. In activated mode the icon turns green.
Zoom In 	Zoom in to the centre of the scan image.
Seek 	Select a point in the scan viewer to define it as the new centre. The entire point cloud is moved in horizontal and vertical direction accordingly. In activated mode the icon turns green.

Command		Function
Zoom Out		Zoom out from the centre of the scan image.
Move to Next Station		Move to the next traverse station after data collection on current station has been completed. Proceeds to the Define Backsight screen of the next traverse station. (Only available in Traverse workflow.)
View		Switch between 2D planar view  and 3D view  .
Zoom 1:1		Zoom back to fit complete scan to screen.
Previous		Show previous scan of current station.
Next		Show next scan of current station.



Multiple scan areas can be added to the scan list. They are all scanned with the settings defined in the **Detail Scan Parameters** screen. The resolution of each sub-scan can be different.



Each sub-scan of the Scan List is represented by a frame in the Scan Viewer. Once a sub-scan has been executed or deleted from the Scan List, the frame is removed from the Scan Viewer. The number of sub-scans is displayed in the lower left corner.

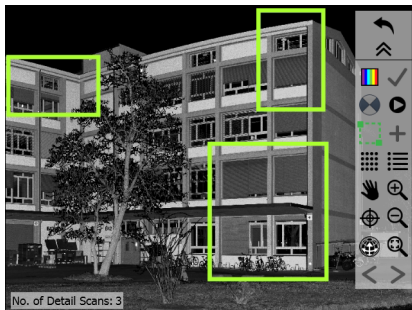

Field	Description
No. of Detail Scans	Number of selected scans in the Scan List.

7.3.2

Scanning\Scan Parameters\Resolution

Access

Select **Main Menu, Scanning**  , **Scan Parameters, Resolution**.

Description

In the **Resolution** page of the **Scan Parameters** screen the point spacing and sensitivity can be defined. For detailed information about the different options and commands that can be executed from this page refer to the descriptions on the following pages.

Resolution page

15:25:36
Scan

myProject: Station-001

Field of View Resolution Image Ctrl Filter

EDM Mode: Speed

Resolution: 6.3mm@10m

Sensitivity: Normal High

Est Time: 11 s

Ready

Start Target Camera Dist Custom Page

Field	Description
EDM Mode	Selection of Speed or Range mode (ScanStation P40 only).  With Range mode enabled the maximum scanning range is 270 m at a maximum sample rate of 500.000 pts/sec. With Speed mode enabled the maximum scanning range is 120 m at a maximum sample rate of 1.000.000 pts/sec.
Resolution	Selection of fixed resolution settings.

Field	Description
Sensitivity	Selection of scan sensitivity (ScanStation P40 only).  With Normal sensitivity the instrument receives less valid measurements of low return signals (e.g far away objects, low reflective surfaces) but at a higher sample rate. With High sensitivity the instrument gets more sufficient return signals but with a reduced sample rate.
Est Time	Estimated time for a scan using the current settings.

Scan duration (ScanStation P40, Speed mode):

Resolution [mm @ 10 m]	Estimated scan duration [HH:MM:SS] for a full dome scan @ sensitivity level	
	Normal	High
50	00:00:20	00:00:20
25	00:00:33	00:00:33
12.5	00:00:58	00:00:58
6.3	00:01:49	00:03:25
3.1	00:03:30	00:13:30
1.6	00:13:33	00:54:06
0.8	00:54:06	03:36:21

Scan duration (ScanStation P40, Range mode):

Resolution [mm @ 10 m]	Estimated scan duration [HH:MM:SS] for a full dome scan @ sensitivity level	
	Normal	High
50	00:00:20	00:00:28
25	00:00:33	00:00:53
12.5	00:00:58	00:01:44
6.3	00:01:49	00:06:47
3.1	00:06:47	00:26:59
1.6	00:27:04	01:48:12
0.8	01:48:12	03:36:21

Scan duration (ScanStation P30):

Resolution [mm @ 10 m]	Estimated scan duration [HH:MM:SS] for a full dome scan
50	00:00:20
25	00:00:33
12.5	00:00:58
6.3	00:01:49
3.1	00:03:30
1.6	00:13:33
0.8	00:54:07

Available commands:

Command	Function
Start	Start scan and/or image acquisition with selected FoV and resolution.
Target	Open the Target Definition screen to select target ID, target height and target type.
Camera	Open scan window for area selection from video stream image.
Dist	Open video camera window to measure the distance to the object to be scanned.
Custom/Default	Switch between default screen with fixed resolution settings and custom screen with flexible resolution settings for Hz and V (ScanStation P40 only).
Page	Switch to the Image Ctrl page.
New Stn	Create a new station. Only active when the current station is not empty.
Shift -> Scale	Open the Scale Factor screen to define atmospheric and geometric corrections.
Shift -> ChkBS	Open Check Backsight screen to define a known backsight target for current setup control.

Command	Function
Icon: 	Open the General tab of the Settings menu to configure instrument settings.

7.3.3

Scanning\Scan Parameters\Image Control\Internal Camera

Access

Select **Main Menu, Scanning** , **Scan Parameters, Image Ctrl.**

Description

In the **Image Ctrl** page of the **Scan Parameters** screen the parameters of the internal camera can be defined. Please refer to the descriptions on the following pages for detailed information about the different options and commands that can be executed from this page.

Image Ctrl page

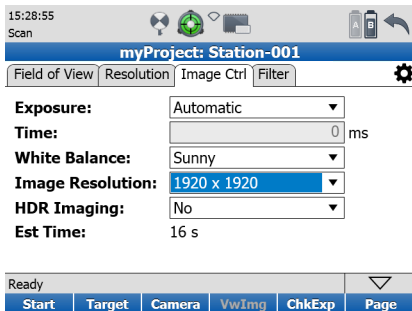

The screenshot shows the 'Image Ctrl' page of the ScanStation software. At the top, the status bar displays '15:28:55 Scan' and 'myProject: Station-001'. Below the status bar, there are tabs for 'Field of View', 'Resolution', 'Image Ctrl', and 'Filter', with a gear icon for settings. The 'Image Ctrl' page contains the following parameters:

Exposure:	Automatic
Time:	0 ms
White Balance:	Sunny
Image Resolution:	1920 x 1920
HDR Imaging:	No
Est Time:	16 s

At the bottom, there is a 'Ready' status bar and a navigation bar with buttons for 'Start', 'Target', 'Camera', 'VwImg', 'ChkExp', and 'Page'.

Field	Option	Description
Exposure	Automatic	Image exposure time for each single image is calculated automatically.
	Manual	Image exposure time is set manually. See Time field.
Time	-	Exposure time in ms (milliseconds) for manual exposure.
White Balance	Sunny	Automatic colour adjustment for sunny outdoor environment.
	Cloudy	Automatic colour adjustment for cloudy outdoor environment.
	Cold light	Automatic colour adjustment for indoor environment with light source of cold colour temperature (e.g. neon tube).
	Warm light	Automatic colour adjustment for indoor environment with light source of warm colour temperature (e.g. halogen lamp).
	Custom	Manual colour adjustment by user.

Field	Option	Description
Image Resolution	1920x1920	Set single image resolution to 1920 x 1920 pixels.
	960x960	Set single image resolution to 960 x 960 pixels.
	640x640	Set single image resolution to 640 x 640 pixels.
HDR Imaging	Yes	Enables HDR imaging for internal camera.
	No	Disables HDR imaging for internal camera.
Est Time	-	Estimated time for image acquisition using the current settings.

Available commands:



Command	Function
Start	Start scan and/or image acquisition with selected FoV and resolution.
Target	Open the Target Definition screen to select target ID, target height and target type.
Camera	Open scan window for area selection from video stream image.
VwImg	View last image with next/previous functionality.



Command	Function
ChExp	Open video camera window to allow for checking and adjusting exposure time for manual exposure time setting.
Page	Switch to the Filter page.
New Stn	Create a new station. Only active when the current station is not empty.
Shift -> Scale	Open the Scale Factor screen to define atmospheric and geometric corrections.
Shift -> CamOri	Start camera orientation process for external camera.
Shift -> ChkBS	Open Check Backsight screen to define a known backsight target for current setup control.
Shift -> WhitBal	Open video camera window for manual colour adjustment on a white reference plane.
Icon: 	Open the General tab of the Settings menu to configure instrument settings.

Check Exposure screen



Available commands:

Command		Function
Slider		Move slider to adjust exposure time in the video camera window from 0 ms to 800 ms and transfer setting to the Time field of the Image Ctrl page in the Scan Parameters screen.
Continue		Continue and return to the Image Ctrl page of the Scan Parameters screen.

Command	Function
Rotate 	Press one of the four arrow buttons to rotate the scanner up, down, left or right. Once a button is pressed the scanner starts to move in the selected direction constantly. Press the video screen again at any position to stop the rotation. In activated mode the icon turns green.
Seek 	Select a point in the video camera window to define it as the new window centre. The scanner rotates accordingly in horizontal and vertical direction to reposition the crosshair. In activated mode the icon turns green.
Face I/II I II	Switch the internal camera between face I and face II.
Auto Check Exposure 	Set exposure time automatically in the video camera window and transfer setting to the Exposure field of the Image Ctrl page in the Scan Parameters screen.

Capture Images screen

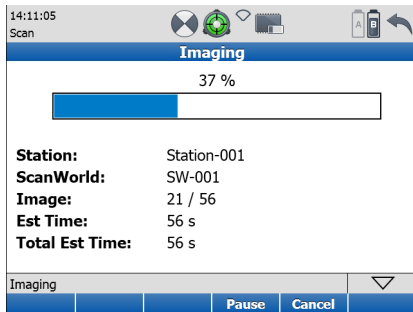

Field	Description
Progress bar	Image acquisition progress in percent.
Station	Name of the current station.
ScanWorld	Name of the current ScanWorld.
Image	Number of images already acquired / number of total images to be acquired.
Est Time	Estimated time for image acquisition using the current settings.

Field	Description
Total Est Time	Total estimated time for scan and image acquisition using the current settings.

Available commands:

Command	Function
Pause	Pause current image acquisition process. Once paused the button changes to Resume . Press again to resume paused image acquisition process.
Cancel	Cancel the current image acquisition process and return to the Image Ctrl page in the Scan Parameters screen.

7.3.4

Scanning\Scan Parameters\Image Control\External Camera

Access

Select **Main Menu, Scanning** , **Scan Parameters, Image Ctrl, External Camera.**

Description

In the **Image Ctrl** page for the external camera the parameters of the exterior camera orientation can be determined and the external camera can be controlled for image acquisition.

External Camera page

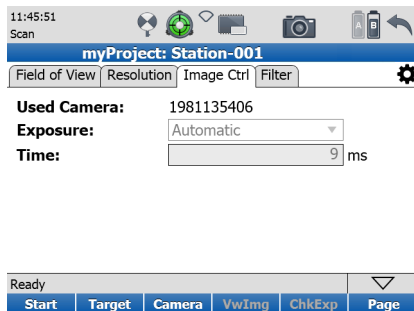

The screenshot shows the 'External Camera' page of the software. At the top, there is a status bar with the time '11:45:51' and the word 'Scan'. Below this is a blue header bar with the text 'myProject: Station-001'. Underneath the header is a navigation bar with tabs for 'Field of View', 'Resolution', 'Image Ctrl', and 'Filter', along with a gear icon for settings. The main area contains the following controls:

- Used Camera:** 1981135406
- Exposure:** Automatic (dropdown menu)
- Time:** 9 ms (input field)

At the bottom of the page, there is a 'Ready' status bar and a navigation bar with buttons for 'Start', 'Target', 'Camera', 'VwImg', 'ChkExp', and 'Page'.



For details about the external camera setup, the wizard for the initial calculation of interior and exterior camera parameters and the calibration process refer to the External Camera Calibration Wizard Manual.



To be able to use the external camera a valid external camera license must be available (refer to "12.3 Tools\License").

Field	Option	Description
Used Camera	Name of external camera	Serial number of external camera or camera name as entered in the camera calibration process. Reads the camera parameters of the selected camera.
Exposure	Automatic	Image exposure time for each single image is calculated automatically (mode dial on camera is set to Av = Aperture value).
	Manual	Image exposure time is set manually (mode dial on camera is set to M = Manual). See Time field.
Time	-	Exposure time in ms (milliseconds) for manual exposure.

Available commands:



Command	Function
Start	Start scan and/or external camera image acquisition with selected FoV and resolution.
Target	Open the Target Definition screen to select target ID, target height and target type.
Camera	Open scan window for area selection from video stream image.
VwImg	View last image of external camera with next/previous functionality.
ChExp	With exposure time set to Manual (setting M on the mode dial) the Check Exposure screen opens to allow for checking and adjusting exposure time.
Page	Switch to the Filter page.
New Stn	Create a new station. Only active when the current station is not empty.
Shift -> Scale	Open the Scale Factor screen to define atmospheric and geometric corrections.
Shift -> CamOri	Start camera orientation process for external camera.

Command	Function
Shift -> ChkBS	Open Check Backsight screen to define a known backsight target for current setup control.
Shift -> WhitBal	Open video camera window for manual colour adjustment on white reference plane.
Icon: 	Open the General tab of the Settings menu to configure instrument settings.

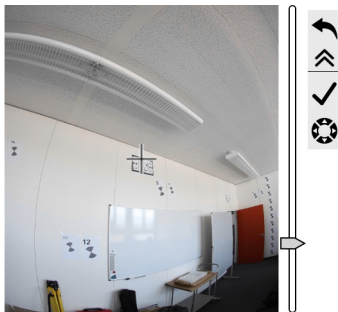
Check Exposure screen



Available commands:

Command	Function
Slider 	Move slider to adjust exposure time in the external camera LCD screen and transfer setting to the Time field of the Image Ctrl page in the Scan Parameters screen.
Continue 	Continue and return to the Image Ctrl page of the Scan Parameters screen.
Rotate 	Press one of the two arrow buttons to rotate the scanner left or right. Once a button is pressed the scanner starts to move in the selected direction constantly. Press the video screen again at any position to stop the rotation.

Capture Images screen

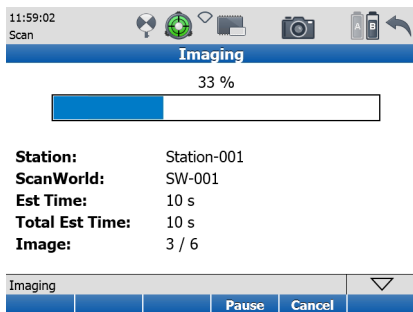

Field	Description
Progress bar	Image acquisition progress of external camera in percent.
Station	Name of the current station.
ScanWorld	Name of the current ScanWorld.
Est Time	Estimated time to finish imaging.
Total Est Time	Total estimated time for scan and image acquisition using the current settings.

Field	Description
Image	Number of images already acquired / number of total images to be acquired.

Available commands:

Command	Function
Pause	Pause current external camera image acquisition process. Once paused the button changes to Resume . Press again to resume paused image acquisition process.
Cancel	Cancel the current external camera image acquisition process and return to the Image Ctrl page in the Scan Parameters screen.

Define External Camera Orientation Target List screen

12:07:46
Scan



Target List		
Target ID	Type	Height
CamOri-1	Leica B/W 4.5"	0.0000 m
CamOri-2	Leica B/W 4.5"	0.0000 m

Ready

Cont		Del		
------	--	-----	--	--

Field	Description
Target ID	List of all defined target IDs to be acquired for camera orientation. These targets will be used for the calculation of the camera orientation.
Type	Target type of the selected target ID.
Height	Target height of the selected target ID.

Available commands:

Command	Function
Cont	Continue and start target acquisition process for all targets listed in Target List .
Del	Delete the selected target from the Target List .



The external camera orientation process (**CamOri**) calculates the orientation parameters (3 rotations) of the external camera for each Station/ScanWorld. It should be executed every time the external camera has been taken off the instrument. The target(s) should be placed within a recommended distance of 2 m to 8 m and an elevation angle of about 0° (same height as instrument). When the external camera orientation process is skipped in the field then the Pose Editor will open during import in Cyclone for image alignment.



The **CamOri** process does not trigger a new station. All parameters are written into the current station and are saved to all subsequent stations until a new **CamOri** process is executed. Then the new camera orientation parameters are applied to all subsequent stations in the project. After a reboot the old camera orientation parameters are retained in the current project.



The parameters of the **CamOri** process are written to the current project and are project depending. For a new project new camera parameters have to be created by an additional **CamOri** process.



When the connection to the external camera was interrupted since the last **CamOri** process was executed, then a reminder opens and the user can chose to execute a new **CamOri** process (**Yes**) or to continue with the existing parameters (**No**).

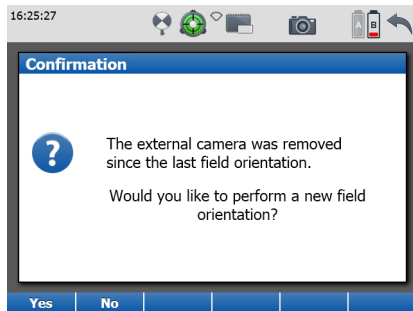

Define External Camera Orientation Target Results screen

12:13:37
Setup



Target Results			
Target ID	Image	Δ Pixel	Use
CamOri-1	1	2.45	Yes
CamOri-1	2	2.94	Yes
CamOri-2	3	2.12	Yes
CamOri-2	4	2.86	Yes

Ready

Store	VwImg	VwTgt	Use		
					▽

Field	Description
Target ID	Target ID of scanned target.
Image	Image number.
ΔPixel	Target residuals to image (in pixels).
Use	Target status for calculation of camera orientation (Yes = used, No = not used).

Available commands:

Command	Function
Store	Store external camera orientation results and return to Scan Parameters screen.
VwImg	View selected image with next/previous functionality.
VwTgt	View selected target.
Use	Change the target status in the Use field from Yes to No .

7.3.5

Scanning\Scan Parameters\Filter

Access

Select **Main Menu, Scanning** , **Scan Parameters, Filter**.

Description

In the **Filter** page of the **Scan Parameters** screen filters for the minimum and maximum range of scanned points can be set.

Filters page

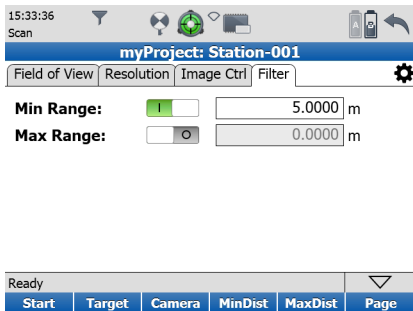

The screenshot shows the 'Filter' page of the Scan Parameters screen. At the top, there is a status bar with the time '15:33:36', the word 'Scan', and several icons. Below this is a blue header bar with the text 'myProject: Station-001'. Underneath the header are four tabs: 'Field of View', 'Resolution', 'Image Ctrl', and 'Filter', with a gear icon to the right. The 'Filter' tab is active. Below the tabs, there are two rows of controls. The first row is labeled 'Min Range:' and has a green slider set to the left, a text input field containing '5.0000', and a unit 'm'. The second row is labeled 'Max Range:' and has a grey slider set to the right, a text input field containing '0.0000', and a unit 'm'. At the bottom of the screen, there is a 'Ready' status bar with a dropdown arrow on the right. Below the status bar are six buttons: 'Start', 'Target', 'Camera', 'MinDist', 'MaxDist', and 'Page'.

Field	Description
Min Range	Enable or disable range filtering for minimum range. All points with a range lower than the entered limit will not be stored.
Max Range	Enable or disable range filtering for maximum range. All points with a range higher than the entered limit will not be stored.



Once range filtering is enabled the  icon in the status bar is visible. At system start the range filtering is disabled by default.

Available commands:

Command	Function
Start	Start scan and/or image acquisition with selected FoV and resolution.
Target	Open the Target Definition screen to select target ID, target height and target type.
Camera	Open scan window for area selection from video stream image.
MinDist	Open video camera window to select a point from video stream image for a probe distance measurement which is entered in the Min Range field.

Command	Function
MaxDist	Open video camera window to select a point from video stream image for a probe distance measurement which is entered in the Max Range field.
Page	Switch to the Detail Scan page.
Shift -> Scale	Open the Scale Factor screen to define atmospheric and geometric corrections.
Shift -> ChkBS	Open Check Backsight screen to define a known backsight target for current setup control.
Icon: 	Open the General tab of the Settings menu to configure instrument settings.

7.3.6 Scanning\Detail Scan Parameters

Access

In **Scan Parameters** select **Field of View, Camera** or after a scan has finished select **Detail Scan Parameters** in the **Scan Viewer**.

Description

In the **Detail Scan Parameters** screen the point spacing and sensitivity for fenced sub-scans can be defined. For detailed information about the different options and commands that can be executed from this page refer to the descriptions on the following pages.

Detail Scan Parameters, Resolution page

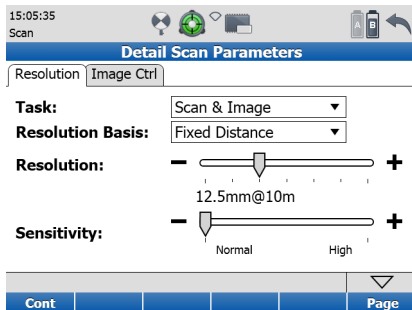

Field	Description
Task	Scan only: Take a scan only, no images are acquired. Images only: Acquire images only, no scan is started. Scan & Image: Acquire scan and images.
Resolution Basis	With Fixed Distance the horizontal and vertical resolution apply to objects at a distance of 10 m from the instrument. With Distance to Object all objects are scanned with the same resolution regardless of the distance.
Resolution	Selection of fixed resolution settings.
Sensitivity	Selection of point cloud sensitivity (ScanStation P40 only).

Available commands:

Command	Function
Cont	Confirm Detail Scan Parameters and continue to the previous menu.
Page	Switch to the Image Ctrl page.

Detail Scan Parameters, Image Ctrl page

15:14:08
Scan

Detail Scan Parameters

Resolution Image Ctrl

Exposure: Automatic ▼

Time: 0 ms

White Balance: Sunny ▼

Image Resolution: 960 x 960 ▼

HDR Imaging: No ▼

					▼
Cont			ChkExp	Page	

Field	Option	Description
Exposure	Automatic	Image exposure time for each single image is calculated automatically.
	Manual	Image exposure time is set manually. See Time field.
Time	-	Exposure time in milliseconds (ms) for manual exposure.

Field	Option	Description
White Balance	Sunny	Automatic colour adjustment for sunny outdoor environment.
	Cloudy	Automatic colour adjustment for cloudy outdoor environment.
	Cold Light	Automatic colour adjustment for indoor environment with light source of cold colour temperature, for example neon tube.
	Warm Light	Automatic colour adjustment for indoor environment with light source of warm colour temperature, for example halogen lamp.
	Custom	Manual colour adjustment by user.
Image Resolution	1920 x 1920	Set single image resolution to 1920 x 1920.
	960 x 960	Set single image resolution to 960 x 960.
	640 x 640	Set single image resolution to 640 x 640.
HDR Imaging	Yes	Enables HDR imaging for internal camera.
	No	Disables HDR imaging for internal camera.

Available commands:

Command	Function
Cont	Confirm Detail Scan Parameters and continue to the previous menu.
ChkExp	Open the video camera window to allow checking and adjusting exposure time for manual exposure time setting.
Page	Switch to Resolution page.

7.3.7

Scanning\Scan Parameters\...\Target Definition

Access

Select **Main Menu, Scanning** , **Scan Parameters, Target** or

press the active target icon  in the status bar to access the **Target Definition** screen directly or





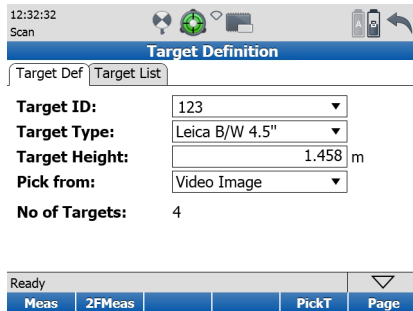

press the target icon  in the scan viewer.

Description

In the **Target Definition** screen all options for target acquisition are available.

Target Def page



12:32:32						
Scan						
Target Definition						
Target Def		Target List				
Target ID:	123					
Target Type:	Leica B/W 4.5"					
Target Height:	1.458 m					
Pick from:	Video Image					
No of Targets:	4					
Ready					▼	
Meas	2FMeas			PickT	Page	

Field	Description
Target ID	Target ID. May include letters such as A-Z, a-z, numbers from 0-9 and any special characters of the virtual keyboard except "[" and "]". Press the field to define a new target or the arrow icon to select existing targets from a list.
Target Type	List of target types which are supported by the scanner.
Target Height	Target height in meters from target base point to target centre.
Pick from	Select the source for target picking. With Video Image selected the PickT command opens the video camera image for target selection. With Scan selected the PickT command opens the scan viewer for target selection. With Red Laser selected the PickT command activates the red laser for target selection.
No of Targets	Number of picked targets to be scanned.

Target Type:

Type	Description
B/W Target 6"	HDS 6" Black&White circular planar target.
Leica B/W 4.5"	Leica 4.5" Black&White circular target.

Type	Description
B/W Target 3"	HDS 3" Black&White target.
HDS Sphere	HDS 6" spherical target.

Available commands:

Command	Function
Meas	Continue and start target acquisition process for all targets listed in the Target List page.
2FMeas	Continue and start target acquisition process in face 1 and 2 for all targets listed in Target List .
PickT/Add	Select target centre from the video camera image (Video Image) or from an existing scan (Scan). After selection, the target is listed on the Target List page as a candidate for target acquisition. Changes to Add when the Red Laser option is activated.
Page	Switch to the Target List page.
Shift -> Cnfg	Open the Target ID Configuration screen to define a target ID prefix which is incremented by one for each new target. The defined prefix is the default entry in the Target ID field.

Target List page

12:26:47
Scan

Target Definition

Target Def Target List

Target ID	Type	Height
123	Leica B/W 4.5"	0.0000 m
t45	B/W Target 6"	0.0000 m
T-1	B/W Target 3"	0.0000 m
S1	HDS Sphere	0.0000 m

Ready

Meas 2FMeas Edit Del Page

Field	Description
Target ID	List of all defined target IDs to be acquired.
Type	Target type of the selected target ID.
Height	Shows the target height of the selected target after PickT was executed.

Available commands:





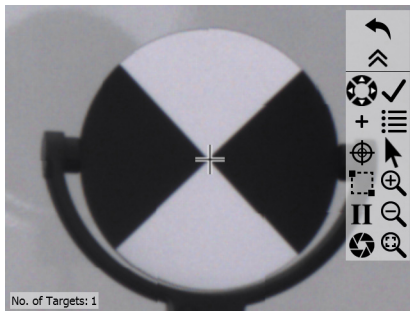

Command	Function
Meas	Continue and start target acquisition process for all targets listed in Target List .
2FMeas	Continue and start target acquisition process in face 1 and 2 for all targets listed in Target List .
Edit	Open the Edit Target menu to edit the selected target.
Del	Delete the selected target from the Target List .
Page	Switch to the Target Def page.







Pick Target from
video image



Field	Description
No. of Targets	Number of selected targets in the Target List .

Available commands:

Command		Function
Navigate		Press one of the four arrow buttons to rotate the scanner up, down, left or right. Once a button is pressed the scanner starts to move in the selected direction constantly. Press the video screen again at any position to stop the rotation. In activated mode the icon turns green.
Continue		Continue and return to Target Def menu.
Add Target		Add selected target to the Target List . Deactivated when no target ID template has been configured.
View Target List		Open the Target List to see the list of defined targets.
Seek		Select a point in the video camera window to define it as the new window centre. The scanner rotates accordingly in horizontal and vertical direction to reposition the crosshair. In activated mode the icon turns green.
Pick		Pick the target centre. In activated mode the icon turns green.

Command	Function
Fence 	Select the target by fencing the area. By pressing ✓ the fenced area is scanned with a default resolution so that the user can pick the target centre from the point cloud of the fenced area. In activated mode the icon turns green.
Zoom In 	Zoom in to the centre of the video image.
Face I/II 	Switch the internal camera between face I and face II.
Zoom Out 	Zoom out from the centre of the video image.
Check Exposure 	Open slider to adjust exposure time manually in the video camera window from 0 ms to 800 ms and transfer setting to the Time field of the Image Ctrl page in the Scan Parameters screen.
Zoom All 	Zoom back to the camera's full field of view.



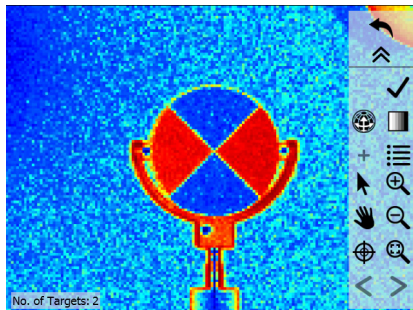















Pick Target from
scan viewer





Field	Description
No. of Targets	Number of selected targets in the Target List .

Available commands:

Command	Function
Continue	Continue and return to Target Def menu.

Command	Function
View  	Switch between 2D planar view  and 3D view  .
Colourise  	Switch between coloured  and black & white  intensity display.
Add Target 	Add selected target to the Target List . Deactivated when no target ID template has been configured.
View Target List 	Open the Target List to see the list of defined targets.
Pick  	Pick the target centre. In activated mode the icon turns green.
Zoom In 	Zoom in to the centre of the scan image.
Pan  	Pan mode to move current scan on screen. In activated mode the icon turns green.
Zoom Out 	Zoom out from the centre of the scan image.
Seek  	Select a point in the scan viewer to define it as the new centre. The entire point cloud is moved in horizontal and vertical direction to reposition the selected point. In activated mode the icon turns green.

Command		Function
Zoom 1:1		Zoom back to fit complete scan to screen.
Previous		Show previous scan on current station.
Next		Show next scan on current station.

Target Scan Progress screen

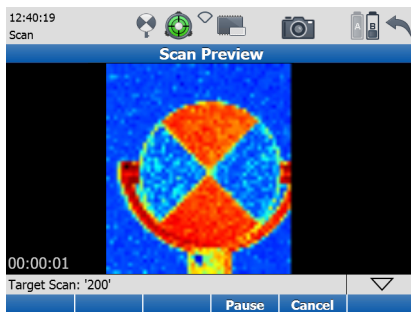

Field	Description
Real Time Scan Viewer	Display of current target scan in progress.
Est Time	Estimated time to finish current target scan.

Available commands:

Command	Function
Pause	Pause current target scan process. Once paused the button changes to Resume . Press again to resume paused target scan process.
Cancel	Cancel current target scan process and continue to the Target Results screen.

Target Results screen

Target ID	Target Type	State
123	Leica B/W 4.5"	OK
S1	HDS Sphere	OK
T-1	B/W Target 3"	OK
t45	B/W Target 6"	OK

Ready					▽
Store	Dist	Info	Del	View	

Field	Description
Target ID	Target ID of scanned target.
Target Type	Target type of scanned target.
State	Status of scanned target. OK indicates a successful acquisition of the target centre. A bad target centre acquisition is marked as BAD .





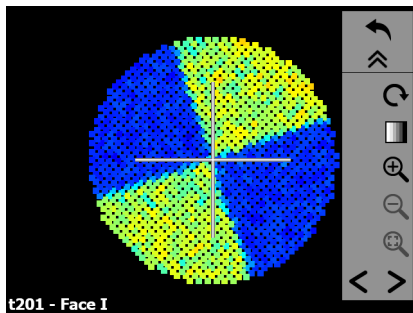

Available commands:





Command	Function
Store	Store all targets listed in the Targets Results list.
Dist	Open Distance between Targets screen to measure slope distance between two targets in a ScanWorld.
Info	Open Info Targets Results screen with information about the selected target.
Del	Delete selected target from the Targets Results list.
View	View point cloud of selected target scan.
Shift -> Re-Pick	Open the scan viewer to pick and scan the target again.
Shift -> Redo	Repeat target scan of target which has been selected in the Target Results list.

View Target screen



Available commands:

Command	Function
Rotate 	Rotate the target point cloud by increments of 30°.
Change colour  	Switch between coloured  and black & white  intensity display.
Zoom In 	Zoom in to the centre of the scan image.

Command		Function
Zoom Out		Zoom out from the centre of the scan image.
Zoom 1:1		Zoom back to fit complete target scan to screen.
Previous		Show previous target.
Next		Show next target.

Confirmation message

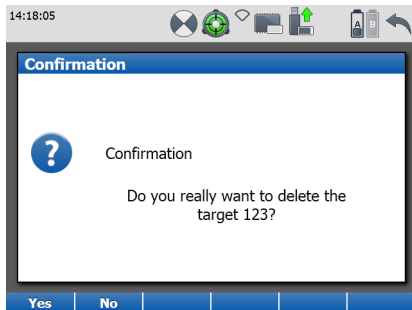

Option	Description
Yes	Confirm deletion of selected target and return to the Targets Results screen.
No	Cancel deletion of selected target and return to the Targets Results screen.

Target Information screen

14:19:16
Scan



Target Information

Target ID: 123
Target Type: B/W Target 6"
Northing: -1.3748 m
Easting: 1.9003 m
Height: -1.2521 m
Distance: 2.6587 m

Ready



Cont Prev Next

Field	Description
Target ID	Target ID of selected target.
Target Type	Target type of selected target.
Northing	Northing of target.
Easting	Easting of target.
Height	Height of target base point.
Distance	Slope distance from scanner base point to target base point.

Available commands:

Command	Function
Cont	Continue and return to Target Results screen.
Prev	Show target information of previous target.
Next	Show target information of next target.

Distance between Targets screen



Field	Description
From Target	Select first target for distance measurement.
To Target	Select second target for distance measurement.
Slope Dist	Slope distance between selected targets.
Hz Dist	Horizontal distance between selected targets.
Height Diff	Height difference between selected targets.

8

Traverse

Access

Select **Main Menu, Traverse**



Description

In the **Traverse** menu a chain of new stations can be generated to be used as the foundation for further scanning and imaging. All new stations and their elements are registered to a common coordinate reference with no office registration required. The workflow supports the calculation of closed loop traverses and linear traverses with or without measurement of the closing angle.

8.1



Traverse Begin

Description



In the **Traverse Begin** screen new projects and traverses can be created. **Traverse Management** and **Traverse Configuration** can be accessed from here and once defined a traverse can be started.

Traverse Begin screen



Project: 
Traverse ID: 



Field	Description
Project	Shows the current project. Click the name field to open a list of available projects. Click the  icon to open the Manage Projects screen for selecting another project, adding a new project, editing or deleting an existing project and displaying project details.
Traverse ID	Shows the current traverse. Click the name field to open a list of available traverses. Click the  icon to open the Traverse Management screen for selecting another traverse, adding a new traverse, editing or deleting an existing traverse and displaying traverse details.

Available commands:

Command	Function
Cont	Continue with the current traverse. Depending on the traverse status a different screen will open: <ul style="list-style-type: none">• New traverse: Opens the Station Setup screen.• Open traverse: Opens the Backsight Definition screen.• Closed traverse: Opens the Traverse Results screen.• Adjusted traverse: Opens the Adjustment Results screen.
Cnfg	Open the Traverse Configuration screen to define limits and specifications for the traverse workflow.
Close	Becomes active when the selected traverse can be closed (fore-sight measurement to a known point has been performed) and opens the Traverse Results screen.
Shift -> Scale	Open the Scale Factor screen to define atmospheric and geometric corrections.

8.2 Traverse Configuration

Description

In the **Traverse Configuration** screen limits and specifications for the whole traverse workflow can be set.

General page

The screenshot shows the 'Traverse Configuration' application interface. At the top, there is a status bar with the time '12:53:43', the word 'Traverse', and several system icons (signal, battery, Wi-Fi, and a mobile device). Below this is a blue header bar with the title 'Traverse Configuration'. Underneath the header, there are two tabs: 'General' (selected) and 'Plot'. The main content area contains the following settings:

- 2-face Target Scan:** A toggle switch that is currently turned off.
- Position Limit:** A green indicator bar, a text input field containing '0.015', and the unit 'm'.
- Height Limit:** A green indicator bar, a text input field containing '0.015', and the unit 'm'.
- Measm. Sequence:** A dropdown menu with 'BS-FS-Data' selected.
- Traverse ID Prefix:** A text input field containing 'Traverse-'.
- Foresight ID Prefix:** An empty text input field.

At the bottom of the screen, there is a status bar with the word 'Ready' on the left and a dropdown arrow on the right. Below this is a blue navigation bar with the text 'Cont' on the left and 'Page' on the right.

Field	Options	Description
2-face Target Scan	Off	Enable target scanning for traversing in one face only.
	On	Enable target scanning for traversing in two faces.
Position Limit	On	Enable checking of horizontal coordinate difference (hz range) between existing and measured known backsight point. If defined Position Limit is exceeded, the setup can be repeated, skipped or stored.
	Off	Disable checking of horizontal coordinate difference (hz range) between existing and measured known backsight point.
Height Limit	On	Enable checking of vertical difference between existing and measured known backsight point. If defined Height Limit is exceeded, the setup can be repeated, skipped or stored.
	Off	Disable checking of vertical difference between existing and measured known backsight point.

Field	Options	Description
Measm. Sequence	BS-FS-Data	Define the measurement sequence in the traverse workflow as Backsight-Foresight-Data.
	BS-Data-FS	Define the measurement sequence in the traverse workflow as Backsight-Data-Foresight.
Traverse ID Prefix	-	Enter a prefix for the traverse ID. Default setting is Traverse- . The increment is 001, 002, 003 , etc.
Foresight ID Prefix	-	Enter a prefix for the foresight ID. The increment is 001, 002, 003 , etc.

Available commands:

Command	Function
Cont	Confirm settings for Traverse Configuration and continue with the Traverse Begin screen.
Page	Switch to the Plot page.

Plot page

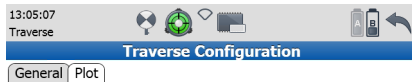

Field	Options	Description
Show Station ID	On	Display Station IDs in the Plot of the Traverse Data .
	Off	Hide Station IDs in the Plot of the Traverse Data .

Field	Options	Description
Show Side Shot	On	Display Side Shots in the Plot of the Traverse Data .
	Off	Hide Side Shots in the Plot of the Traverse Data .

Available commands:

Command	Function
Cont	Confirm settings for Traverse Configuration and continue with the Traverse Begin screen.
Page	Switch to the General page.

8.3

Traverse Management

Description

In the **Traverse Management** a list of all existing traverses in a project is provided for managing new and existing traverses.

Traverse Management screen

Traverse ID ▲	No of Stn	Status
Traverse-001	4	Adjusted
Traverse-002	2	Closed
myTraverse	3	Closed
Traverse-003	0	Open

Ready	▽				
Cont	New	Edit	Del	Data	Results

Field	Options	Description
Traverse ID	-	List of available traverses in the project.
No of Stn	-	Number of stations of a traverse.

Field	Options	Description
Status	Open	A new traverse always has the status Open .
	Closed	A traverse can be Closed when a foresight measurement to a control point has been performed.
	Adjusted	An Adjusted traverse is a closed traverse with angular and coordinate misclosures equally distributed over the stations of the traverse.

Available commands:

Command	Function
Cont	Confirm selection and return to the Traverse Begin screen.
New	Create a new traverse with traverse ID, description and creator.
Edit	Edit traverse ID, description and creator of an existing traverse.
Del	Delete selected traverse (after confirmation).
Data	Show details of selected traverse such as station IDs, backsight IDs, foresight IDs and plot of the traverse elements.

Command	Function
Results / Close	Results is active when the status of the selected traverse is Closed or Adjusted . Opens the Traverse Results screen or the Adjustment Results screen. Close is active when the status of the selected traverse is Open . Opens the Traverse Results screen.

8.3.1

New Traverse

Description

In the **New Traverse** screen a new traverse can be created with details such as name, description and creator.

New Traverse screen

14:41:24
Traverse

New Traverse

Traverse ID:

Description:

Creator:

Date:

Ready

Store

Field	Description
Traverse ID	Enter a unique traverse ID. Input is mandatory.
Description	Enter a short description of the traverse. Input is optional.

Field	Description
Creator	The person's name/abbreviation who is creating the traverse. Input is optional.
Date	Date of creation. Appears automatically and cannot be edited.

Available commands:

Command	Function
Store	Store the new traverse with description, creator and date and return to the Traverse Management screen.

8.3.2

Edit Traverse

Description

In the **Edit Traverse** screen the name, description and creator of an existing traverse can be altered.

Edit Traverse screen

14:47:23
Traverse

Edit Traverse

Traverse ID:

Description:

Creator:

Date:

Ready

Store

Field	Description
Traverse ID	Edit name of selected traverse.
Description	Add or edit traverse description.

Field	Description
Creator	Add or edit creator details.
Date	Creation date of selected traverse (not editable).

Available commands:

Command	Function
Store	Store new information and return to the Traverse Management screen.

8.3.3

Delete Traverse

Description

In the **Delete Traverse** screen an existing traverse can be deleted.

Delete Traverse screen

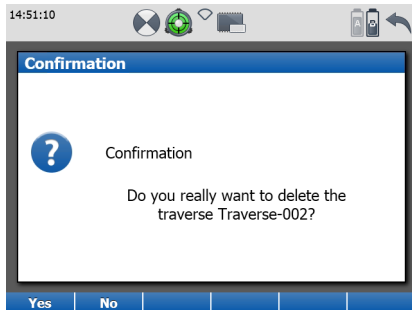

Available commands:

Command	Function
Yes	Confirm deletion of selected traverse.  A deleted traverse cannot be restored! Only the information about the traverse structure will be deleted. Stations, scans, images and target scans will not be deleted.
No	Decline deletion of selected traverse.

8.3.4 Traverse Data

Description

In the **Traverse Data** screen details of a traverse are available such as stations, backsights and foresights. A plot of the traverse with its elements can be displayed.

Points page

Station ID	Backsight ID	Foresight ID
1	A	2
2	1	3
3	2	A
A	3	1

Field	Description
Station ID	List of all available stations in the selected traverse.
Backsight ID	Corresponding backsight ID of a traverse station.

Field	Description
Foresight ID	Corresponding foresight ID of a traverse station.

Available commands:

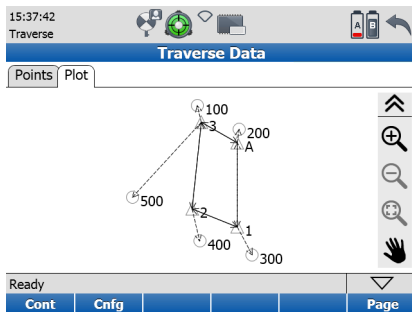

Command	Function
Cont	Return to the previous screen.
Edit	Open the Edit Station Data screen. (Deactivated for traverses with status Adjusted .)
Page	Switch to the Plot page.

Plot page



Available commands:

Command		Function
Zoom In		Zoom in to the centre of the plot.
Zoom Out		Zoom out from the centre of the plot.
Zoom 1:1		Zoom back to fit complete plot to screen.

Command	Function
Pan  	Pan mode to move current traverse plot on screen. In activated mode the icon turns green.
Cont	Return to the previous screen.
Cnfg	Open the Traverse Configuration screen to define the visibility of plot elements.
Page	Switch to the Points page.



Traverse stations with known coordinates are represented by a **▲** icon, sideshot stations and traverse stations with unknown coordinates are represented by a **○** icon. Measurements from a traverse station to another traverse station are represented by a solid line with an arrow end style, measurements from a traverse station to a sideshot station are represented by a dashed line with an arrow end style.

8.4 Starting a Traverse

Description

A traverse requires a start station and orientation which can be setup by any of the existing setup methods (refer to chapter "7.2 Scanning\Setup"). After successful setup of the start station the **Define Foresight** screen will be shown.

Station Setup screen

08:38:20
Setup

Station Setup

Setup Method: Set Azimuth

Ctrl Pnt Project: Traverse

Station ID: 1

Instrument Ht: 1.7200 m

Ready

Cont Cnfg New

Field	Description
Setup Method	Select the station setup. Known Backsight is set as the default method.

Field	Description
Ctrl Pnt Project	Select the project which contains the current station control point.
Station ID	Select the station ID of the current station.
Instrument Ht	Enter the instrument height (control point to tilt axis).

Available commands:

Command	Function
Cont	Confirm station input and continue with the selected setup method.
Cnfg	Open the Setup Configuration screen to define limits and attributes of the various setup methods.
New	Open the New Control Point screen to create a new control point in the selected project.



The following pages show **Set Azimuth** as an example of how to setup the first traverse station and its orientation. Other setup methods as described in chapter "7.2 Scanning\Setup" can also be used.

Set Azimuth Results screen, Stn & Tgt

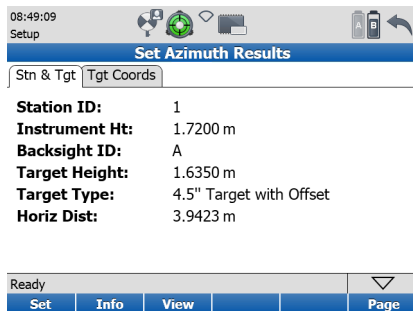

08:49:09
Setup

Set Azimuth Results

Stn & Tgt | Tgt Coords

Station ID: 1
Instrument Ht: 1.7200 m
Backsight ID: A
Target Height: 1.6350 m
Target Type: 4.5" Target with Offset
Horiz Dist: 3.9423 m

Ready

Set | Info | View | Page

Field	Description
Station ID	Station ID of current station.
Instrument Ht	Instrument height as entered.
Backsight ID	Target ID of the selected backsight target.

Field	Description
Target Height	Target height as entered.
Target Type	Target type of the selected backsight target.
Horiz Dist	Horizontal distance between station and backsight target.

Available commands:

Command	Function
Set	Accept the setup results for this station and proceed to Define Foresight screen.
Info	Show the target information of the selected target.
View	View point cloud of selected backsight target scan.
Shift -> Redo	Repeat backsight target scan of selected target and setup calculation.
Page	Switch to the Tgt Coords page.

Set Azimuth Results screen, Tgt Coords

08:49:52
Setup

Set Azimuth Results

Stn & Tgt Tgt Coords

Backsight ID: A
Northing: 1003.9423 m
Easting: 5000.0000 m
Height: 9.9853 m

Ready

Set Info View Page

Field	Description
Backsight ID	Target ID of the selected backsight target.
Northing	Northing of the selected backsight target calculated from scanned target data and user defined azimuth.
Easting	Easting of the selected backsight target calculated from scanned target data and user defined azimuth.
Height	Height of the selected backsight target calculated from scanned target data.

Available commands:

Command	Function
Set	Accept the setup results for this station and proceed to Define Foresight screen.
Info	Show the target information of the selected target.
View	View point cloud of selected backsight target scan.
Shift -> Redo	Repeat backsight target scan of selected target and setup calculation.
Page	Switch to the Stn & Tgt page.

8.5 Traverse Foresight

Description

The **Define Foresight** screen is used to define the next station of a traverse. It allows for input of necessary foresight station details such as foresight ID, target type and target height.

Define Foresight screen, Target Def

08:52:59
Setup

Define Foresight

Target Def Target List

Foresight ID:

Target Type:

Target Height: m

Ready

Cont PickT Page

Field	Description
Ctrl Pnt Project	Select the project which contains the current station control point.  Only visible when foresight station is a point with known coordinates (closing point).
Foresight ID	Enter the target ID of a new foresight target. A Foresight ID will be generated automatically when a Foresight ID prefix has been defined.
Target Type	Enter the target type of the foresight target.
Target Height	Enter the target height of the foresight target.

Available commands:

Command	Function
Cont	Start foresight target scan. Show results in Foresight Results screen.
PickT	Select target from the video image. After selection, the target is listed on the Target List page.
Shift -> Skip FS	Skip foresight and proceed to the Scan Parameters screen.

Command	Function
Page	Switch to the Target List page.

Define Foresight screen, Target List

08:57:05
Setup



Define Foresight

Target Def Target List

Target ID	Type	Height	State
2	4.5" Target with	1.7260 m	-----

Ready

Cont					Page
------	--	--	--	--	------

Field	Description
Target ID	Shows the target ID of a new foresight target after PickT was executed.
Type	Shows the target type of the foresight target.

Field	Description
Height	Shows the target height of the foresight target.

Available commands:

Command	Function
Cont	Start foresight target scan. Show results in Foresight Results screen.
Page	Switch to the Target Def page.

Foresight Results
screen, Stn &Tgt

09:06:06
Setup

Foresight Results

Stn & Tgt | Coordinates

Station ID: 1

Instrument Ht: m

Foresight ID: 2

Target Height: m

Target Type: 4.5" Target with Offset

Horiz Dist: 2.2825 m

Ready

Cont | Info | View | Page

Field	Description
Station ID	Station ID of current station.
Instrument Ht	Instrument height as entered.
Foresight ID	Target ID of the foresight target.
Target Height	Target height as entered.
Target Type	Target type of the foresight target.
Horiz Dist	Horizontal distance between station and foresight target.

Available commands:

Command	Function
Cont	Store the foresight results and proceed to the Scan Parameters screen.
Info	Show the target information of the foresight target.
View	View point cloud of foresight target scan.
Shift -> Redo	Repeat foresight target scan.
Page	Switch to the Coordinates page.

Foresight Results screen, Coordinates

09:07:25
Setup

Foresight Results

Stn & Tgt Coordinates

Foresight ID: 2
Northing: 1000.8500 m
Easting: 4997.8816 m
Height: 9.9903 m
Horiz Dist: 2.2825 m
Slope Dist: 2.2826 m
Azimuth: 291.864 deg

Ready

Cont Info View Page

Field	Description
Foresight ID	Target ID of the foresight target.
Northing	Northing coordinate of the foresight target.
Easting	Easting coordinate of the foresight target.
Height	Height of the foresight target.
Horiz Dist	Horizontal distance between station and foresight target.
Slope Dist	Slope distance between station and foresight target.

Field	Description
Azimuth	Azimuth from current station to foresight target.

Available commands:

Command	Function
Cont	Store the foresight results and proceed to the Scan Parameters screen.
Info	Show the target information of the foresight target.
View	View point cloud of foresight target scan.
Shift -> Redo	Repeat foresight target scan.
Page	Switch to the Stn &Tgt page.

8.6 Scanning and Imaging from a Traverse Station

Description

Once the foresight to the next station has been stored, the **Scan Parameters** screen for the current station will be accessed. Scanning, imaging and targeting can be executed as described in chapter "7.3 Scanning\Scan Parameters". Once data collection is completed, the instrument can be moved to the next station or the traverse can be closed.

Scan Parameters screen within Traverse workflow

The screenshot shows the 'Scan Parameters' screen for 'Traverse: Station-001'. The top status bar displays the time '10:56:46' and the word 'Scan'. Below the title bar, there are four tabs: 'Field of View', 'Resolution', 'Image Ctrl', and 'Filter'. The 'Field of View' tab is active, showing a dropdown menu set to 'Target All'. Below this, there are input fields for '90.000', '293.764', '293.764', and '-55.000'. The 'Task' dropdown is set to 'Scan only', and the 'Est Time' is '20 s'. At the bottom, there is a 'Ready' status bar with a dropdown arrow, and a row of buttons: 'Start', 'Target', 'Camera', 'Move', 'Close', and 'Page'.

10:56:46	Scan	Icons			
Traverse: Station-001					
Field of View	Resolution	Image Ctrl	Filter		
Field of View:	Target All				
	90.000				
Hz / V Area [°]	293.764	293.764			
	-55.000				
Task:	Scan only				
Est Time:	20 s				
Ready	Dropdown				
Start	Target	Camera	Move	Close	Page

Available commands:

Command	Function
Move / FS	Move to the next station after data collection on current station has been completed. Proceeds to the Define Backsight screen. Switches to FS in case the foresight measurement has been skipped or when the defined measurement sequence is BS-Data-FS . FS opens the Define Foresight screen.
Close / Abort	Close is active when last foresight target ID was a point with known coordinates. Opens the Closing Error page of the Traverse Results screen. Abort is shown as long as no foresight measurement has been done on the current station. Abort opens the Traverse Results screen.

8.7 Traverse Backsight

Define Backsight screen, Target Def

11:12:20
Setup

Define Backsight

Target Def Target List

Station ID: 2

Instrument Ht: m

Backsight ID: 1

Target Type: ▼

Target Height: m

Ready

Cont				PickT	Page
------	--	--	--	-------	------

Field	Description
Station ID	Station ID of current station.
Instrument Ht	Instrument height as entered.
Backsight ID	Target ID of the backsight target.
Target Type	Target type of the backsight target.

Field	Description
Target Height	Target height as entered.

Available commands:

Command	Function
Cont	Start backsight target scan. Show results in Known Backsight Results screen.
PickT	Select target from the video image. After selection, the target is listed on the Target List page.
Page	Switch to the Target List page.

Define Backsight screen, Target List

11:13:41
Setup

Define Backsight

Target Def Target List

Target ID	Type	Height	State
1	4.5" Target with	1.7200 m	-----

Ready

Cont					Page
------	--	--	--	--	------

Field	Description
Target ID	Shows the target ID of the backsight target.
Type	Shows the target type of the backsight target.
Height	Shows the target height of the backsight target.

Available commands:

Command	Function
Cont	Start backsight target scan. Show results in Known Backsight Results screen.
Page	Switch to the Target Def page.

Known Backsight Results screen, Stn & Tgt

11:22:51
Setup

Known Backsight Results

Stn & Tgt Delta Coordinates

Station ID: 2

Instrument Ht: m

Backsight ID: 1

Target Height: m

Target Type: 4.5" Target with Offset

Horiz Dist: 2.2816 m

Ready

Cont Info View Page

Field	Description
Station ID	Station ID of current station.
Instrument Ht	Instrument height as entered.
Backsight ID	Target ID of the backsight target.
Target Height	Target height as entered.
Target Type	Target type of the backsight target.
Horiz Dist	Horizontal distance between station and backsight target.

Available commands:

Command	Function
Cont	Store the backsight results and proceed to the Define Foresight screen.
Info	Show the target information of the backsight target.
View	View point cloud of backsight target scan.
Shift -> Redo	Repeat backsight target scan.
Page	Switch to the Delta page.

**Known Backsight
Results screen,
Delta**

11:24:56
Setup

Known Backsight Results

Stn & Tgt Delta Coordinates

Backsight ID: 1
 Δ Northing: 0.0000 m
 Δ Easting: -0.0001 m
 Δ Height: -0.0182 m
 Δ Horiz Dist: -0.0001 m

Ready

Cont Info View Page

Field	Description
Backsight ID	Target ID of the backsight target.
ΔNorthing	Difference in northing between calculated and measured coordinate.
ΔEasting	Difference in easting between calculated and measured coordinate.
ΔHeight	Difference in height between calculated and measured coordinate.

Field	Description
ΔHoriz Dist	Difference in horizontal distance between calculated and measured distance.

Available commands:

Command	Function
Cont	Store the backsight results and proceed to the Define Foresight screen.
Info	Show the target information of the backsight target.
View	View point cloud of backsight target scan.
Shift -> Redo	Repeat backsight target scan.
Page	Switch to the Coordinates page.

Known Backsight Results screen, Coordinates

11:26:08
Setup

Known Backsight Results

Stn & Tgt Delta Coordinates

Backsight ID: 1
Northing: 1000.0000 m
Easting: 4999.9999 m
Height: 9.9818 m
Horiz Dist: 2.2816 m
Slope Dist: 2.2816 m
Azimuth: 111.858 deg

Ready

Cont Info View Page

Field	Description
Backsight ID	Target ID of the backsight target.
Northing	Northing coordinate of the backsight target.
Easting	Easting coordinate of the backsight target.
Height	Height of the backsight target.
Horiz Dist	Horizontal distance between station and backsight target.
Slope Dist	Slope distance between station and backsight target.

Field	Description
Azimuth	Azimuth from current station to backsight target.

Available commands:

Command	Function
Cont	Store the backsight results and proceed to the Define Foresight screen.
Info	Show the target information of the backsight target.
View	View point cloud of backsight target scan.
Shift -> Redo	Repeat backsight target scan.
Page	Switch to the Stn & Tgt page.

8.8

Traverse Results

Description

In the **Traverse Results** screen the misclosure of a closed traverse is shown. Unadjusted coordinates of all stations and a graphical plot are provided.

Closing Error page

13:41:23
Traverse

Traverse-001: Traverse Results

Closing Error Points Plot

Status: Closed
Start Station: 1
Close Station: A
ΔNorthing: -0.0024 m
ΔEasting: 0.0009 m
ΔHeight: 0.0362 m
Angular Misclosure: 0.011 deg

Ready

Cont L + H Data Adjust Export Page

Field	Description
Status	The traverse status must be Closed to show its results.
Start Station	Name of the traverse start station.

Field	Description
Close Station	Name of the traverse close station.
ΔNorthing	Difference in northing between known and measured coordinate.
ΔEasting	Difference in easting between known and measured coordinate.
ΔHeight	Difference in height between known and measured coordinate.
Angular Misclosure	Angular misclosure of the closed traverse. Angular difference between calculated and measured closing angle.

Available commands:

Command	Function
Cont	Return to the Traverse Management screen.
L + H / N & E	Toggle between two modes of traverse misclosure display: <ul style="list-style-type: none">• L + H: traverse misclosure display in length and height.• N & E: traverse misclosure display in northing and easting.
Data	Open the Traverse Data screen to see a summary of all traverse station IDs, backsight IDs, foresight IDs and a plot of the traverse.

Command	Function
Adjust / UnAdj	Toggle between the display of unadjusted and adjusted results of the traverse (Traverse Results screen and Adjustment Results screen).
Export	Export the traverse stations and side shots to CSV file. Only active when USB memory device is attached.
Page	Switch to the Points page.

Points page

13:43:14
Traverse

Traverse-001: Traverse Results

Closing Error Points Plot

Point ID	Northing	Easting	Height
1	1000.0000	5000.0000	10.0000
2	1000.8495	4997.8823	9.9903
3	1004.9046	4998.3152	9.9773
A	1003.9416	5000.0000	9.9854
300	998.6930	5000.6970	12.2982
400	999.3408	4998.2407	11.5930
500	1001.3908	4995.0870	11.6720

Ready

Cont Data Adjust Export Page

Field	Description
Point ID	Name of the traverse station.
Northing	Northing of the traverse station.
Easting	Easting of the traverse station.
Height	Height of the traverse station.

Available commands:

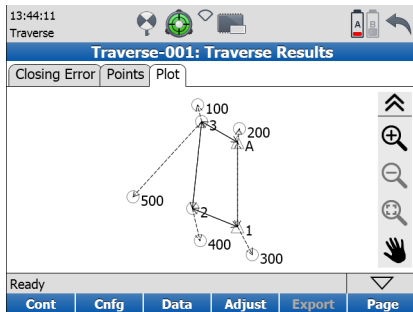

Command	Function
Cont	Return to the Traverse Management screen.
Data	Open the Traverse Data screen to see a summary of all traverse station IDs, backsight IDs, foresight IDs and a plot of the traverse.
Adjust	Proceed to the Closure page of the Adjustment Results screen to see adjusted results of the traverse.
Export	Export the traverse stations and side shots to CSV file. Only active when USB memory device is attached.
Page	Switch to the Plot page.

Plot page



Available commands:

Command		Function
Zoom In		Zoom in to the centre of the plot.
Zoom Out		Zoom out from the centre of the plot.
Zoom 1:1		Zoom back to fit complete plot to screen.

Command	Function
Pan  	Pan mode to move current traverse plot on screen. In activated mode the icon turns green.
Cont	Return to the Traverse Management screen.
Cnfg	Open the Plot page of the Traverse Configuration screen to define the visibility of plot elements.
Data	Open the Traverse Data screen to see a summary of all traverse station IDs, backsight IDs, foresight IDs and a plot of the traverse.
Adjust	Proceed to the Closure page of the Adjustment Results screen to see adjusted results of the traverse.
Export	Export the traverse stations and side shots to CSV file. Only active when USB memory device is attached.
Page	Switch to the Closing Error page.

8.9

Adjustment Results

Description

In the **Adjustment Results** screen the results of an adjusted traverse are shown. Adjusted coordinates of all stations and a graphical plot are provided.

Closure page

14:20:18
Traverse

Traverse-001: Adjustment Results

Closure Points Plot

Status: Adjusted
Start Station: 1
Close Station: A
ΔNorthing: 0.0000 m
ΔEasting: 0.0000 m
ΔHeight: 0.0000 m

Ready

Cont L + H UnAdj Export Page

Field	Description
Status	The traverse status must be Adjusted to show adjusted results.
Start Station	Name of the traverse start station.

Field	Description
Close Station	Name of the traverse close station.
ΔNorthing	ΔNorthing must be 0 for an adjusted traverse.
ΔEasting	ΔEasting must be 0 for an adjusted traverse.
ΔHeight	ΔHeight must be 0 for an adjusted traverse.

Available commands:

Command	Function
Cont	Return to the Main Menu .
L + H / N & E	Toggle between two modes of traverse misclosure display: <ul style="list-style-type: none"> • L + H: traverse misclosure display in length and height. • N & E: traverse misclosure display in northing and easting.  The misclosure must be 0 for an adjusted traverse.
UnAdj	Toggle between the display of unadjusted and adjusted results of the traverse (Traverse Results screen and Adjustment Results screen).
Export	Export the adjusted traverse stations and side shots to CSV file. Only active when USB memory device is attached.

Command	Function
Page	Switch to the Points page.

Points page

14:27:23
Traverse

Traverse-001: Adjustment Results

Closure Points Plot

Point ID	Northing	Easting	Height
1	1000.0000	5000.0000	10.0000
2	1000.8494	4997.8826	9.9937
3	1004.9039	4998.3161	9.9866
A	1003.9422	4999.9997	9.9791
300	998.6930	5000.6970	12.2982
400	999.3407	4998.2410	11.5963
500	1001.3901	4995.0879	11.6813

Ready

Cont UnAdj Export Page

Field	Description
Point ID	Name of the traverse station.
Northing	Adjusted northing of the traverse station.
Easting	Adjusted easting of the traverse station.

Field	Description
Height	Adjusted height of the traverse station.

Available commands:

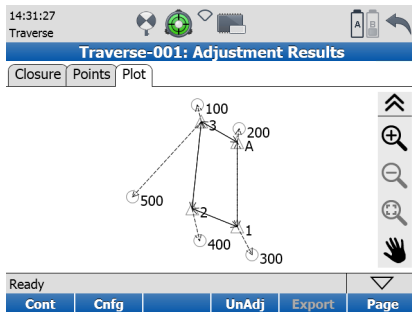

Command	Function
Cont	Return to the Main Menu .
UnAdj	Open the Closing Error page of the Traverse Results screen to see unadjusted results of the traverse.
Export	Export the adjusted traverse stations and side shots to CSV file. Only active when USB memory device is attached.
Page	Switch to the Plot page.

Plot page



Available commands:

Command		Function
Zoom In		Zoom in to the centre of the plot.
Zoom Out		Zoom out from the centre of the plot.
Zoom 1:1		Zoom back to fit complete plot to screen.

Command	Function
Pan  	Pan mode to move current traverse plot on screen. In activated mode the icon turns green.
Cont	Return to the Main Menu .
Cnfg	Open the Plot page of the Traverse Configuration screen to define the visibility of plot elements.
UnAdj	Open the Closing Error page of the Traverse Results screen to see unadjusted results of the traverse.
Export	Export the adjusted traverse stations and side shots to CSV file. Only active when USB memory device is attached.
Page	Switch to the Closure page.

9

Manage



Access

Select **Main Menu, Manage**  .

Description

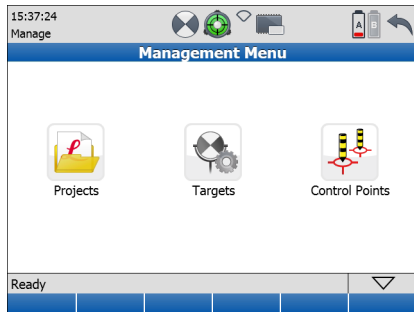
In the **Manage** menu all commands for project, target and control point management on the scanner are available.

Management Menu

Icon	Function
Projects 	Offers access to all commands for project management.
Targets 	Offers access to all commands for target management.
Control Points 	Offers access to all commands for control point management.

9.1 Manage\Projects

Access

Select **Main Menu, Manage**  , **Projects**  .

Description

In the **Manage, Projects** menu all commands for project management are available.

Manage Projects screen

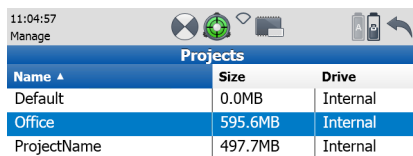

Name ▲	Size	Drive
Default	0.0MB	Internal
Office	595.6MB	Internal
ProjectName	497.7MB	Internal



Ready	▽				
Cont	New	Edit	Del	Data	

Field	Description
Name	Unique name of the project.
Size	File size (in MB) of the project.
Drive	Storage device: Internal or USB device.

Available commands:

Command	Function
Cont	Confirm selection and return to previous screen.
New	Create new project with project name, description, name of creator and storage device.
Edit	Edit description and creator of selected project. Also show name, date and size of existing project.
Del	Selected project will be deleted after confirmation.
Data	Show data details of selected project such as station name, scan name, scan view, target ID, target type and target view.
Shift -> Scale	Open the Scale Factor screen to define atmospheric and geometric corrections.

Command	Function
Shift -> Trans	Transfer selected project or all projects to a USB memory storage device or to scanner's hard disk.

9.1.1

Manage\Projects\New Project

Access

Select **Main Menu**, **Manage**  , **Projects**  , **New**.

Description

In the **New Project** screen a new project with details such as name, description, creator and storage device can be created.

New Project screen

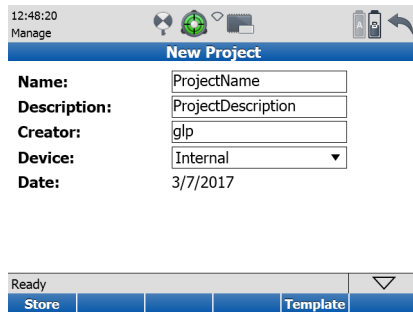

The screenshot shows the 'New Project' screen. At the top, there is a status bar with the time '12:48:20' and the word 'Manage'. Below this is a navigation bar with the title 'New Project'. The main area contains several input fields:

Name:	<input type="text" value="ProjectName"/>
Description:	<input type="text" value="ProjectDescription"/>
Creator:	<input type="text" value="glp"/>
Device:	<input type="text" value="Internal"/>
Date:	<input type="text" value="3/7/2017"/>

At the bottom, there is a navigation bar with the word 'Ready' and a dropdown arrow. Below this are several buttons, including 'Store' and 'Template'.



For new projects the atmospheric and the geometric PPM are always set to **0.0000**.

Field	Description
Name	Enter a unique project name. The name may be up to 14 characters long and may include letters such as A-Z, a-z, numbers from 0-9 and the special characters "-" and "_".
Description	Enter a short description of the project. Input is optional.
Creator	The person's name/abbreviation who is creating the scan project. Input is optional.
Device	Select the data storage device. Internal saves scan data on the internal SSD, USB Device stores scan data on an external USB storage device.
Date	Date of creation. Appears automatically and cannot be edited.

Available commands:

Command	Function
Store	Store the new project with description, creator and date and return to the Manage Projects screen.
Template	Open the Project Name Template screen to define a name template for new projects.

Project Name Template screen

12:51:12
Config

Project Name Template

Template:

Name Template:

Ready

Cont

Field	Option	Description
Template	None	No project name template is used and the Name Template field is deactivated and empty.
	Date and Time	Project name is encoded with date and time in the format yy-mm-dd_hh-mm-ss, for example 17-03-07_01-02-45. The Name Template field is deactivated but shows the current project name.
	Custom	A user-defined project name template can be entered in the Name Template field. The project name is incremented by one for each new project.
Name Template		Shows the selected name template.

Available commands:

Command	Function
Cont	Store the project name template and return to the New Project screen.



When all projects are deleted with the **Format** command, a new project with the name **Default** is generated automatically if the **Template** type is set to **None**. Otherwise a project name according to the active **Template** type (**Date and Time** or **Custom**) is generated.

Field	Description
Name	Name of selected project.
Description	Edit/add project description.
Creator	Edit/add creator details.
Device	Storage device. Not editable.
Date	Creation date of selected project. Not editable.

Available commands:

Command	Function
Store	Store new information and return to the Manage Projects screen.
Template	Open the Project Name Template screen to define a name template for new projects.

9.1.3

Manage\Projects\Delete Project

Access

Select **Main Menu**, **Manage**  , **Projects**  , **Del.**

Description

In the **Delete Project** screen an existing project can be deleted.

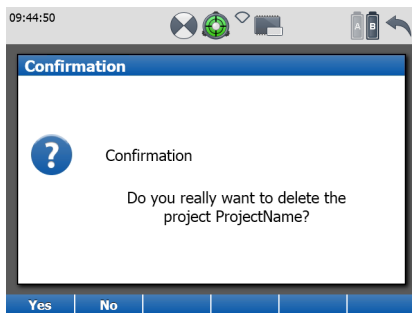
**Confirmation
message**

Option	Description
Yes	Confirm deletion of the selected project.  A deleted project cannot be restored.
No	Decline deletion of the selected project.

9.1.4

Manage\Projects\Data

Access

Select **Main Menu**, **Manage** , **Projects** , **Data**.

Description

In the **Project Data** screen details of data are available such as station name, scan name, target ID, target type, target coordinates and traverse information. Point clouds of scans and target scans can be viewed.

Station / ScanWorld page

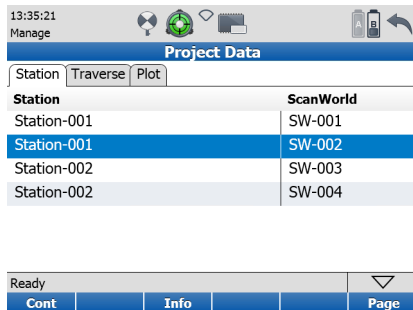

Station	ScanWorld
Station-001	SW-001
Station-001	SW-002
Station-002	SW-003
Station-002	SW-004

Ready

Cont	Info	Page
------	------	------

Field	Description
Station	List of available stations in the selected project.
ScanWorld	Name of the ScanWorld. A ScanWorld is created for each new Setup. Scans and images that belong to the same coordinate system are combined in a ScanWorld. Several ScanWorlds can belong to the same station.

Available commands:

Command	Function
Cont	Confirm station selection and continue to Manage Data screen.
Info	Open Station Information for details about selected station.
Page	Switch to the Traverse page.

Traverse page

14:09:19
Manage

Project Data

Station Traverse Plot

Traverse ID ▲	No of Stn	Status
Traverse-001	0	Open
Traverse-002	5	Adjusted
Traverse-003	4	Closed

Ready

Cont			Results	Page
------	--	--	---------	------

Field	Description
Traverse ID	List of all traverses stored in the project.
No of Stn	Number of stations in a traverse.
Status	Status of a traverse: Open , Closed or Adjusted .

Available commands:

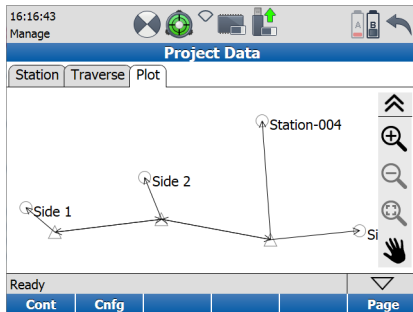

Command	Function
Cont	Open the Traverse Data menu.
Results	Results is active when the status of the selected traverse is Closed or Adjusted . Opens the Traverse Results screen or the Adjustment Results screen. Close is active when the status of the selected traverse is Open . Opens the Traverse Results screen.
Page	Switch to the Plot page.

Plot page



Available commands:

Command		Function
Zoom In		Zoom in to the centre of the plot.
Zoom Out		Zoom out from the centre of the plot.
Zoom 1:1		Zoom back to fit complete plot to screen.

Command	Function
Pan  	Pan mode to move current traverse plot on screen. In activated mode the icon turns green.
Cont	Return to the Manage Projects screen.
Cnfg	Open the Project Plot Configuration screen to define the visibility of plot elements.
Page	Switch to the Station page.

Project Plot Configuration screen

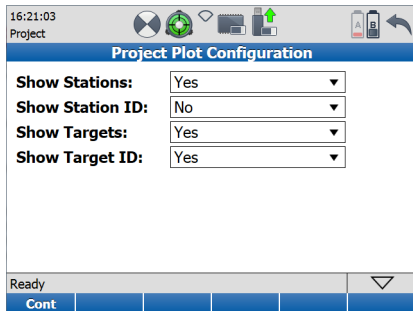

16:21:03
Project

Project Plot Configuration

Show Stations: Yes ▼

Show Station ID: No ▼

Show Targets: Yes ▼

Show Target ID: Yes ▼

Ready

Cont

Field	Description
Show Station	Display or hide all station symbols on the Plot page.
Show Station ID	Display or hide all station IDs on the Plot page.
Show Targets	Display or hide all target symbols on the Plot page.
Show Target ID	Display or hide all target IDs on the Plot page.

Available commands:

Command	Function
Cont	Return to the Plot page in the Project Data screen.

Scans page

14:19:21
Manage

Data

All Data Scans Images Targets

Scan ▲	Resolution	Sensitivity	No of Point
Scan-1	50.0mm@10m	Normal	1276 x 47.
Scan-2	25.0mm@10m	High	199 x 227
Scan-3	12.5mm@10m	High	180 x 211
Scan-4	5.0mm@1.6m	Normal	124 x 117
Scan-5	2.0mm@5.7m	High	562 x 507

Ready

View Page

Field	Description
Scan	All scans from the selected station are listed.
Resolution	Resolution setting of selected scan.
Sensitivity	Sensitivity setting of selected scan (ScanStation P40 only).
No of Points	Number of points in the selected scan in horizontal and vertical direction.

Available commands:

Command	Function
View	View the point cloud of the selected scan.
Page	Switch to the Images page.

Images page

The screenshot shows the 'Manage' interface for the ScanStation P40/P30. At the top left, the time is 13:43:38. The 'Data' section is active, with tabs for 'All Data', 'Scans', 'Images', and 'Targets'. Below the tabs is a table with two columns: 'Name' and 'No of Files'. The table contains one entry: 'Image-1' with 85 files.

Name	No of Files
Image-1	85

The screenshot shows the 'Ready' status bar. On the left, the word 'Ready' is displayed. On the right, there is a dropdown arrow icon. Below the status bar are two buttons: 'View' and 'Page'.

Field	Description
Name	Name of the image set.







Field	Description
No of Files	Number of images included in the image set.

Available commands:

Command	Function
View	Open image viewer to display the selected image.
Page	Switch to the Targets page.

Targets page

12:34:17
Manage

Data

All Data Scans Images **Targets**

Target ID	Target Type	State
S1	HDS Sphere	OK
T-1	B/W Target 3"	OK
t45	B/W Target 6"	OK
123	Leica B/W 4.5"	OK

Ready 

View **Dist** **Info** **Edit** **Page**

Field	Description
Target ID	List of all targets that have been acquired on the selected station.
Target Type	The target's associated target type.
State	Status of scanned target. OK indicates a successful acquisition of the target centre. A bad target centre acquisition is marked as BAD .

Available commands:

Command	Function
View	View point cloud of the selected target scan.
Dist	Open Distance between Targets screen to compute slope distance between two targets.
Info	Show target results of the selected target such as target ID, target type, northing, easting, height and distance from scanner. Coordinates and distances refer to the target base point. For details about the target results refer to chapter "7.3.7 Scanning\Scan Parameters\...\Target Definition".
Edit	Open the Edit Target Results screen to alter Target ID and Target Height .
Page	Switch to the All Data page.

9.1.5

Manage\Projects\Transfer Project

Access



Select **Main Menu**, **Manage**  , **Projects**  , **Shift -> Trans.**

Description

In the **Transfer** screen projects can be transferred from the scanner's hard disc to an external USB memory storage device and vice versa.
Refer to chapter "12.2 Tools\Transfer" for more information.

9.2 Manage\Targets

Access

Select **Main Menu, Manage**  , **Targets** 

Description

In the **Manage, Targets** menu all commands for target management on the scanner are available.

Manage Targets screen

12:36:29
Manage

Targets	
Name ▲	Type
Leica B/W 4.5"	B/W Target 4.5"
B/W Target 6"	B/W Target 6"
B/W Target 3"	B/W Target 3"
HDS Sphere	Sphere

Ready

Cont	New	Edit	Del	More	▼
------	-----	------	-----	------	---

Field	Option	Description
Name	-	Unique name of the target.
Type	Sphere	Spherical target.
	B/W Target 6"	HDS 6" Black&White circular planar target.
	Leica B/W 4.5"	Leica 4.5" Black&White circular target.
	B/W Target 3"	HDS 3" Black&White target.
Class	System	Default target type provided by the system.
	User	User-defined target type.

Available commands:

Command	Function
Cont	Confirm selection and return to previous screen.
New	Create new target of class User with target name, target type, diameter, height offset and default target height.

Command	Function
Edit	Edit name, target type, diameter, height offset and default target height of a user-defined target. System targets cannot be edited.
Del	Selected target will be deleted after confirmation.
More	Shift between Type and Class in the target list.
Shift -> Deflt	Restore all deleted System targets. User targets cannot be restored.

9.2.1

Manage\Targets\New Target

Access







Select **Main Menu**, **Manage** , **Targets** , **New**

Description

In the **New Target** menu a new target with details such as name, target type, diameter, height offset and target height can be created.

New Target page

08:19:45
Manage

New Target

Name:	<input grt14"="" on="" type="text" value="Leica B/W 4.5"/>
Target Type:	<input data-bbox="575 502 793 533" type="text" value="B/W Target 4.5"/>
Diameter:	<input type="text" value="0.1143"/> m
Height Offset:	<input type="text" value="0.0155"/> m
Target Height:	<input type="text" value="1.6540"/> m

Ready 

Store

Field	Description
Name	Enter a unique target name. The name may be up to 16 characters long and may include letters such as A-Z, a-z, numbers from 0 -9 and the special characters "-" and "_".
Target Type	Enter the target type from a drop-down list.
Diameter	Enter the target diameter for a spherical target.
Height Offset	Enter a fixed height offset which is added to the target height. Input optional.
Target Height	Enter the default target height. Input optional.

Available commands:

Command	Function
Store	Store new target with name, target type, diameter, height offset and default target height on the scanner's hard disk and return to the Manage Target menu.

9.2.2

Manage\Targets\Edit Target

Access

Select **Main Menu**, **Manage** , **Targets** , **Edit**.

Description

In the **Edit Target** menu the target type, diameter, height offset and target height of an existing target can be changed.

Edit Target page

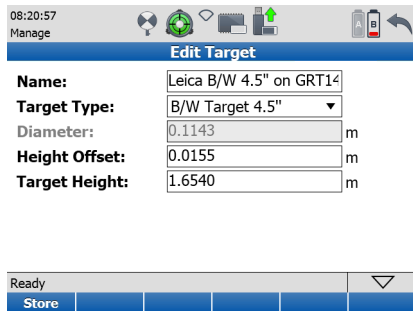

08:20:57
Manage

Edit Target

Name: Leica B/W 4.5" on GRT14

Target Type: B/W Target 4.5" ▼

Diameter: 0.1143 m

Height Offset: 0.0155 m

Target Height: 1.6540 m

Ready

Store

Field	Description
Name	Name of the selected target.
Target Type	Enter the target type from a drop-down list.
Diameter	Edit/add the target diameter for a spherical target.
Height Offset	Edit/add the fixed height offset which is added to the target height.
Target Height	Edit/add the default target height.

Available commands:

Command	Function
Store	Store new information and return to the Manage Targets menu.

9.2.3

Manage\Targets\Delete Target

Access

Select **Main Menu**, **Manage**  , **Targets**  , **Del.**

Description

In the **Delete Target** menu an existing target can be deleted from the target list.

Confirmation message

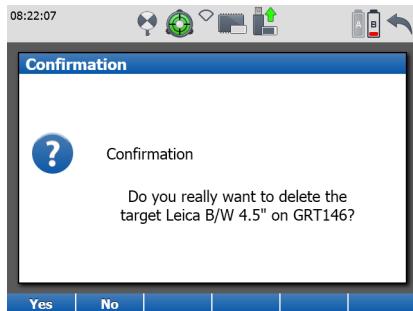

Option	Description
Yes	Confirm the deletion of the selected target.  A deleted system target can be restored by Shift -> Deflt . A deleted user target cannot be restored.
No	Decline deletion of the selected target.

9.3

Manage\Control Points

Access

Select **Main Menu, Manage** , **Control Points**  .

Description

In the **Manage, Control Points** menu all commands for control points management are available.

Projects screen

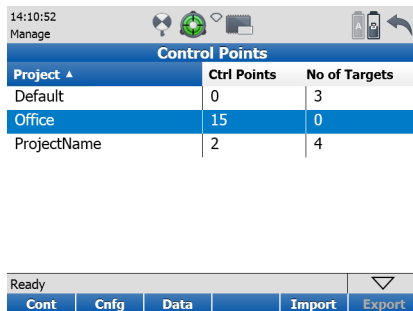

14:10:52
Manage

Control Points		
Project ▲	Ctrl Points	No of Targets
Default	0	3
Office	15	0
ProjectName	2	4

Ready

Cont	Cnfg	Data	Import	Export
------	------	------	--------	--------

Field	Description
Name	Unique name of the project.
Ctrl Points	Number of control points included in the project.
No of Targets	Number of targets included in the project.

Available commands:

Command	Function
Cont	Confirm selection and return to previous screen.
Cnfg	Open Export Control Point Settings screen to include or exclude targets at export of control points.
Data	Open the Control Points list with a list of all control points of the selected project and commands to create, edit, delete or import control points.
Import	Open Import Control Points screen to import control points from ASCII file.
Export	Export control points and targets to CSV file. Only active when USB memory device is attached.

Configure Control Point Export screen



Field	Description
Include Targets	Include/exclude targets from control point export to USB device.

Available commands:

Command	Function
Cont	Confirm and return to the Control Points menu.

9.3.1 Manage\Control Points\Import Control Points

Access

Select **Main Menu**, **Manage** , **Control Points** , **Import**.

Description

In the **Import Control Points** screen an external ASCII file can be selected for control point import. The import parameters can be defined in the **Define ASCII Import** screen.

Import Control Points screen

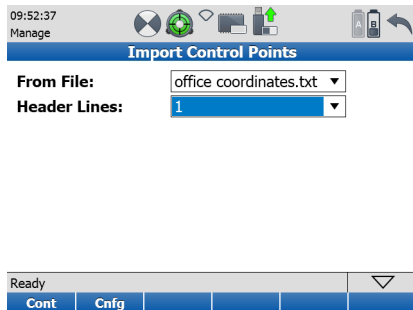

09:52:37
Manage

Import Control Points

From File: office coordinates.txt ▾

Header Lines: 1 ▾

Ready ▾

Cont Cnfg

Field	Description
From File	Select the ASCII file containing the control points to be imported.
Header Lines	Select the number of lines in the ASCII file to be skipped at import.



The ASCII file must be located in the main directory of the connected USB device. No particular file extension is required.

Available commands:

Command	Function
Cont	Confirm and import the control points from the selected file.
Cnfg	Open the Define ASCII Import screen to adjust import settings.

Define ASCII Import screen

15:42:41
Manage

Define ASCII Import

Delimiter: Tab ▼

Point ID Pos: 1 ▼

Northing Pos: 3 ▼

Easting Pos: 2 ▼

Height Pos: 4 ▼

Example: P E N H

Ready

Cont Deflt

Field	Description
Delimiter	Select the delimiting character used to separate one column from the next in the ASCII file (Semicolon, Comma, Space, Tab).
Point ID Pos	Select the position of the column which contains the point ID information.
Northing Pos	Select the position of the column which contains the Northing information.

Field	Description
Easting Pos	Select the position of the column which contains the Easting information.
Height Pos	Select the position of the column which contains the Height information.
Example	Shows example of selected import settings (e.g. P;E;N;H).

Available commands:

Command	Function
Cont	Confirm and return to the Import Control Points screen.
Deflt	Reset to default import settings (P,E,N,H).

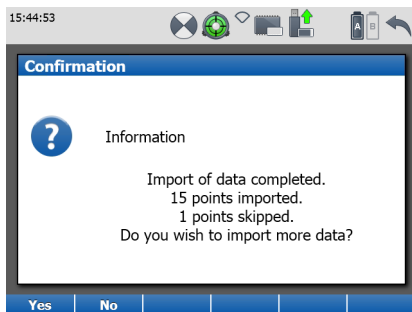
**Confirmation
message**

Option	Description
Yes	Confirm and return to Import Control Points screen to import more data.
No	Decline import of more data and return to Projects screen.

9.3.2

Manage\Control Points\Data

Access

Select **Main Menu**, **Manage** , **Control Points** , **Data**.

Description

In the **Manage, Control Points** screen all control points of a selected project are listed. For detailed information about the different options and commands that can be executed from this page refer to the descriptions on the following pages.



Control Points	
Name ▲	Date
10	3/19/2013 ▲
11	3/19/2013
12	3/19/2013
13	3/19/2013
14	3/19/2013
15	3/19/2013
20	3/19/2013
21	3/19/2013 ▼

Ready

Cont New Edit Del Import

Field	Description
Name	Point ID of control point.
Date	Date of creation of control point.

Available commands:

Command	Function
Cont	Continue to Projects screen.
New	Create new control point with Point ID, Northing, Easting and Height.
Edit	Edit Northing, Easting or Height of selected control point. Also show Point ID of existing control point.
Del	Selected control point will be deleted after confirmation.
Import	Open Import Control Points screen to import control points from ASCII file.
Shift -> D-all	All control points of selected project will be deleted after confirmation.

9.3.3

Manage\Control Points\Data\New Control Point







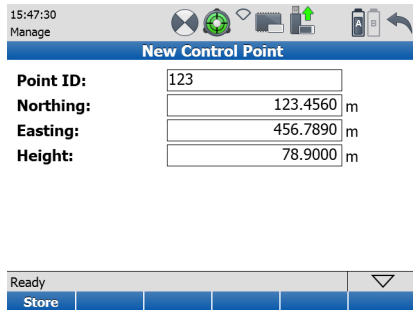

Access

Select **Main Menu**, **Manage** , **Control Points** , **Data**, **New**.

Description

In the **New Control Point** screen a new control point can be created by entering Point ID, Northing, Easting and Height.



15:47:30 Manage							
New Control Point							
Point ID:	<input type="text" value="123"/>						
Northing:	<input type="text" value="123.4560"/> m						
Easting:	<input type="text" value="456.7890"/> m						
Height:	<input type="text" value="78.9000"/> m						
Ready							
Store							

Field	Description
Point ID	Enter Point ID of new control point.
Northing	Enter Northing of new control point.
Easting	Enter Easting of new control point.
Height	Enter Height of new control point.

Available commands:

Command	Function
Store	Store new information and return to Control Points screen.

9.3.4

Manage\Control Points\Data\Edit Control Point

Access



Select **Main Menu**, **Manage** , **Control Points** , **Data**, **Edit**.

Description

In the **Edit Control Point** screen Northing, Easting and Height of the selected control point can be changed.

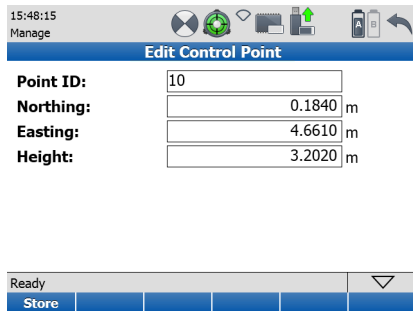
Edit Control Point screen



15:48:15 Manage	
Edit Control Point	
Point ID:	<input type="text" value="10"/>
Northing:	<input type="text" value="0.1840"/> m
Easting:	<input type="text" value="4.6610"/> m
Height:	<input type="text" value="3.2020"/> m
Ready	
Store	

Field	Description
Point ID	Point ID of selected control point.
Northing	Northing of selected control point.
Easting	Easting of selected control point.
Height	Height of selected control point.

Available commands:

Command	Function
Store	Store new information and return to Control Points screen.

9.3.5

Manage\Control Points\Data\Delete Control Point

Access

Select **Main Menu**, **Manage** , **Control Points** , **Data**, **Del.**

Description

In the **Delete Control Point** screen a selected control point can be deleted.

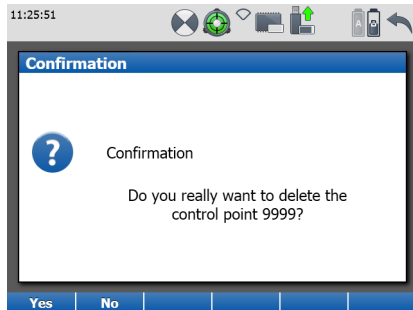

Confirmation message



Option	Description
Yes	Confirm deletion of selected control point.  A deleted control point cannot be restored.
No	Decline deletion of selected control point.

9.3.6 Manage\Control Points\Data\Import Control Points

Access

Select **Main Menu**, **Manage** , **Control Points** , **Data**, **Import**

Description

Refer to chapter "9.3.1 Manage\Control Points\Import Control Points".

9.3.7 Manage\Control Points\Data\Delete All Control Points

Access

Select **Main Menu**, **Manage** , **Control Points** , **Data**, **Shift -> D-all**.

Description

In the **Delete All Control Points** screen all control points of a project can be deleted.

Confirmation message

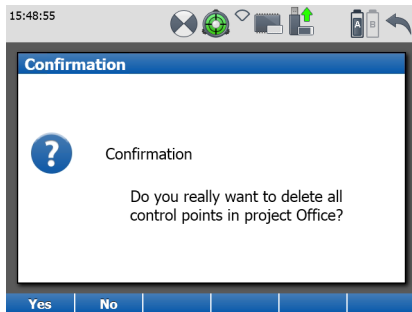

Option	Description
Yes	Confirm deletion of all control points in the selected project.  Deleted control points cannot be restored.
No	Decline deletion of all control points in the selected project.

10

Status

Access



Select **Main Menu, Status**  .

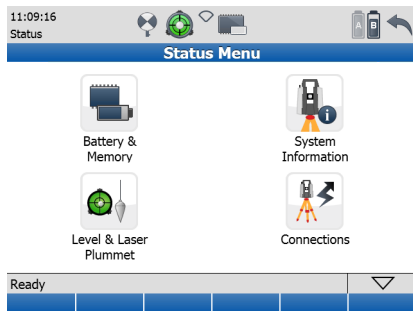

Description

The **Status Menu** provides general status information about different components of the scanner such as battery and memory, general system information, level and laser plummet and WiFi status information.

Status Menu screen



Icon	Command	Description
Battery & Memory 	Battery	Status information about internal battery, external battery and AC power supply.
	Memory	Status information about size and free space of internal hard disc's data partition and connected external USB device.
System Information 	Instrument	Status information about instrument type, serial number, equipment number and system language.
	Firmware	Status information about installed firmware version and firmware maintenance expiry date.
	Options	Status information about the installed data access option and the installed external camera option.
	Legal information	Copyright information about installed software.







Icon	Command	Description
Level & Laser Plummet 	Level	Numerical and graphical display of instrument's tilt.
	Plummet	Switch laser plummet on/off.
	Compensator	Switch dual-axis compensator on/off. Define how scanner should react when compensator goes out of range.
Connections 	WiFi	Status information about internal WiFi. Enable/disable the internal WiFi adaptor.

Available commands:

Command	Function
Shift -> Sync	Open the Synchronization screen.

Synchronization screen

13:29:19
Status

Synchronization Status

Baud Rate Sync Port: 4800

Synchronization: Not Synchronized

ZDA Message: Not Valid

Synch Counter: 0

Drift [ppm]: 0.000

Ready

Cont

Field	Description
Baud Rate Sync Port	Select a baud rate from 4800 to 115200 from the drop down list.
Synchronization	Shows synchronization status. Synchronized or Not Synchronized .
ZDA Message	Shows ZDA message status. Valid or Not Valid . In the message bar the last received ZDA message is displayed in the format \$GPZDA,hhmmss.ss,dd,mm,yyyy,xx,yy*CC

Available commands:

Command	Function
Cont	Store the synchronization parameters and return to the Status Menu .

10.1

Status\Battery & Memory

Access

- Select **Main Menu, Status** , **Battery & Memory**  .

OR

- Press one of the power icons  in the status bar to access the **Battery** page directly.

OR

- Press the memory icon  in the status bar to access the **Memory** page directly.

Description

In the **Status, Battery & Memory** screen detailed information about the scanner's battery and memory status can be obtained.

Battery page

11:49:05
Status

Battery & Memory

Battery Memory

Battery A: 99 %

Battery B: 39 %

Ext Battery: N/A

Ready

Cont Page

Field	Description
Battery A	Percentage of remaining power of battery A in compartment on scanner's front side (the side with touch screen).
Battery B	Percentage of remaining power of battery B in compartment on scanner's reverse side (the side without touch screen).
Ext Battery	Percentage of remaining power of external battery.



The battery status is also indicated by the power icons in the status bar. Refer to "3.3 Status Bar" for more information.

Available commands:

Command	Function
Cont	Return to previous menu.
Page	Switch to the Memory page.

Memory page

11:51:05
Status

Battery & Memory

Battery Memory

	Size / Free
Data:	199.22 / 190.42 GB
USB:	3.61 / 2.43 GB

Ready

Cont Page

Field	Option	Description
Data	Size	Total space for data storage on data partition of scanner's hard disc.
	Free	Free space for data storage on data partition of scanner's hard disc.
USB	Size	Total space for data storage on external USB device.
	Free	Free space for data storage on external USB device.

Available commands:

Command	Function
Cont	Return to previous menu.
Page	Switch to the Battery page.

10.2

Status\System Information

Access

Select **Main Menu**, **Status** , **System Information**  .

Description

The **System Information** screen provides detailed information about instrument type, serial number, system language and firmware version.

Instrument page

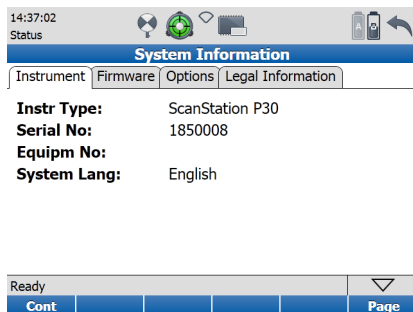

14:37:02
Status

System Information

Instrument Firmware Options Legal Information

Instr Type: ScanStation P30
Serial No: 1850008
Equipm No:
System Lang: English

Ready

Cont Page

Field	Description
Instr Type	Instrument type.
Serial No	Serial number of the instrument. See also serial number plate on instrument's bottom side.
Equipm No	Leica unique identification code of the instrument.
System Lang	Active system language.

Available commands:

Command	Function
Cont	Return to Status Menu .
Page	Switch to the Firmware page.

Firmware page

13:31:22
Status

System Information

Instrument Firmware Options Legal Information

Firmware: 2.70.441
Maint End: 10/31/2017 12:00:00 AM

Ready

Cont Page

Field	Description
Firmware	Firmware version of the installed onboard software.
Maint End	Expiry date of firmware maintenance period. All firmware versions with release date prior to this date can be uploaded.

Available commands:

Command	Function
Cont	Return to Status Menu .
Page	Switch to the Options page.

Options page

14:40:05
Status

System Information

Instrument Firmware Options Legal Information

API Data Access: Activated
Ext. Camera: Activated

Ready

Cont Page

Field	Description
API Data Access	Access to scan data via Application Programming Interface (API) activated or deactivated.
Ext. Camera	Status of the external camera option: activated or deactivated.

Available commands:

Command	Function
Cont	Return to Status Menu .
Page	Switch to the Legal Information page.
Shift -> Del	Delete installed options.

Legal Information page

14:41:03
Status

System Information

Instrument Firmware Options Legal Information

**This software contains copyrighted software. Press
Details to list according copyright statements.**

Ready

Cont	Details				Page
------	---------	--	--	--	------

Available commands:

Command	Function
Cont	Return to Status Menu .
Details	List copyright statements.
Page	Switch to the Instrument page.

10.3

Status\Level & Laser Plummet

Access

- Select **Main Menu, Status**  , **Level & Laser Plummet**  .

OR

- Press the compensator icon  in the status bar to access the **Level** page directly.

Description

The **Level & Laser Plummet** screen provides detailed information about the electronic level, the laser plummet and the compensator settings.

Level page

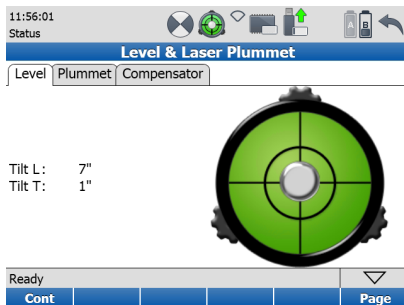

11:56:01
Status

Level & Laser Plummet



Level Plummet Compensator

Tilt L: 7"
Tilt T: 1"

Ready

Cont Page

Field	Option	Description
Tilt L	-	Longitudinal tilt of the vertical axis.
Tilt T	-	Transversal tilt of the vertical axis.
Bubble Level	green	Tilt L and Tilt T < 5': level is within the high accuracy working range of the compensator. The accuracy of the compensator in the $\pm 5'$ working range is 1.5".
	red	Tilt L or Tilt T > 5': level is out of the high accuracy working range of the compensator.

As soon as the bubble level colour changes from green (within compensator range) to red (outside of $\pm 5'$ compensator range) the compensator icon in the status bar changes from  to .

The level moves linearly with the inclination values **Tilt L** and **Tilt T**. It moves down if the value in **Tilt L** increases and vice versa. It moves left if the value in Tilt T gets bigger and vice versa.



Align the scanner side cover with the touch screen parallel to two of the tribrach footscrews. Rotating these two footscrews then causes the bubble to move only left/right. Rotating the third footscrew causes the bubble to move only up/down.

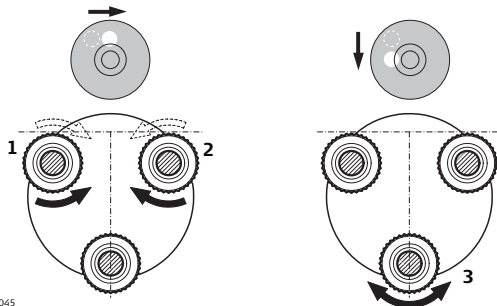

P20 045

Available commands:

Command	Function
Cont	Return to previous menu.
Page	Switch to the Plummet page.

Plummet page

11:57:00
Status

Level & Laser Plummet

Level Plummet Compensator

Laser Plummet: On ▾

Intensity: 100 ▾ %

Ready ▾

Cont Page

Field	Option	Description
Laser Plummet	On	Turn the red laser plummet on.
	Off	Turn the red laser plummet off.
Intensity	-	Set the laser plummet intensity by increments of 20%.

By default the laser plummet is **Off** after system boot.

Changing this setting to **On** turns the laser plummet on immediately. It is only visible when the **Level & Laser Plummet** screen is active.

Available commands:

Command	Function
Cont	Return to previous menu.
Page	Switch to the Compensator page.

Compensator page

The screenshot shows the 'Level & Laser Plummet' screen. At the top, there is a status bar with the time '13:11:22', the word 'Status', and several icons including a level bubble, a green laser symbol, a Wi-Fi icon, a battery icon, and a back arrow. Below the status bar is a blue header with the text 'Level & Laser Plummet'. Underneath the header are three tabs: 'Level', 'Plummet', and 'Compensator', with 'Compensator' being the active tab. The main content area contains two settings: 'Compensator:' with a dropdown menu set to 'On', and 'Out of Range:' with a dropdown menu set to 'Flag Data & Cont'. At the bottom of the screen, there is a 'Ready' status bar with a dropdown arrow on the right. Below this bar is a row of five blue buttons: 'Cont', three unlabeled buttons, and 'Page'.

Field	Option	Description
Compensator	On	Turns the compensator on.
	Off	Turns the compensator off temporarily. After system restart, the compensator will be on again.
	Always Off	Turns the compensator off. After system restart, the compensator will remain off.
Out of Range	Cancel Scan&Img	If the compensator goes out of range, cancel the current scan or image acquisition.
	Flag data & Cont	If the compensator goes out of range, continue current scan or image acquisition, but flag unlevelled object for subsequent data import.

By default the compensator is **On** after system boot.

When changing this setting to **Off** or **Always Off** the compensator icon in the status

bar changes to .

Available commands:

Command	Function
Cont	Return to previous menu.

Command	Function
Page	Switch to the Level page.

10.4

Status\WiFi

Access

Select **Main Menu**, **Status** , **Connections**  .

Description

In the **Connections** screen the communication parameters of the internal WiFi device can be defined. Depending on the remote control device the WiFi connection mode and a key for encryption can be set.

WiFi page

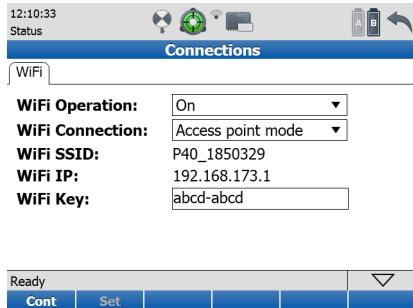

The screenshot shows the WiFi configuration page. At the top, the time is 12:10:33 and the status is 'Status'. The page title is 'Connections'. Below the title, there is a 'WiFi' tab. The configuration fields are:

WiFi Operation:	On
WiFi Connection:	Access point mode
WiFi SSID:	P40_1850329
WiFi IP:	192.168.173.1
WiFi Key:	abcd-abcd

At the bottom, there is a 'Ready' status bar with a dropdown arrow and a navigation bar with 'Cont' and 'Set' buttons.

Field	Option	Description
WiFi Operation	On	Switches the internal WiFi board on, off or always on.
	Off	
	Always on	
WiFi Connection	Access point mode	Select the WiFi connection mode.
	Ad-hoc mode	
WiFi SSID	-	The scanner's Service Set Identifier (SSID) shown in the list of available network connections. The name is P30_185xxx with 185xxx being the scanner's serial number.
WiFi IP	-	The scanner's WiFi IP address. In Access point mode the general WiFi IP address for all scanners is 192.168.173.1. In Ad-hoc mode the WiFi IP address differs for each scanner.
WiFi Key	-	Password for WiFi encryption. The default key is "abcd-abcd" and can be changed to any other password with 8 or more characters.

Available commands:

Command	Function
Cont	Return to the Status Menu .
Set	Apply changes of the WiFi or Bluetooth configuration.

11 Configuration

Access





Select **Main Menu, Configuration**  .

Description

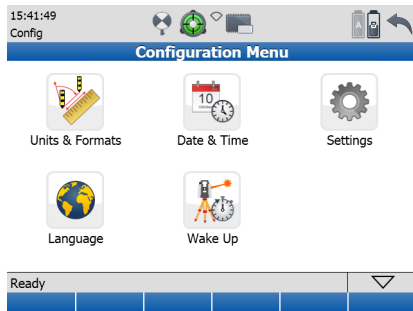
In the **Configuration Menu** the **Units & Formats**, the local **Date & Time**, the general **Settings**, the **MMI Language** and the **Wake Up** session can be configured.

Configuration Menu screen



Icon	Command	Description
Units & Formats 	Distance Unit	Select unit for distances (Metre, Int Ft, Us Ft).
	Distance Dec	Select number of decimal digits for distance display.
	Temperature	Select unit for temperature (°C, °F).
	Pressure	Select unit for pressure (mbar, Inch Hg).
Date & Time 	Local Time	Set local time.
	Local Date	Set local date.
Settings 	-	Define settings for handle check, scan viewer behaviour, fan cooling, guiding beam and boot-up behaviour.
Language 	Language	Select language for the user interface or delete a language from the list.
Wake Up 	-	Define Wake up session for automatic and repeated data acquisition.

11.1 Configuration\Units & Formats

Access Select **Main Menu, Configuration**  , **Units & Formats**  .

Description In the **Units & Formats** screen linear units, the number of decimals and the units for temperature and pressure can be defined.

Units & Formats
screen

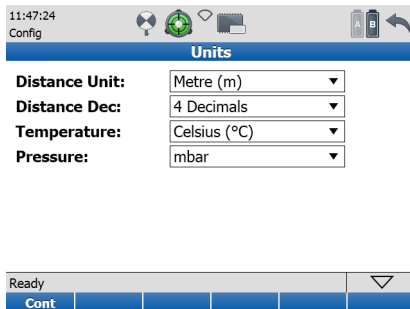

11:47:24
Config

Units

Distance Unit:	Metre (m) ▼
Distance Dec:	4 Decimals ▼
Temperature:	Celsius (°C) ▼
Pressure:	mbar ▼

Ready

Cont

Field	Option	Description
Distance Unit	Metre (m)	Metre: Uses SI base unit metre.
	Int Ft (fi)	International feet: Uses 1 ft = 1' = 12 in. = 1/3 yd = 30.48 cm
	US Ft (ft)	U.S. survey feet: Uses 39,37 in. = 1 m (1 U.S. survey foot = 1200/3937 m equates approximately 30.48006 cm)
Distance Dec	0 to 4 Decimals	Number of decimal digits for distance related fields.
Temperature	Celsius (°C)	Uses °Celsius: $^{\circ}\text{C} = (^{\circ}\text{F} - 32) \times 5/9$
	Fahrenheit (°F)	Uses °Fahrenheit: $^{\circ}\text{F} = ^{\circ}\text{C} \times 1.8 + 32$
Pressure	mbar	Uses Millibar: 1000 mbar = 1 bar = 29.5299801647 inHg
	Inch Hg (inHg)	Uses Inch of Mercury: 1 inHg = 33.86389 mbar

Available commands:

Command	Function
Cont	Confirm and return to the Configuration Menu .

11.2

Configuration\Date & Time

Access

Select **Main Menu**, **Configuration**  , **Date & Time**  .

Description

In the **Date & Time** screen the system time and date can be configured.

Date & Time screen

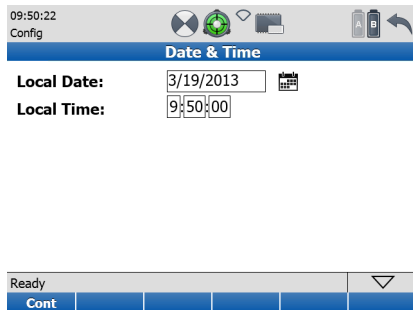

09:50:22
Config

Date & Time

Local Date: 

Local Time:

Ready

Cont

Field	Description
Local Date	Enter the local date in the format MM/DD/YY .
Local Time	Enter the local time in the format hh:mm:ss .

Available commands:

Command	Function
Cont	Confirm and return to the Configuration Menu .



After a change of the system date/time a reboot is required and the user is prompted to confirm this.

Confirmation screen

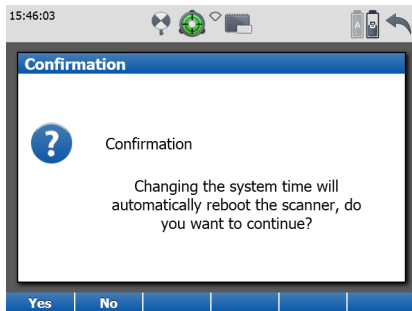

Available commands:

Command	Function
Yes	Set new date/time and reboot.
No	Do not set new date/time and return to the Configuration Menu without a reboot.

11.3 Configuration\Settings

Access

Select **Main Menu, Configuration**  , **Settings**  .

Description

In the **Settings** screen the instrument's general settings can be defined.

Settings screen

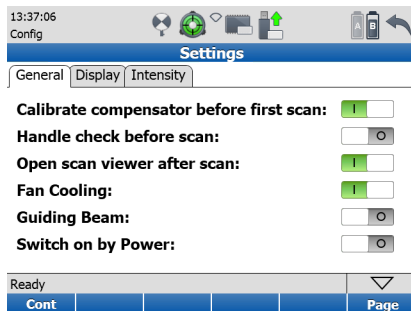

13:37:06
Config

Settings

General Display Intensity

Calibrate compensator before first scan:

Handle check before scan:

Open scan viewer after scan:

Fan Cooling:

Guiding Beam:

Switch on by Power:

Ready

Cont Page

Field	Description
Calibrate compensator before first scan	Switch on/off an automatic calibration check of the compensator. When enabled the tilt sensor is checked, before the first data acquisition and after scanner boot-up. Default is on.
Handle check before scan	Switch on/off a quick distance measurement to the zenith direction prior to a scan or image acquisition. When handle is detected a warning message informs to remove the handle.
Activate scan viewer after scan	Switch on/off the display of the Scan Viewer at the end of a scan. When disabled the Scan Parameters screen opens after a scan has been finished.
Fan Cooling	Switch on/off the cooling ventilator. Default after each scanner start is on.
Guiding Beam	Switch on/off the red laser as a guiding beam. Default after each scanner start is off.
Switch on by Power	Enable/disable automatic booting when connected to power.

Available commands:

Command	Function
Cont	Confirm and return to the Configuration Menu .
Page	Switch to the Display page.
Shift -> Reset	Delete the View.config file to reset the instrument.

Display screen

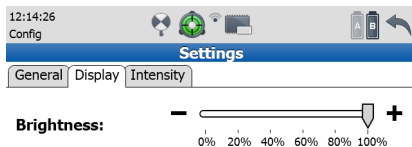

Field	Description
Brightness	Selection of display brightness. Default settings is 100%.

Available commands:

Command	Function
Cont	Confirm and return to the Configuration Menu .
Calib	Open the Screen Calibration menu.
Page	Switch to the Intensity page.

Intensity screen

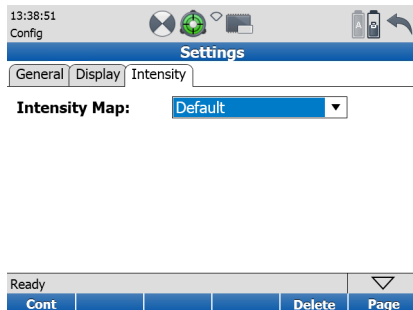

Field	Description
Intensity Map	List of installed intensity maps on the scanner. Default is the original intensity map of the ScanStation Pxx. With ScanStation C10 scanned points are intensity mapped like points taken with a ScanStation C10.



Available commands:

Command	Function
Cont	Activate the selected intensity map and return to the Main Menu .
Delete	Delete the selected intensity map. Default and ScanStation C10 are part of the firmware and cannot be deleted.
Page	Switch to the General page.



Additional intensity maps can be installed by uploading intensity map files. Refer to "12.2 Tools\Transfer" for more information.

11.4 Configuration\Language

Access Select **Main Menu, Configuration** , **Language** .

Description In the **Language** screen a list of available languages for the user interface is shown. A language can be selected or deleted from the list.



Additional languages can be installed by uploading language files. Refer to "12.2 Tools\Transfer" for more information.

Language screen

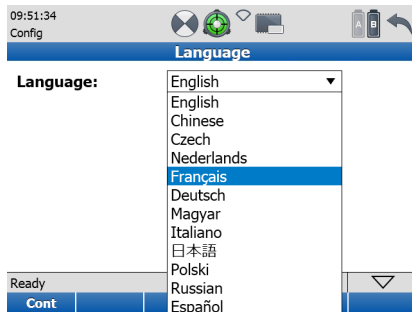



Field	Description
Language	List of installed languages on the scanner.

Available commands:

Command	Function
Cont	Activate the selected language and return to the Main Menu .
Del	Delete the selected language. English is part of the firmware and cannot be deleted.

11.5 Configuration\Wake-Up Session

Access Select **Main Menu, Configuration** , **Wake Up**  .

Description In the **Configure Wake-Up Session** screen parameters can be defined to start data acquisition automatically and to repeat it several times without any user interaction.

Configure Wake-Up Session screen

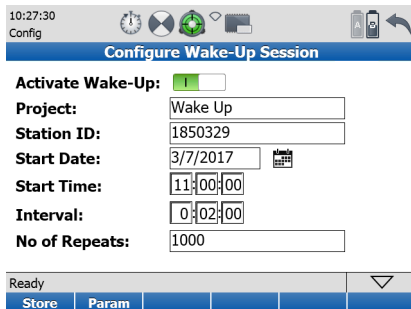

The screenshot shows the 'Configure Wake-Up Session' screen on a handheld device. At the top, the status bar displays the time '10:27:30' and the word 'Config'. Below this is a blue header bar with the title 'Configure Wake-Up Session'. The main area contains several settings:

- Activate Wake-Up:** A green toggle switch is turned on.
- Project:** A text field containing 'Wake Up'.
- Station ID:** A text field containing '1850329'.
- Start Date:** A date picker showing '3/7/2017'.
- Start Time:** A time picker showing '11:00:00'.
- Interval:** A time picker showing '0:02:00'.
- No of Repeats:** A text field containing '1000'.

At the bottom, there is a 'Ready' status bar with a dropdown arrow on the right. Below the status bar is a navigation bar with buttons for 'Store' and 'Param', followed by three empty buttons.

Field	Description
Activate Wake-Up	Switch on/off the wake-up session. An active wake-up session is indicated by the Wake Up icon  in the status bar. Default after scanner start is Off.
Project	Define a project name to store all data of a wake-up session. Default project name is Wake Up .
Station ID	Define a station name. Default station ID is the scanner serial number, for example 1850329 . For every session, a separate scan is generated in this station. Each scan is date and time coded in the format yy-mm-dd_hh-mm-ss , for example 17-03-07_11-04-00-1 .
Start Date	Define the start date when the data acquisition of the wake-up session is started for the first time with the defined parameters.
Start Time	Define the start time when the data acquisition of the wake-up session is started for the first time with the defined parameters.
Interval	Define the time interval between repeated wake-up sessions.
No of Repeats	Define how often a wake-up session should be repeated.

Command	Function
Store	Store wake-up session parameters and return to the Configuration Menu .
Param	Open the Scan Parameters screen to define Field of View , Resolution , Image Ctrl and Filters for the wake-up session.



When a wake-up session is running a message “Automatic Wake Up Session Running” is displayed in the message bar together with the remaining time of the session.



When the instrument is busy with another task while a wake-up session should be started, then the wake-up session will be skipped without any additional message.



A wake-up session can be started from the onboard user interface with data storage on the scanner’s internal storage device. Or it can be started from a remote computer with the external ScanStation Pxx simulator with data storage on the remote computer

12

Tools

Access

Select **Main Menu, Tools** .







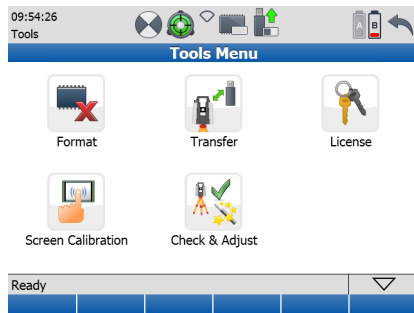

Description

In the **Tools** menu all commands for disc formatting, data transfer, license management, display and instrument calibration are available.

Tools Menu screen



Icon	Command	Description
	Confirmation	Format the complete data partition of the internal hard disc.  All project data will be erased.
	Projects	Transfer selected project or all projects to a USB memory storage device or to scanner's hard disk.
	System Files	Upload a new firmware or firmware languages to the instrument.
	Manual	Enter license key manually.
	Upload	Upload license key file from a USB memory storage device.
	Touch Calibration	Recalibrate the touch screen by clicking four points on the display.

Icon	Command	Description
Check & Adjust 	Check Angular Parameters	Determine and update angular parameters of the instrument.
	Set Range Parameters	Set the range offset of the instrument.
	Check Tilt Compensator	Check and update the tilt compensation of the instrument.
	Current Calibration	List all current instrument parameters.

Available commands:

Command	Function
Shift -> Warm Up	Start run-in procedure for elevation axis at low temperatures.

12.1

Tools\Format

Access

Select **Main Menu, Tools** , **Format**  .

Description

In the **Format** screen the data partition of the scanner's hard disc can be formatted.

Confirmation message

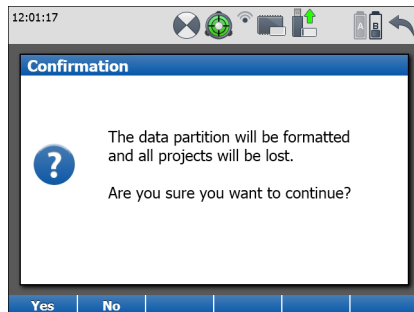

Option	Description
Yes	Starts formatting the data partition.  All project data will be erased.
No	Cancels the formatting process and returns to the Tools menu.



- Formatting is irreversible. It is recommended to backup any project files before starting **Format**.
- The **Format** command does not affect any system files. Only scan data will be erased.

12.2

Tools\Transfer

Access

Select **Main Menu, Tools** , **Transfer**  .

Description

In the **Transfer** menu projects can be transferred from the scanner's hard disc to an external USB memory storage device and vice versa. New firmware and languages can be uploaded from an external USB memory storage device to the scanner.

Project Transfer screen

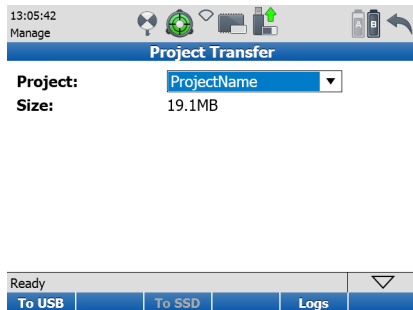

The screenshot shows the 'Project Transfer' screen. At the top, there is a status bar with the time '13:05:42' and the word 'Manage'. Below this is a navigation bar with several icons: a fan, a green circular arrow, a Wi-Fi symbol, a USB drive, and a scanner. The main title 'Project Transfer' is displayed in a blue bar. Below the title, there are two fields: 'Project:' with a dropdown menu showing 'ProjectName' and a downward arrow, and 'Size:' with the value '19.1MB'. At the bottom of the screen, there is a status bar with the word 'Ready' and a dropdown arrow. Below the status bar, there are three buttons: 'To USB', 'To SSD', and 'Logs'.

Field	Description
Project	Name of the project to be transferred. Touch the name field to open the Manage, Projects menu for selecting another project.
Size	File size (in MB) of the selected project.

Available commands:

Command	Function
To USB	Transfer the selected project to the connected USB memory storage device into the folder \Data .
To SSD	Transfer the selected project from the connected USB memory storage device to the scanner's project list. The command is available when selecting a project on the USB memory storage device.
Logs	Transfer system log files to the connected USB memory storage device into the folder \Logs .
Shift -> All to USB	Transfer all projects from the scanner's internal project list to the connected USB memory storage device into the folder \Data .

Command	Function
Shift -> All to SSD	Transfer all projects from the connected USB memory storage device to the scanner's project list.



Information message

The file system on the USB memory storage device must be NTFS, FAT32 or FAT.

In case that no USB memory storage device has been connected, the following screen will appear:

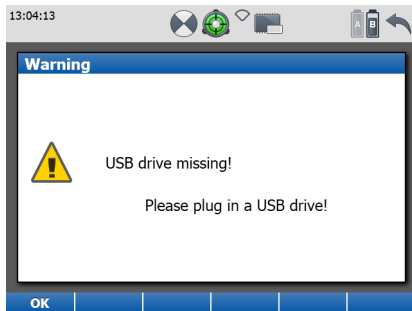

Please check whether the USB memory storage device has been connected properly and try again.

Firmware page

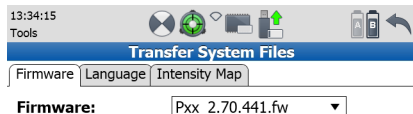

13:34:15
Tools

Transfer System Files

Firmware Language Intensity Map

Firmware: Pxx_2.70.441.fw



Ready

Cont Page

Field	Description
Firmware	Select firmware file (*.fw) from connected USB memory storage device.



- The firmware file (*.fw) must be located in the root directory of the USB memory storage device.

- Firmware files are named for example **Pxx_1.2.3.456.fw** with **1.2** being the firmware version in this case.
- Uploading a new firmware file can take up to 40 minutes. Ensure sufficient battery power or provide AC power and do not interrupt power supply during the upload process.
- Refer to the document **UpdateSSPxx_v2.0.pdf** which is enclosed with each new firmware file for detailed instructions.

Available commands:

Command	Function
Cont	Starts the upload process of the selected firmware file.
Page	Switch to the Language page.



After the upload process, the instrument restarts two times and then displays the **Main Menu**.

Language page

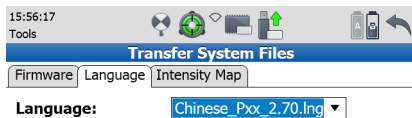

Field	Description
Language	Select language file (*.Ing) from connected USB memory storage device.



The language file (*.Ing) must be located in the main directory of the USB memory storage device.

Available commands:

Command	Function
Cont	Starts the upload process of the selected language file.
Page	Switch to the Intensity Map page.



The selected language can be activated directly after a language file transfer.

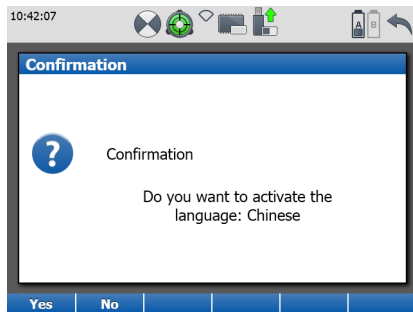

Available commands:

Command	Function
Yes	Return to the Language page of the Transfer System Files screen with the selected language activated.
No	Return to the Language page of the Transfer System Files screen without activating the selected language.



After the upload process, the language is available as an additional entry in the **Language** page of the **Firmware Language** screen. Refer to chapter "11.4 Configuration\Language" for more information.

Intensity Map screen

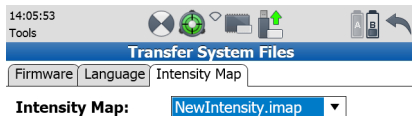

Field	Description
Intensity Map	Select intensity map file (*.imap) from connected USB memory storage device.



The intensity map file (*.imap) must be located in the main directory of the USB memory storage device.



User defined intensity map files can be created in the external Pxx Intensity Map Editor.

Available commands:

Command	Function
Cont	Starts the upload process of the selected intensity map file.
Page	Switch to the Firmware page.

12.3

Tools\License

Access

Select **Main Menu, Tools** , **License**  .

Description

In the **License** screen the firmware maintenance license key can be entered manually or uploaded via key file. A valid license key is required to be able to update the ScanStation P40/P30 firmware.

Manual page

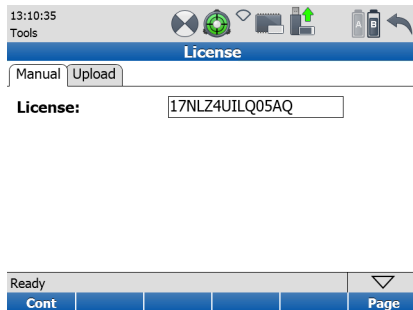

The screenshot shows the 'License' screen in the ScanStation P40/P30 interface. At the top, the time is 13:10:35 and the page is titled 'Tools'. Below the title bar, there are several icons: a signal strength indicator, a refresh icon, a Wi-Fi icon, a USB icon, a green arrow pointing up, and a mobile device icon with a refresh arrow. The main content area has a blue header with the word 'License'. Below the header, there are two buttons: 'Manual' and 'Upload'. The 'License:' label is followed by a text input field containing the license key '17NLZ4UILQ05AQ'. At the bottom of the screen, there is a status bar with the word 'Ready' and a dropdown arrow. Below the status bar, there are five blue buttons: 'Cont', followed by three unlabeled buttons, and 'Page'.

Field	Description
License	Enter the 14-digit license key manually.  The license key is not case sensitive.

Available commands:

Command	Function
Cont	Confirm the entered license key.
Page	Switch to the Upload page.

Upload page

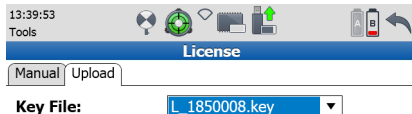

13:39:53
Tools

License

Manual Upload

Key File: L_1850008.key



Ready

Cont Page

Field	Description
Key File	Select the license key file (*.key) from the connected USB memory storage device to load onto the scanner.



- The license key file (*.key) must be located in the root directory of the USB memory storage device.
- License key files are named for example "L_185xxxx.key" with 185xxxx being the scanner's serial number.

Available commands:

Command	Function
Cont	Confirm and load the license key from the selected license key file.
Page	Switch to the Manual page.

12.4

Tools\Screen Calibration

Access

Select **Main Menu, Tools** , **Screen Calibration**  .

Description

In the **Screen Calibration** menu the onboard touch screen can be calibrated.

Confirmation message

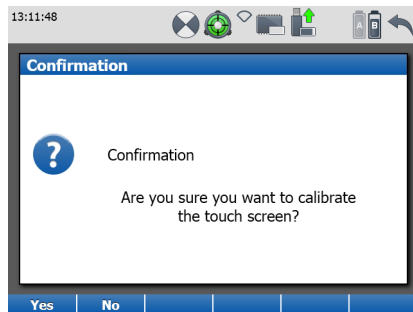

Option	Description
Yes	Start the touch screen calibration process. Then click the centres of four calibration points which appear consecutively on the display.
No	Cancel the touch screen calibration process and return to the Tools menu.

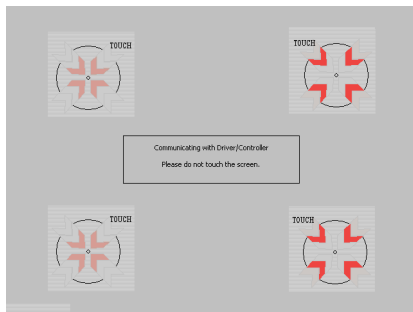

12.5

Check & Adjust

Access





Select **Main Menu, Check & Adjust** .

Description

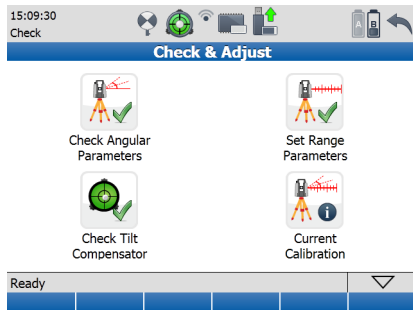
In the **Check & Adjust** menu all commands for checking angular parameters, setting range parameters, checking the tilt compensator, and to check the current calibration settings are available.

Check & Adjust screen



Icon	Description
Check Angular Parameters 	Angular system parameters can be determined by means of a field procedure and registered in the instrument.
Set Range Parameters 	The range offset parameter, which must be determined on a reference baseline, can be registered in the instrument.
Check Tilt Compensator 	The tilt sensor can be checked and its parameters be updated.
Current Calibration 	Current instrument parameters can be displayed and reset to factory default values.

Check Angular Parameters screen

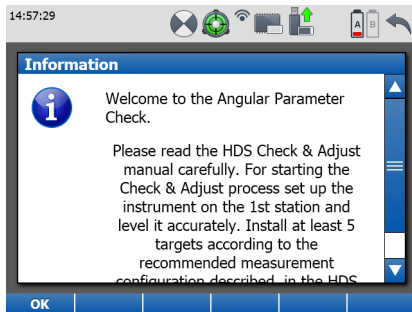

Refer to the separate Leica HDS Check & Adjust User Manual for step-by-step instructions and details about the setup of a test configuration.

Set Range Offset screen



Update the system range offset of your instrument after reliable results on a reference baseline according to:
 correct dist. = offset + measured dist.
 Consider the sign of your setting!

Range Offset: m



Field	Description
Range Offset	Range offset determined on a distance reference baseline.

Available commands:

Command	Function
Set	Registers the current range offset which will be added to all future distance measurements.

Check Tilt Compensator screen

Parameter ▲	Result ▲
comp. L	11"
comp. T	-2"

Ready	▼
Set	

Field	Description
Parameter	List of instrument tilt parameters. <ul style="list-style-type: none">• comp. L = compensator longitudinal index error.• comp. T = compensator transversal index error.
Result	Current value of the instrument tilt parameter.

Available commands:

Command	Function
Set	Registers the calculated tilt parameters.  All further scans are corrected by these values.

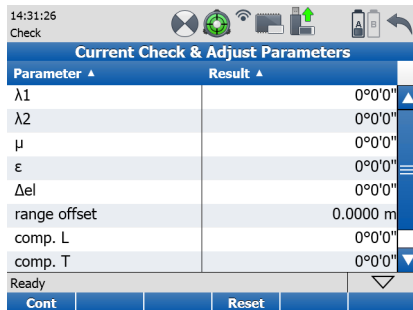
Current Check &
Adjust Parameters
screen

Parameter ▲	Result ▲
$\lambda 1$	0°0'0" ▲
$\lambda 2$	0°0'0"
μ	0°0'0"
ϵ	0°0'0" ≡
$\Delta e l$	0°0'0"
range offset	0.0000 m
comp. L	0°0'0"
comp. T	0°0'0" ▼
Ready	▽
Cont	Reset

Field	Description
Parameter	<p>List of instrument parameters.</p> <ul style="list-style-type: none"> • $\lambda 1, \lambda 2$ = laser alignment deviations. • μ = deviation of the line of sight. • ε = deviation of the tilting axis. • $\Delta e l$ = deviation of the vertical index. • range offset = range offset determined on a distance reference baseline. • comp. L = compensator longitudinal index error. • comp. T = compensator transversal index error.
Result	Current value of the instrument parameter.

Available commands:

Command	Function
Cont	Return to the Main Menu.
Reset	Reset all user-determined parameters to the default in-factory calibration.

Leica Geosystems AG

Heinrich-Wild-Strasse
CH-9435 Heerbrugg
Switzerland

Phone +41 71 727 31 31

www.leica-geosystems.com

- when it has to be **right**

Leica
Geosystems

829113-5.0.0en

Original text

Printed in Switzerland © 2016 Leica Geosystems AG, Heerbrugg, Switzerland