

UNDERSTANDING GROUND RESISTANCE TESTING

Soil Resistivity • Ground Resistance • 3-Point

4-point Measurements • Clamp-On Measurements



Technical Hotline:
(800) 343-1391 • (508) 698-2115

www.aemc.com





UNDERSTANDING **GROUND RESISTANCE TESTING** **A One Day Training Seminar**

In today's rapidly changing world of technological advances, good grounding is more important than ever to prevent costly damage and downtime due to service interruptions and inoperative surge protection caused by poor grounds. Grounding systems offer protection from natural phenomenon such as lightning by channeling the lightning current to the ground, protecting personnel from injury and protecting system components from damage. In electric power systems with ground returns, grounds help ensure rapid operation of the protection relays by providing low resistance fault paths in the event of unexpected potentials due to faults.

Low ground resistance is required to meet NEC®, OSHA and other electrical safety standards.

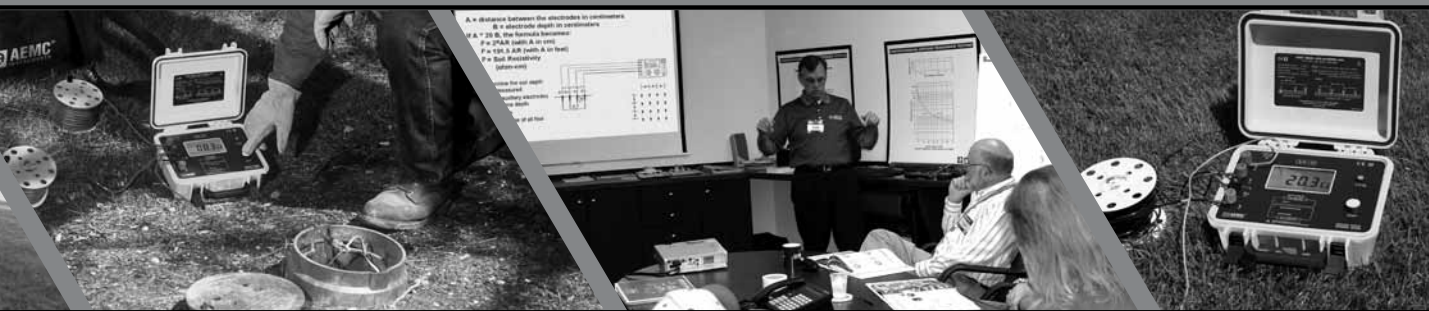

Contents

Soil Resistivity	1
Soil Resistivity Measurements	3
4 Point Measurement	
Ground Electrodes	5
Ground Resistance Testing Principle	8
Fall-of-Potential – 3-Point Measurement	
Multiple Electrode Systems	12
Tech Tips	13
Clamp-On Ground Resistance Measurement	16
<i>(Models 3711 & 3731*)</i>	
Telecommunications	20
References	23
Ground Nomograph	24
Fall-of-Potential Plot	25

➔ *Models 3711 & 3731 have replaced Models 3710 & 3730*

Soil Resistivity

Why Measure Soil Resistivity?

Soil resistivity measurements have a threefold purpose. First, data is used to make sub-surface geophysical surveys as an aid in identifying ore locations, depth to bedrock and other geological phenomena. Second, resistivity has a direct impact on the degree of corrosion in underground pipelines. A decrease in resistivity relates to an increase in corrosion activity and therefore dictates the protective treatment to be used. Third, soil resistivity directly affects the design of a grounding system, and it is to that task that this discussion is directed. When designing an extensive grounding system, it is advisable to locate the area of lowest soil resistivity in order to achieve the most economical grounding installation.

➔ **Note:** The lower the soil resistivity value, the lower the grounding electrode resistance will be.

Effects of Soil Resistivity on Grounding Electrode Resistance

Soil resistivity is the key factor that determines what the resistance of a grounding electrode system will be, and to what depth it must be driven to obtain low ground resistance. The resistivity of the soil varies widely throughout the world and changes seasonally. Soil resistivity is determined largely by its content of electrolytes, which consist of moisture, minerals and dissolved salts. A dry soil has high resistivity if it contains no soluble salts.

Soil	Resistivity (approx.), Ω -cm		
	Min	Average	Max
Ashes, cinders, brine, waste	590	2370	7000
Clay, shale, gumbo, loam	340	4060	16,300
Same, with varying proportions of sand and gravel	1020	15,800	135,000
Gravel, sand, stones with little clay or loam	59,000	94,000	458,000

Figure 1

Factors Affecting Soil Resistivity

Two samples of soil, when thoroughly dried, may in fact become very good insulators having a resistivity in excess of $10^9 \Omega$ -cm. The resistivity of the soil sample is seen to change quite rapidly until approximately 20% or greater moisture content is reached. (Figure 2)

Moisture content % by weight	Resistivity Ω -cm	
	Top soil	Sandy loam
0	$>10^9$	$>10^9$
2.5	250,000	150,000
5	165,000	43,000
10	53,000	18,500
15	19,000	10,500
20	12,000	6300
30	6400	4200

Figure 2

The resistivity of the soil is also influenced by temperature. Figure 3 shows the variation of the resistivity of sandy loam, containing 15.2% moisture, with temperature changes from 20° to -15°C. In this temperature range the resistivity is seen to vary from 7200 to 330,000Ω-cm.

Temperature		Resistivity Ω-cm
°C	°F	
20	68	7200
10	50	9900
0	32 (water)	13,800
0	32 (ice)	30,000
-5	23	79,000
-15	14	330,000

Figure 3

Because soil resistivity directly relates to moisture content and temperature, it is reasonable to assume that the resistance of any grounding system will vary throughout the different seasons of the year. Such variations are shown in Figure 4. Since both temperature and moisture content become more stable at greater distances below the surface of the earth, it follows that a grounding system, to be most effective at all times, should be constructed with the ground rod driven down a considerable distance below the surface of the earth. Best results are obtained if the ground rod reaches the water table.

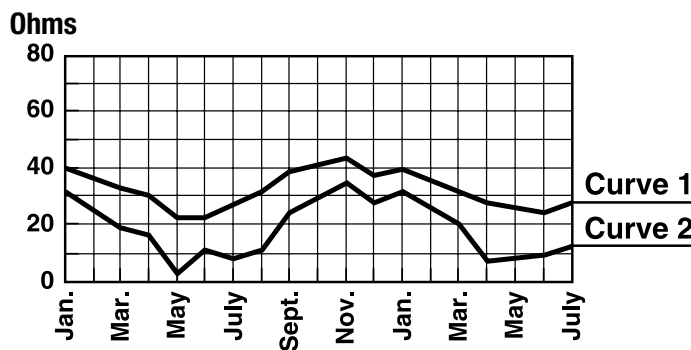

Figure 4

Seasonal variation of earth resistance with an electrode of $\frac{3}{4}$ " pipe in rather stony clay soil. Depth of electrode in earth is 3 ft for Curve 1, and 10 ft for Curve 2

In some locations, the resistivity of the earth is so high that low-resistance grounding can be obtained only at considerable expense and with an elaborate grounding system. In such situations, it may be economical to use a ground rod system of limited size and to reduce the ground resistivity by periodically increasing the soluble chemical content of the soil. Figure 5 shows the substantial reduction in resistivity of sandy loam brought about by an increase in chemical salt content.

Chemically treated soil is also subject to considerable variation of resistivity with temperature changes, as shown in Figure 6. If salt treatment is employed, it is necessary to use ground rods which will resist chemical corrosion.

THE EFFECT OF SALT* CONTENT ON THE RESISTIVITY OF SOIL
(Sandy loam, Moisture content, 15% by weight, Temperature 17°C)

Added Salt (% by weight of moisture)	Resistivity (Ω -cm)
0	10,700
0.1	1800
1.0	460
5	190
10	130
20	100

Figure 5

THE EFFECT OF TEMPERATURE ON THE RESISTIVITY OF SOIL CONTAINING SALT*

(Sandy loam, 20% moisture. Salt 5% of weight of moisture)

Temperature (Degrees C)	Resistivity (Ω -cm)
20	110
10	142
0	190
-5	312
-13	1440

Figure 6

*Such as copper sulfate, sodium carbonate, and others.
Salts must be EPA or local ordinance approved prior to use.

Soil Resistivity Measurements

4-Point Measurement

Resistivity measurements are of two types; the 2-Point and the 4-Point method. The **2-Point method** is simply the resistance measured between two points. For most applications the most accurate is the **4-Point method** which is used in Ground Tester Model 4620, 4630, 6470-B, 6471 or 6472. The 4-Point method (Figures 7 and 8), as the name implies, requires the insertion of four equally spaced and in-line electrodes into the test area. A known current from a constant current generator is passed between the outer electrodes. The potential drop (a function of the resistance) is then measured across the two inner electrodes. The Model 4620, 4630, 6470-B, 6471 and 6472 are calibrated to read directly in ohms. Where space or access to inserting rods is a problem, the Miller box and multiple depth testing may be used. The Schlumberger method is used mainly for geologic surveys.

Where: A = distance between the electrodes in centimeters

B = electrode depth in centimeters

If $A > 20 B$, the formula becomes:

$$\rho (\Omega\text{-cm}) \rho = 2\pi AR \text{ (with A in cm)}$$

$$\rho (\Omega\text{-cm}) \rho = 191.5 AR \text{ (with A in ft)}$$

$$\rho (\Omega\text{-m}) \rho = 2\pi AR \text{ (with A in m)}$$

NOTE:

To use feet instead of cm:
 $2\pi \times (\text{conversion from cm to ft}) =$
 $(2) (3.14) [(12) (2.54) = 191.5]$

The value to be used for ρ is the average resistivity of the ground at a depth equivalent to the distance "A" between two electrodes for all tests taken.

Given a sizable tract of land in which to determine the optimum soil resistivity, some intuition is in order. Assuming that the objective is low resistivity, preference should be given to an area containing moist loam as opposed to a dry sandy area. Consideration must also be given to the depth at which resistivity is required.

$$\rho (\Omega\text{-cm}) = 2\pi AR \times 100 \text{ (with A in m)}$$

Example

After inspection, the area investigated has been narrowed down to a plot of ground approximately 75 square feet (7m²). Assume that you need to determine the resistivity at a depth of 15 ft (450cm). The distance "A" between the electrodes must then be equivalent to the depth at which average resistivity is to be determined (15 ft, or 450cm). Using the more simplified Wenner formula ($\rho = 2\pi AR$), the electrode depth must then be no more than 1/20th of the electrode spacing or 8^{7/8}" (22.5cm).

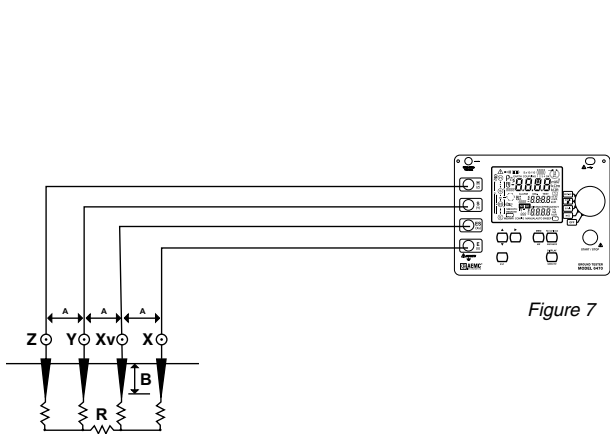

Figure 7

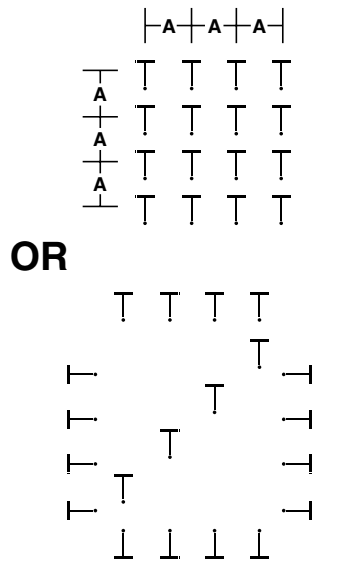

Figure 8

Lay out the electrodes in a grid pattern and connect to the instrument as shown in Figure 8. Proceed as follows:

- Remove the shorting link between X and Xv (C1, P1)
- Connect all four auxiliary rods (Figure 7)

For example, if the reading is $R = 15$

$$\rho (\text{resistivity}) = 2\pi \times A \times R$$

$$A (\text{distance between electrodes}) = 450\text{cm}$$

$$\rho = 6.28 \times 15 \times 450 = 42,390\Omega\text{-cm}$$

Grounding Electrodes

The term “**ground**” is defined as a conducting connection by which a circuit or equipment is connected to the earth. The connection is used to establish and maintain as closely as possible the potential of the earth on the circuit or equipment connected to it. A “ground” consists of a grounding conductor, a bonding connector, its grounding electrode(s), and the soil in contact with the electrode.

“Grounds” have several protection applications. For natural phenomena such as lightning, grounds are used to discharge the system of current before personnel can be injured or system components damaged. For foreign potentials due to faults in electric power systems with ground returns, grounds help ensure rapid operation of the protection relays by providing low resistance fault current paths. This provides for the removal of the foreign potential as quickly as possible. The ground should drain the foreign potential before personnel are injured and the power or communications system is damaged.

Ideally, to maintain a reference potential for instrument safety, protect against static electricity, and limit the system to frame voltage for operator safety, a ground resistance should be zero ohms. In reality, as we describe further in the text, this value cannot be obtained.

Last but not least, low ground resistance is essential to meet NEC®, OSHA and other electrical safety standards.

Figure 9 illustrates a grounding rod. The resistance of the electrode has the following components:

- (A) The resistance of the metal and that of the connection to it.
- (B) The contact resistance of the surrounding earth to the electrode.
- (C) The resistance in the surrounding earth to current flow or earth resistivity which is often the most significant factor.

➔ **More specifically**

- (A) Grounding electrodes are usually made of a very conductive metal (copper or copper clad) with adequate cross sections so that the overall resistance is negligible.
- (B) The National Institute of Standards and Technology has demonstrated that the resistance between the electrode and the surrounding earth is negligible if the electrode is free of paint, grease, or other coating, and if the earth is firmly packed.

- (C) The only component remaining is the resistance of the surrounding earth. The electrode can be thought of as being surrounded by concentric shells of earth or soil, all of the same thickness. The closer the shell to the electrode, the smaller its surface; hence, the greater its resistance. The farther away the shells are from the electrode, the greater the surface of the shell; hence, the lower the resistance. Eventually, adding shells at a distance from the grounding electrode will no longer noticeably affect the overall earth resistance surrounding the electrode. The distance at which this effect occurs is referred to as the effective resistance area and is directly dependent on the depth of the grounding electrode.

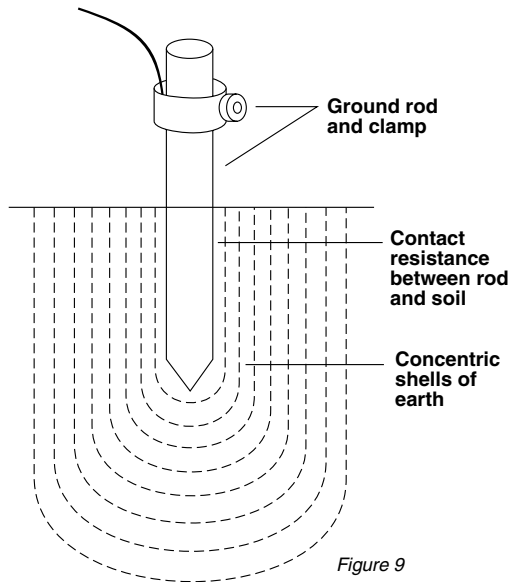

Figure 9

Effect of Grounding Electrode Size and Depth on Resistance

Size: Increasing the diameter of the rod does not significantly reduce its resistance. Doubling the diameter reduces resistance by less than 10%. (Figure 10)

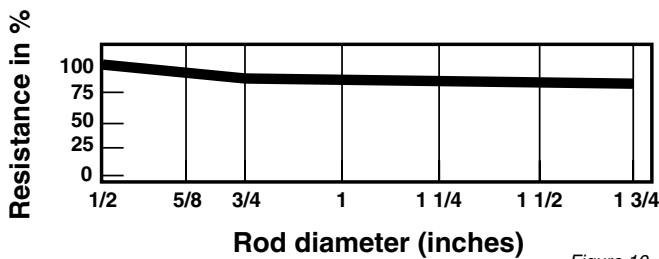

Figure 10

Depth: As a ground rod is driven deeper into the earth, its resistance is substantially reduced. In general, doubling the rod length reduces the resistance by an additional 40% (Figure 11). The NEC (2008, 250.52 (A)(5)) requires a minimum of 8 ft. (2.4m) in contact with the soil. NEC (2008, 250.52 (A)(5)(b)) states that rod electrodes of stainless steel and copper or zinc coated steel shall be at least 15.87mm (5/8 in) diameter, unless listed and not less than 12.70mm (1/2 in) in diameter.

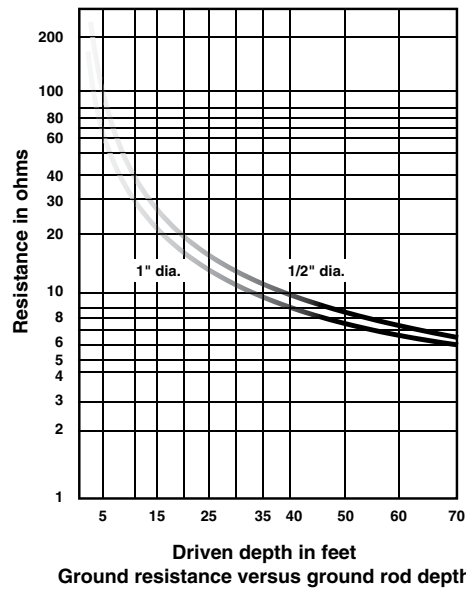

Figure 11

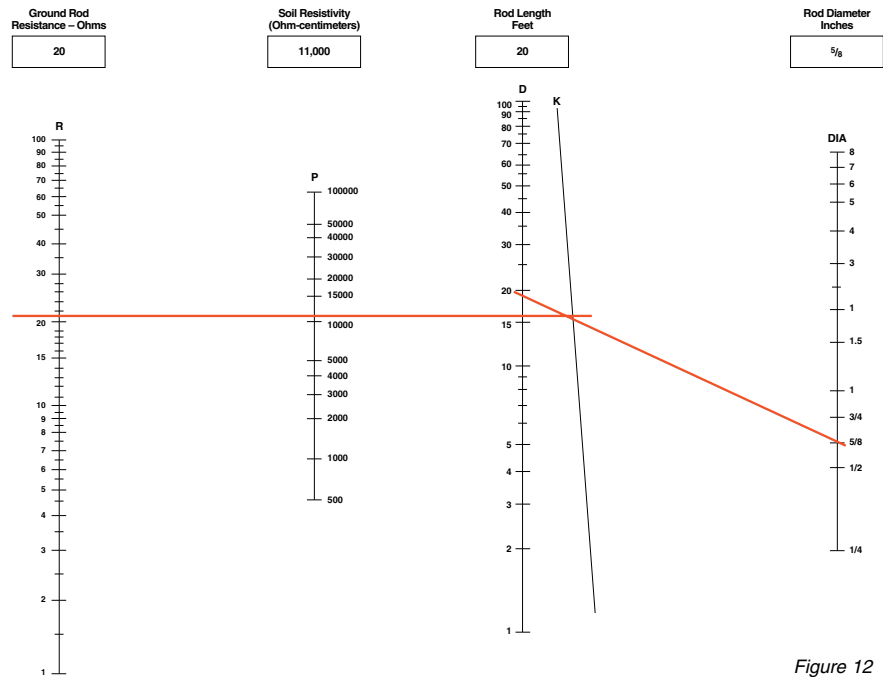

Figure 12

Represents example of a 20Ω, 20 ft ground rod

Grounding Nomograph

1. Select required resistance on R scale
2. Select apparent resistivity on P scale
3. Lay straightedge on R and P scale, and allow to intersect with K scale
4. Mark K scale point
5. Lay straightedge on K scale point & DIA scale, and allow to intersect with D scale
6. Point on D scale will be rod depth required for resistance on R scale

Ground Resistance Testing Principle

Fall-of-Potential – 3-Point Measurement

The potential difference between rods X and Y is measured by a voltmeter, and the current flow between rods X and Z is measured by an ammeter. (Note: X, Y and Z may be referred to as X, P and C or H, S or E in a 3-Point tester or C1, P2 and C2 in a 4-Point tester.) (Figure 13)

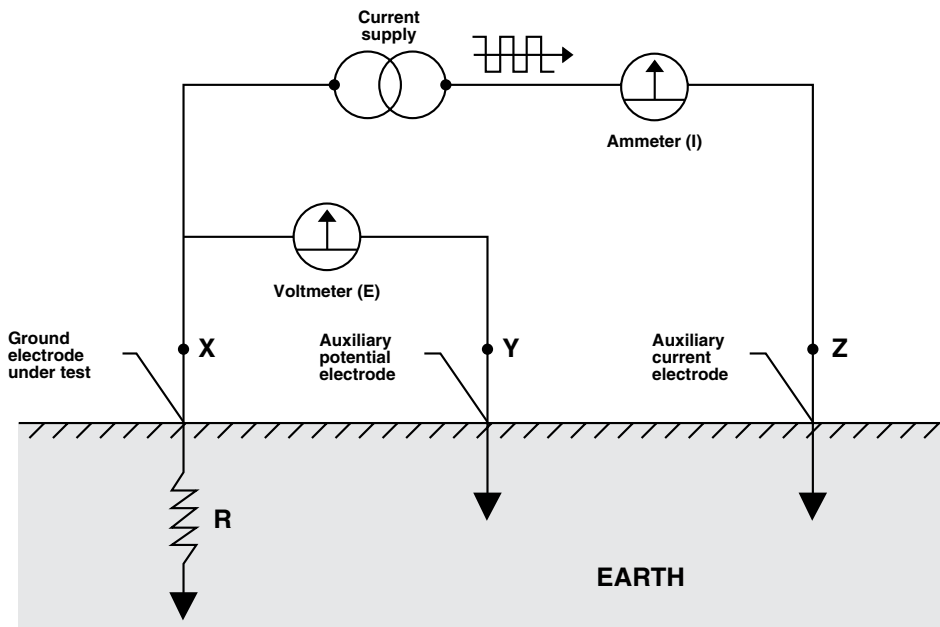

Figure 13

By Ohm's Law $E = RI$ or $R = E/I$, we may obtain the grounding electrode resistance R. If $E = 20V$ and $I = 1A$, then

$$R = \frac{E}{I} = \frac{20}{1} = 20\Omega$$

This method requires the service neutral and any other grounding system be disconnected. It is not necessary to carry out all the measurements when using a ground tester. The ground tester will measure directly by generating its own current and displaying the resistance of the grounding electrode.

Position of the Auxiliary Electrodes on Measurements

The goal in precisely measuring the resistance to ground is to place the auxiliary current electrode Z far enough from the grounding electrode under test so that the auxiliary potential electrode Y will be outside of the effective resistance areas of both the grounding electrode and the auxiliary current electrode. The best way to find out if the auxiliary potential rod Y is outside the effective resistance areas is to move it between X and Z and to take a reading at each location (See Figure 15) If the auxiliary potential rod Y is in an effective resistance area (or in both if they overlap, as in Figure 14), by displacing it, the readings taken will vary noticeably in value. Under these conditions, no exact value for the resistance to ground may be determined.

On the other hand, if the auxiliary potential rod Y is located outside of the effective resistance areas (Figure 15), as Y is moved back and forth the reading variation is minimal. The readings taken should be relatively close to each other, and are the best values for the resistance to ground of the ground X. The readings should be plotted to ensure that they lie in a “plateau” region as shown in Figure 15. The region is often referred to as the “62% area.” (See 62% method below for explanation) Readings every 5-10% of the distance from x to z are suggested. The average of the closest three readings (user defined) would be considered the resistance between earth and the test point.

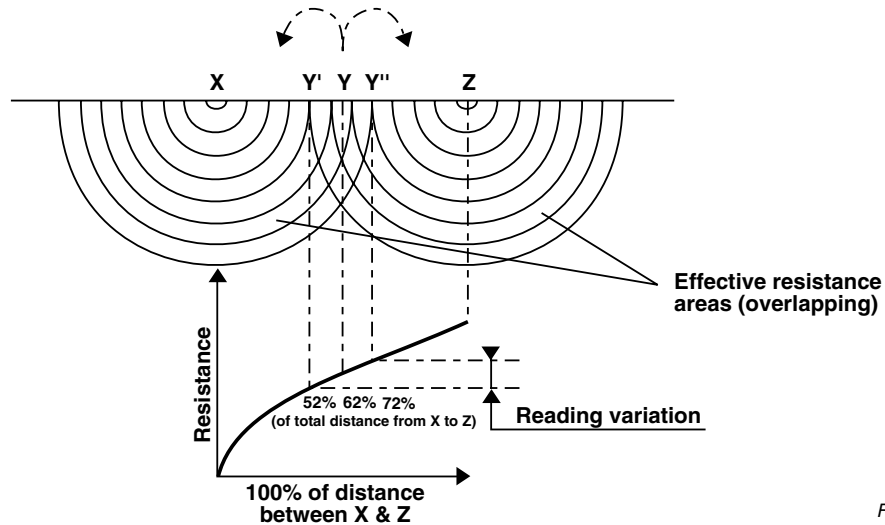

Figure 14

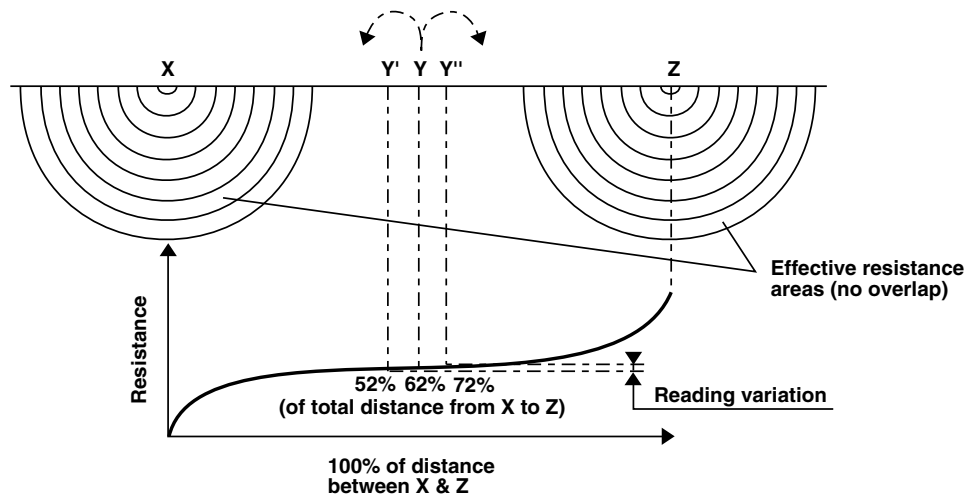

Figure 15

Measuring Resistance of Grounding Electrodes 62% Method

The 62% method has been adopted after graphical consideration and after actual test. It is the most accurate method but is limited by the fact that *the ground tested is a single unit*.

This method applies only when all three electrodes are in a straight line and the ground is a *single* electrode, pipe, or plate, etc., as in Figure 16.

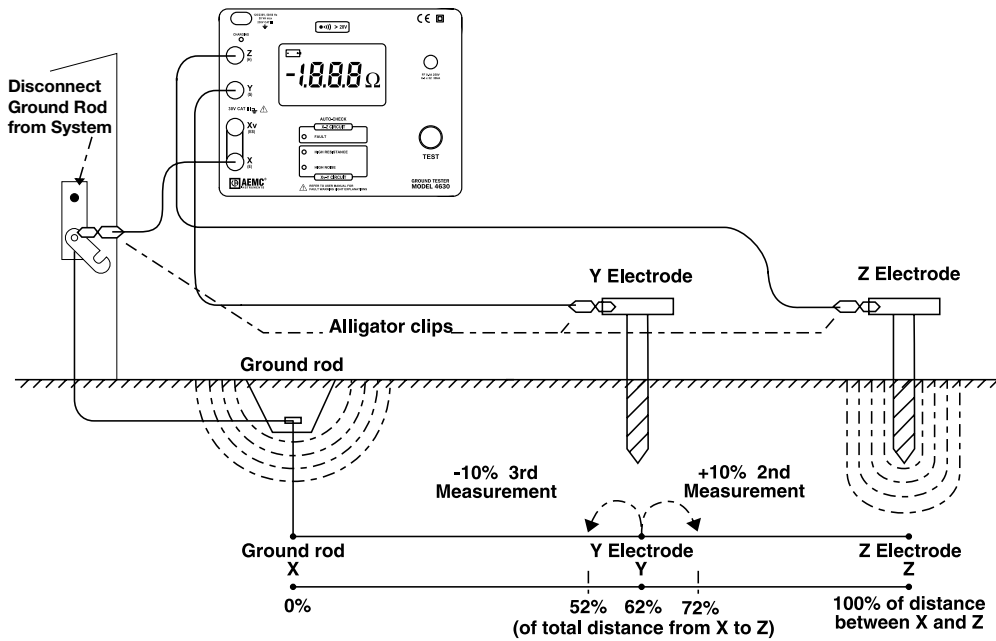

Figure 16

Consider Figure 17, which shows the effective resistance areas (concentric shells) of the grounding electrode X and of the auxiliary current electrode Z. The resistance areas overlap. If readings were taken by moving the auxiliary potential electrode Y towards either X or Z, the reading differentials would be great and one could not obtain a reading within a reasonable band of tolerance. The sensitive areas overlap and act constantly to increase resistance as Y is moved away from X.

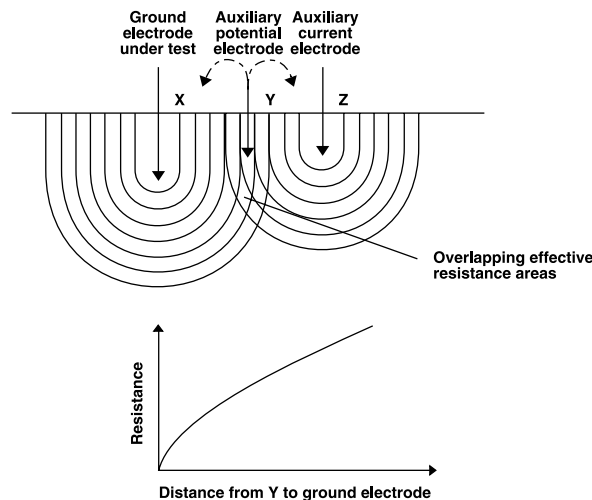

Figure 17

Now consider Figure 18, where the X and Z electrodes are sufficiently spaced so that the areas of effective resistance do not overlap. If we plot the resistance measured we find that the measurements level off when Y is placed at 62% of the distance from X to Z, and that the readings on either side of the initial Y setting are most likely to be within the established tolerance band. This tolerance band is defined by the user and expressed as a percent of the initial reading: $\pm 2\%$, $\pm 5\%$, $\pm 10\%$, etc.

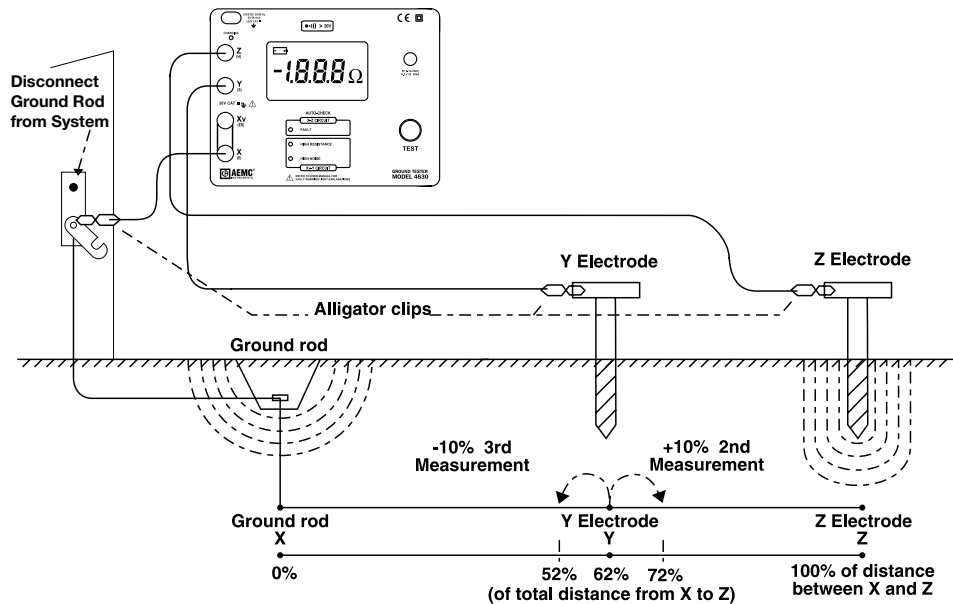

Figure 18

Auxiliary Electrode Spacing

No definite distance between X and Z can be given, since this distance is relative to the diameter of the electrode tested, its length, the homogeneity of the soil tested, and particularly, the effective resistance areas. However, an approximate distance may be determined from the following chart which is given for a homogeneous soil and an electrode of 1" in diameter. (For a diameter of 1/2", reduce the distance by 10%; for a diameter of 2" increase the distance by 10%; for a diameter of 3/8", reduce the distance by 8%.)

APPROXIMATE DISTANCE TO AUXILIARY ELECTRODES USING THE 62% METHOD

Depth Driven	Distance to Y	Distance to Z
6 ft	45 ft	72 ft
8 ft	50 ft	80 ft
10 ft	55 ft	88 ft
12 ft	60 ft	96 ft
18 ft	71 ft	115 ft
20 ft	74 ft	120 ft
30 ft	86 ft	140 ft

Figure 19

Multiple Rod Spacing

Parallel multiple electrodes yield lower resistance to ground than a single electrode. High-capacity installations require low grounding resistance. Multiple rods are used to provide this resistance.

A second rod does not provide a total resistance of half that of a single rod unless the two are several rod lengths apart. To achieve the grounding resistance, place multiple rods one rod length apart in a line, circle, hollow triangle, or square. The equivalent resistance can be calculated by dividing by the number of rods and multiplying by the factor X (see next page). Additional considerations regarding step and touch potentials should be addressed by the geometry.

MULTIPLE FACTORS FOR MULTIPLE RODS

Number of Rods	X
2	1.16
3	1.29
4	1.36
8	1.68
12	1.80
16	1.92
20	2.00
24	2.16

Figure 20

Placing additional rods within the periphery of a shape will not reduce the grounding resistance below that of the peripheral rods alone.

Multiple Electrode Systems

A single driven grounding electrode is an economical and simple means of making a good ground system. But sometimes a single rod will not provide sufficient low resistance, and several grounding electrodes will be driven and connected in parallel by a cable. Very often when two, three or four grounding electrodes are being used, they are driven in a straight line; when four or more are being used, a hollow square configuration is used and the grounding electrodes are still connected in parallel and are equally spaced. (Figure 21)

In multiple electrode systems, the 62% method electrode spacing may no longer be applied directly. The distance of the auxiliary electrodes is now based on the maximum grid distance (i.e. In a square, the diagonal; in a line, the total length). For example, a square having a side of 20 ft will have a diagonal of approximately 28 ft). Three readings, minimum, are still required for proper testing.

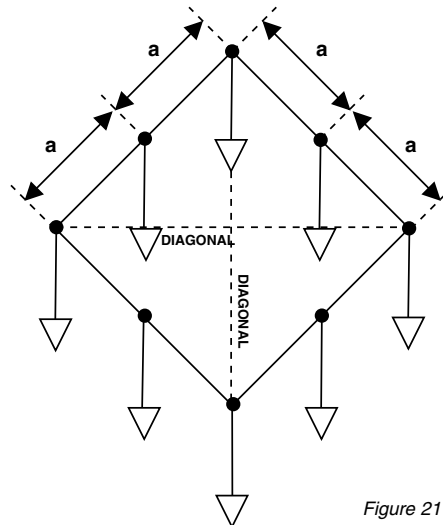

Figure 21

MULTIPLE ELECTRODE SYSTEM

Max Grid Distance	Distance to Y	Distance to Z
6 ft	78 ft	125 ft
8 ft	87 ft	140 ft
10 ft	100 ft	160 ft
12 ft	105 ft	170 ft
14 ft	118 ft	190 ft
16 ft	124 ft	200 ft
18 ft	130 ft	210 ft
20 ft	136 ft	220 ft
30 ft	161 ft	260 ft
40 ft	186 ft	300 ft
50 ft	211 ft	340 ft
60 ft	230 ft	370 ft
80 ft	273 ft	440 ft
100 ft	310 ft	500 ft
120 ft	341 ft	550 ft
140 ft	372 ft	600 ft
160 ft	390 ft	630 ft
180 ft	434 ft	700 ft
200 ft	453 ft	730 ft

Figure 22

Tech Tips
Excessive Noise

Excessive noise may interfere with testing because of the long leads used to perform a Fall-of-Potential test. A voltmeter can be utilized to identify this problem. Connect the “X”, “Y” and “Z” cables to the auxiliary electrodes as for a standard ground resistance test. Use the voltmeter to test the voltage across terminals “X” and “Z”. (See Figure 25)

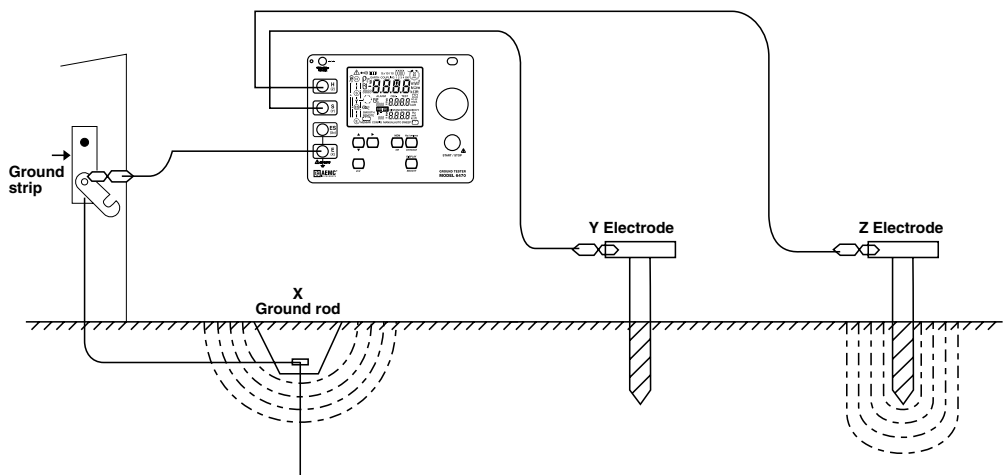

Figure 25

The voltage reading should be within stray voltage tolerances acceptable to your ground tester. If the voltage exceeds this value, try the following techniques:

A) Braid the auxiliary cables together. This often has the effect of canceling out the common mode voltages between these two conductors. (Figure 26)

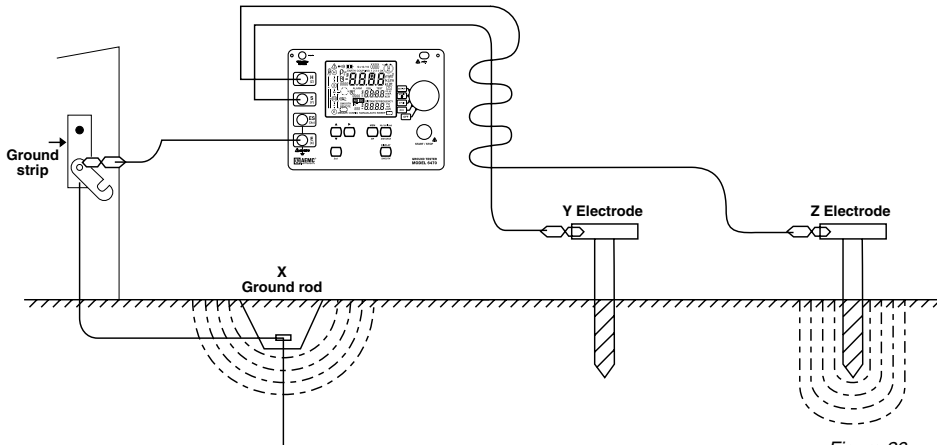

Figure 26

B) If the previous method fails, try changing the alignment of the auxiliary cables so that they are not parallel to power lines above or below the ground. (Figure 27)

C) If a satisfactory low voltage value is still not obtained, the use of shielded cables may be required. The shield acts to protect the inner conductor by capturing the voltage and draining it to ground. (Figure 28)

1. Float the shields at the auxiliary electrodes
2. Connect all three shields together at (but not to) the instrument
3. Solidly ground the remaining shield to the ground under test

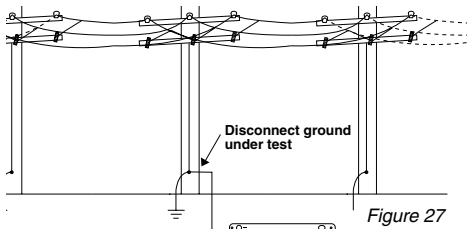

Figure 27

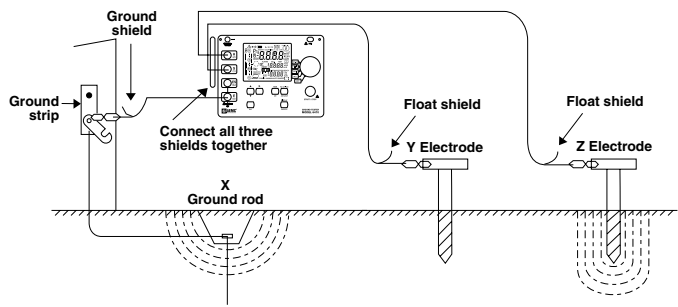

Figure 28

Excessive Auxiliary Rod Resistance

The inherent function of a Fall-of-Potential ground tester is to input a constant current into the earth and measure the voltage drop by means of auxiliary electrodes. Excessive resistance of one or both auxiliary electrodes can inhibit this function. This is caused by high soil resistivity or poor contact between the auxiliary electrode and the surrounding dirt. (Figure 29)

To ensure good contact with the earth, stamp down the soil directly around the auxiliary electrode to remove air gaps formed when inserting the rod. If soil resistivity is the problem, pour water around the auxiliary electrodes. This reduces the auxiliary electrode's contact resistance without affecting the measurement.

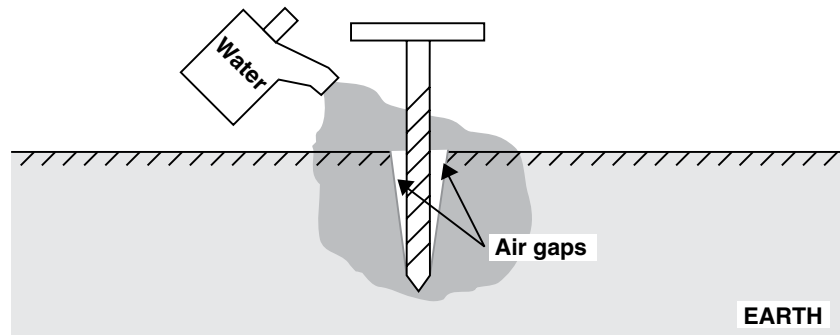

Figure 29

Asphalt, soil, concrete, rock, etc...

Sometimes a test must be performed on a ground rod that is surrounded by a tar or concrete mat, where auxiliary electrodes cannot be driven easily. In such cases, metal screens and water can be used to replace auxiliary electrodes, as shown in Figure 30.

Place the screens on the asphalt, soil, concrete, rock, the same distance from the ground rod under test as you would auxiliary electrodes in a standard fall-of-potential test. Pour water on the screens and allow it to soak in. These screens will now perform the same function as would driven auxiliary electrodes.

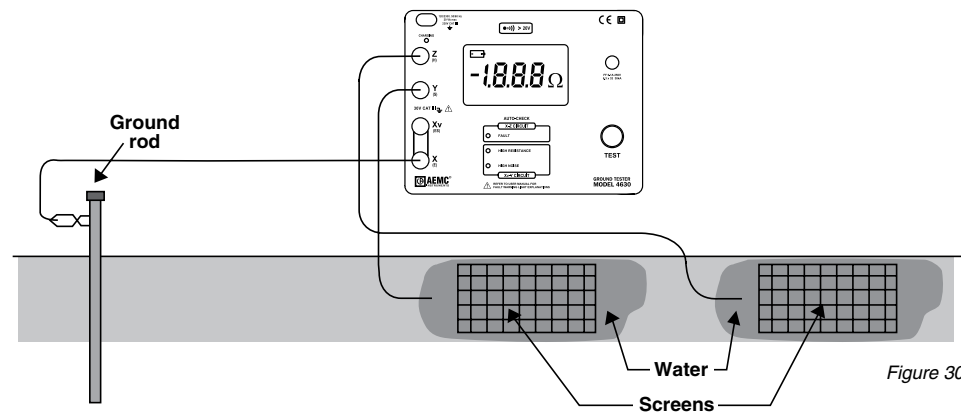

Figure 30

Clamp-On Ground Resistance Measurement

Models 3711 & 3731

This measurement method is innovative and quite unique. It offers the ability to measure the resistance without disconnecting the ground. This type of measurement also offers the advantage of including the bonding to ground and the overall grounding connection resistances. This method requires connection of utility neutral or another grounding system so that the signal goes out to the other system and returns to the test point through the earth.

Principle of Operation

Usually, a common distribution line grounded system can be simulated as a simple basic circuit as shown in Figure 32 or an equivalent circuit, shown in Figure 33. If voltage E is applied to any measured grounding point Rx through a special transformer, current I flows through the circuit, thereby establishing the following equation.

$$\frac{V}{I} = R_x + \frac{1}{\sum_{i=1}^n \frac{1}{R_i}} \quad \text{where, usually} \quad R_x \gg \frac{1}{\sum_{i=1}^n \frac{1}{R_i}}$$

Therefore, $E/I = R_x$ is established. If I is detected with E kept constant, measured grounding point resistance can be obtained. Refer again to Figures 31 and 32. Current is fed to a special transformer via a power amplifier from a 2.4kHz constant voltage oscillator. This current is detected by a detection CT. Only the 2.4kHz signal frequency is amplified by a filter amplifier. This occurs before the A/D conversion and after synchronous rectification. It is then displayed on the LCD. The filter amplifier is used to cut off both earth current at commercial frequency and high-frequency noise. Voltage is detected by coils wound around the injection CT which is then amplified, rectified, and compared by a level comparator. If the clamp is not closed properly, an “open jaw” annunciator appears on the LCD.

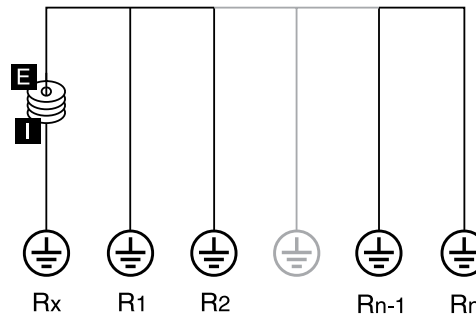

Figure 31

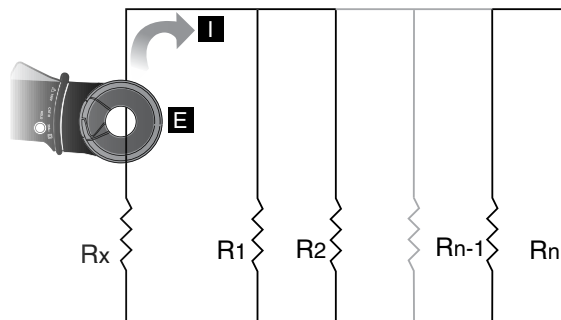

Figure 32

Examples: Typical In-Field Measurements

Pole Mounted Transformer

Remove any molding covering the ground conductor, and provide sufficient room for the Model 3711 & 3731 jaws, which must be able to close easily around the conductor. The jaws can be placed around the ground rod itself.

↳ **Note:** The clamp must be placed so that the jaws are in an electrical path from the system neutral or ground wire to the ground rod or rods as the circuit provides.

Select the current range “A.” Clamp onto the ground conductor and measure the ground current. The maximum current range is 30A. If the ground current exceeds 5A, ground resistance measurements are not possible.

Do not proceed further with the measurement. Instead, remove the clamp-on tester from the circuit, noting the location for maintenance, and continue to the next test location.

After noting the ground current, select the ground resistance range “Ω” and measure the resistance directly. The reading you measure with the Model 3711 & 3731 indicates the resistance not just of the rod, but also of the connection to the system neutral and all bonding connections between the neutral and the rod.

Note that in Figure 33 there is both a butt plate and a ground rod. In this type of circuit, the instrument must be placed above the bond so that both grounds are included in the test. For future reference note the date, ohms reading, current reading and point number. Replace any molding you may have removed from the conductor.

↳ **Note:** A high reading indicates one or more of the following:

- A) Poor ground rod
- B) Open ground conductor
- C) High resistance bonds on the rod or splices on the conductor; watch for buried split bolts, clamps and hammer-on connections.

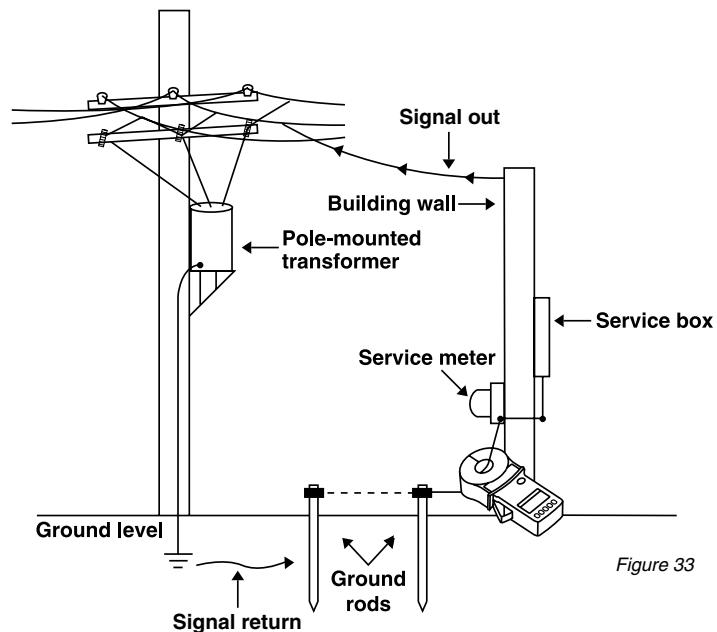
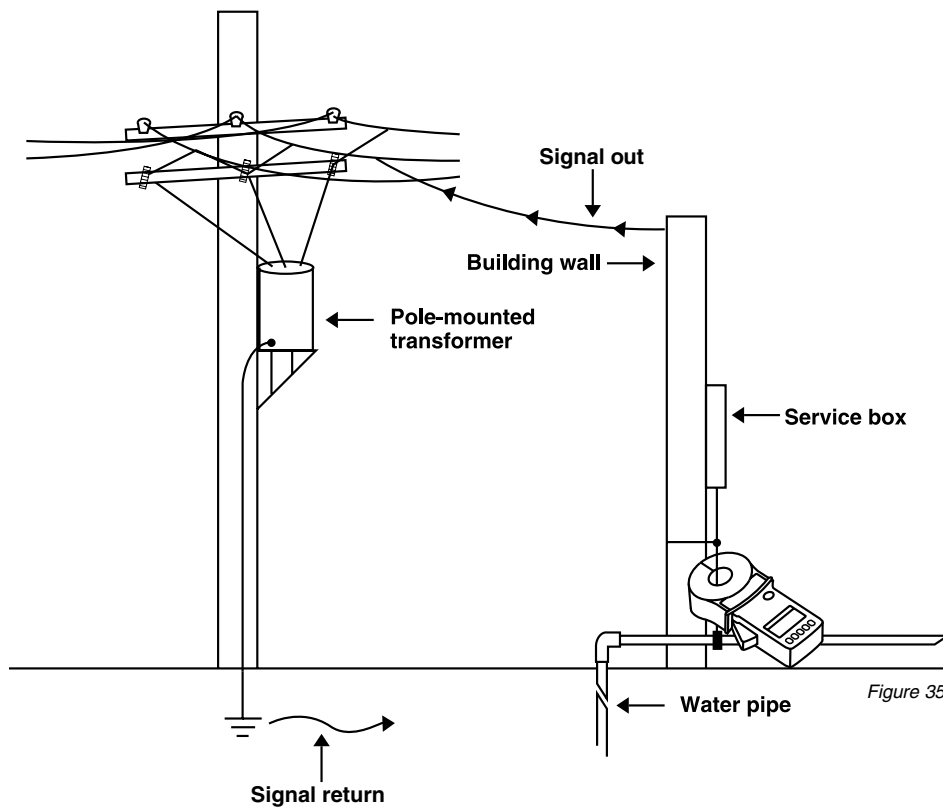
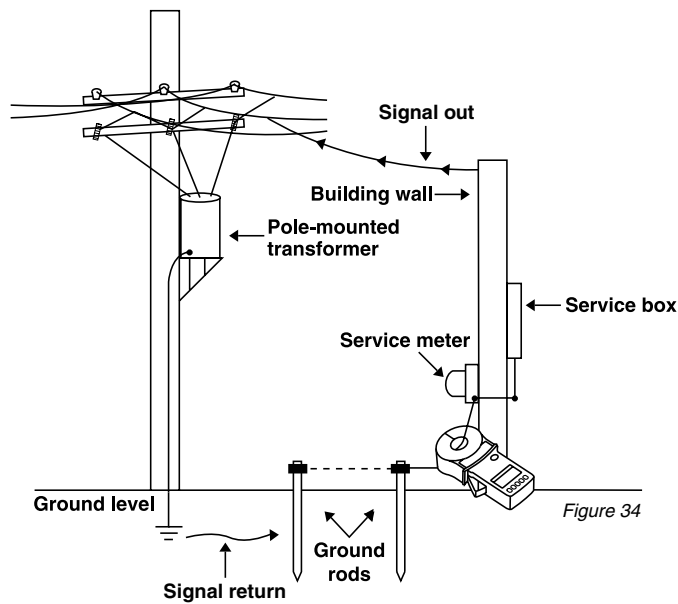

Figure 33

Service Entrance or Meter

Follow basically the same procedure as in the first example. Notice that Figure 34 shows the possibility of multiple ground rods, and in Figure 35 the ground rods have been replaced with a water pipe ground. You may also have both types acting as a ground. In these cases, it is necessary to make the measurements between the service neutral and both grounded points.



Pad Mounted Transformer

↳ **Note:** Never open transformer enclosures. They are the property of the electrical utility. This test is for high voltage experts only.

Observe all safety requirements, since dangerously high voltage is present. Locate and number all rods (usually only a single rod is present). If the ground rods are inside the enclosure, refer to Figure 36 and if they are outside the enclosure, refer to Figure 37. If a single rod is found within the enclosure, the measurement should be taken on the conductor just before the bond on the ground rod. Often, more than one ground conductor is tied to this clamp, looping back to the enclosure or neutral.

In many cases, the best reading can be obtained by clamping the Models 3711 & 3731 onto the ground rod itself, below the point when the ground conductors are attached to the rod, so that you are measuring the ground circuit. Care must be taken to find a conductor with only one return path to the neutral.

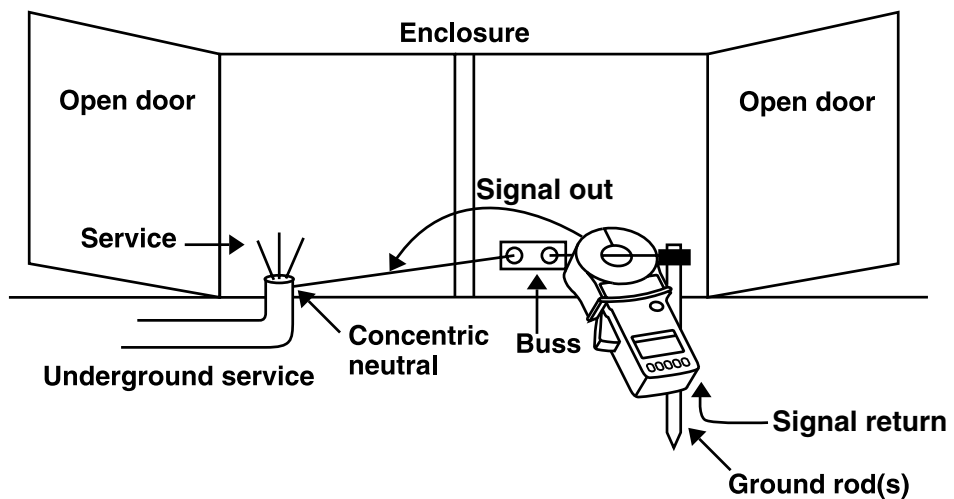

Figure 36

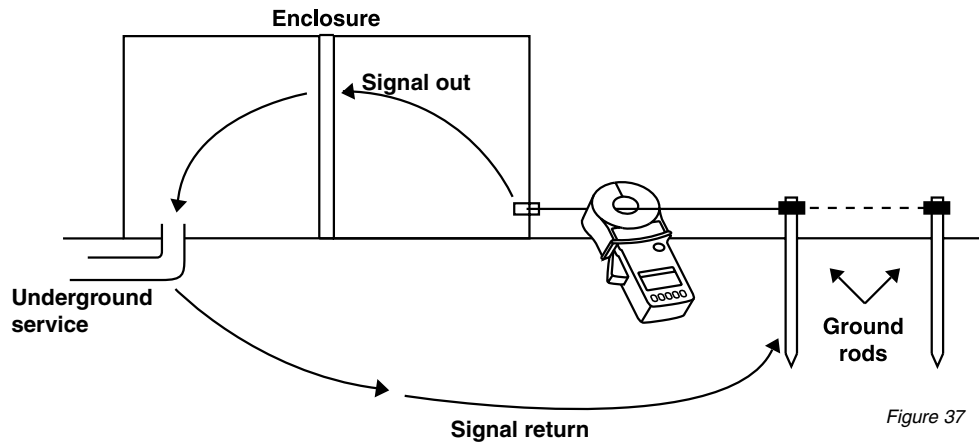

Figure 37

The clamp-on ground tester developed by AEMC® and discussed in the previous chapter has revolutionized the ability of power companies to measure their ground resistance values. This same proven instrument and technology can be applied to telephone industries to aid in detecting grounding and bonding problems. As equipment operates at lower voltages, the system's ability to remove any manmade or natural overpotentials becomes even more critical. The traditional Fall-of-Potential tester proved to be labor intensive and left much to interpretation. Even more important, the clamp-on ground test method allows the user to make this necessary reading without the risky business of removing the ground under test from service.

In many applications, the ground consists of bonding the two utilities together to avoid any difference of potentials that could be dangerous to equipment and personnel alike. The clamp-on "Ohm meter" can be used to test these important bonds.

Here are some of the solutions and clamp-on procedures that have applications to the telephone industry.

Telephone Cabinets and Enclosures

Grounding plays a very important role in the maintenance of sensitive equipment in telephone cabinets and enclosures. In order to protect this equipment, a low resistance path must be maintained in order for any overvoltage potentials to conduct safely to earth. This resistance test is performed by clamping a ground tester, Models 3711 and 3731, around the driven ground rod, below any common telephone and power company bond connections.

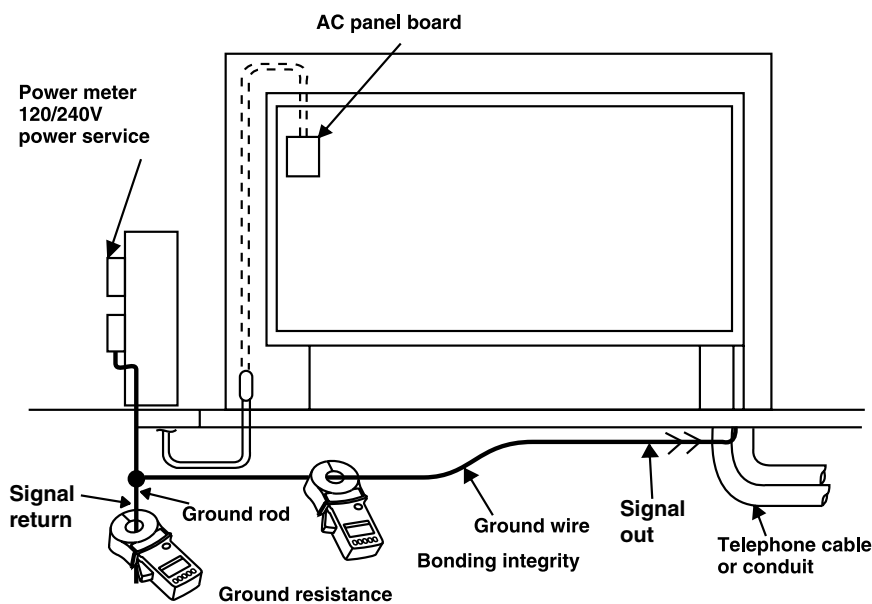

Figure 38

To avoid any high voltage potentials between the telephone and power companies, a low resistance bond is established. Bonding integrity is performed by clamping around the No. 6 copper wire between the master ground bar (MGB) and the power company's multigrounded neutral (MGN). The resistance value displayed on the tester will also include loose or poorly landed terminations that may have degraded over time.

Additionally, the clamp-on ground tester can be used as a True RMS ammeter.

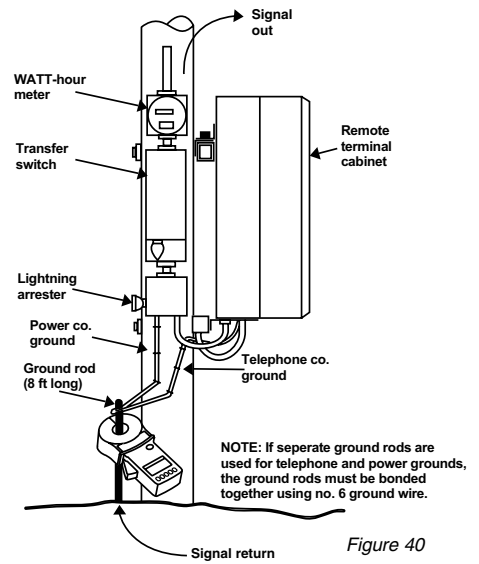

Figure 40

Pedestal Grounds

All cable sheaths are bonded to a ground bar inside each pedestal. This ground bar is connected to earth by means of a driven ground rod. The ground rod resistance can be found by using the instrument clamped around the ground rod or the No. 6 cable connecting these two points. (Figure 41)

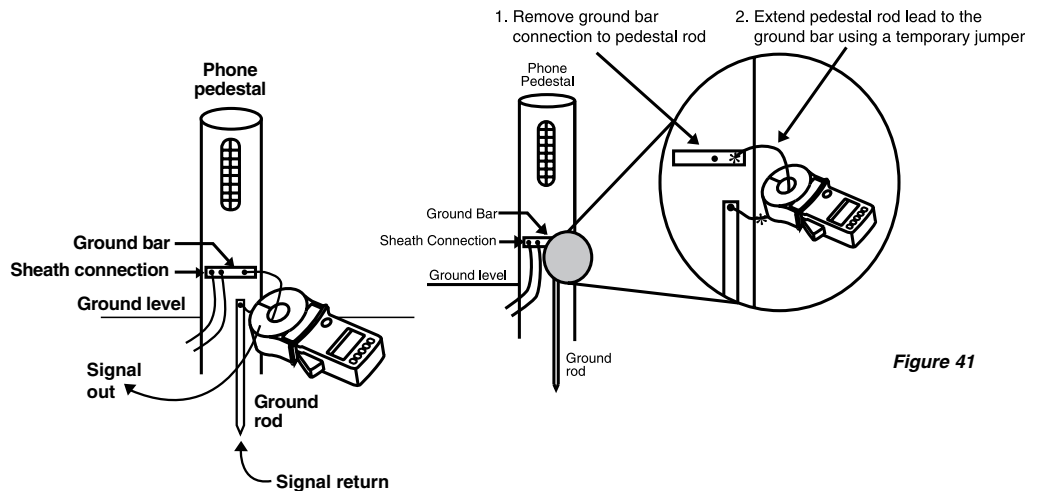

Figure 41

➡ **Note:** Temporary jumper required only if pedestal does not allow tester to fit.

Cable Shield Bonds to MGN

The cable shields in a buried or above ground telephone enclosure may be grounded by means of the power company's multigrounded neutral. The clamp-on ground tester can be utilized to ensure that this connection has been successfully terminated. The low resistance return path for the instrument to make this measurement will be from this bond wire under test to the MGN back through all other bonds up and/or down stream (theory of parallel resistance).

The clamp-on ground tester also is a True RMS ammeter.

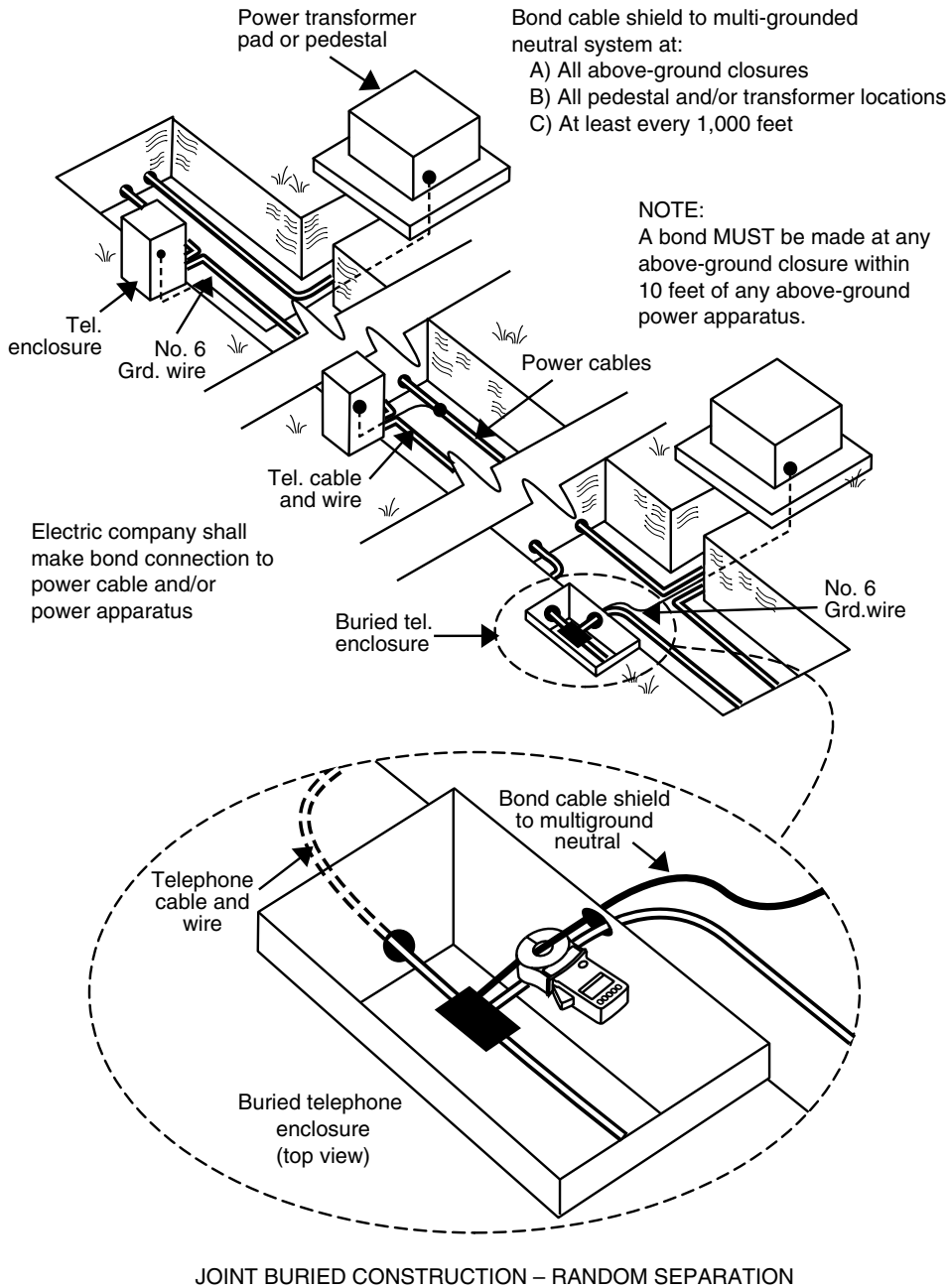

Figure 42

References

IEEE Std 81-2002

— *IEEE Guide for Measuring Earth Resistivity, Ground Impedance, and Earth Surface Potentials of Ground Systems*

IEEE Std 142-2007

— *IEEE Recommended Practice for Grounding of Industrial and Commercial Power Systems*

Blackburn/American Electric Co.

Memphis, TN 38119

— *A Modern Approach to Grounding Systems*

2008 NEC

Grounding Nomograph

Ground Rod
Resistance – Ohms

20

Soil Resistivity
(Ohm-centimeters)

11,000

Rod Length
Feet

20

Rod Diameter
Inches

5/8

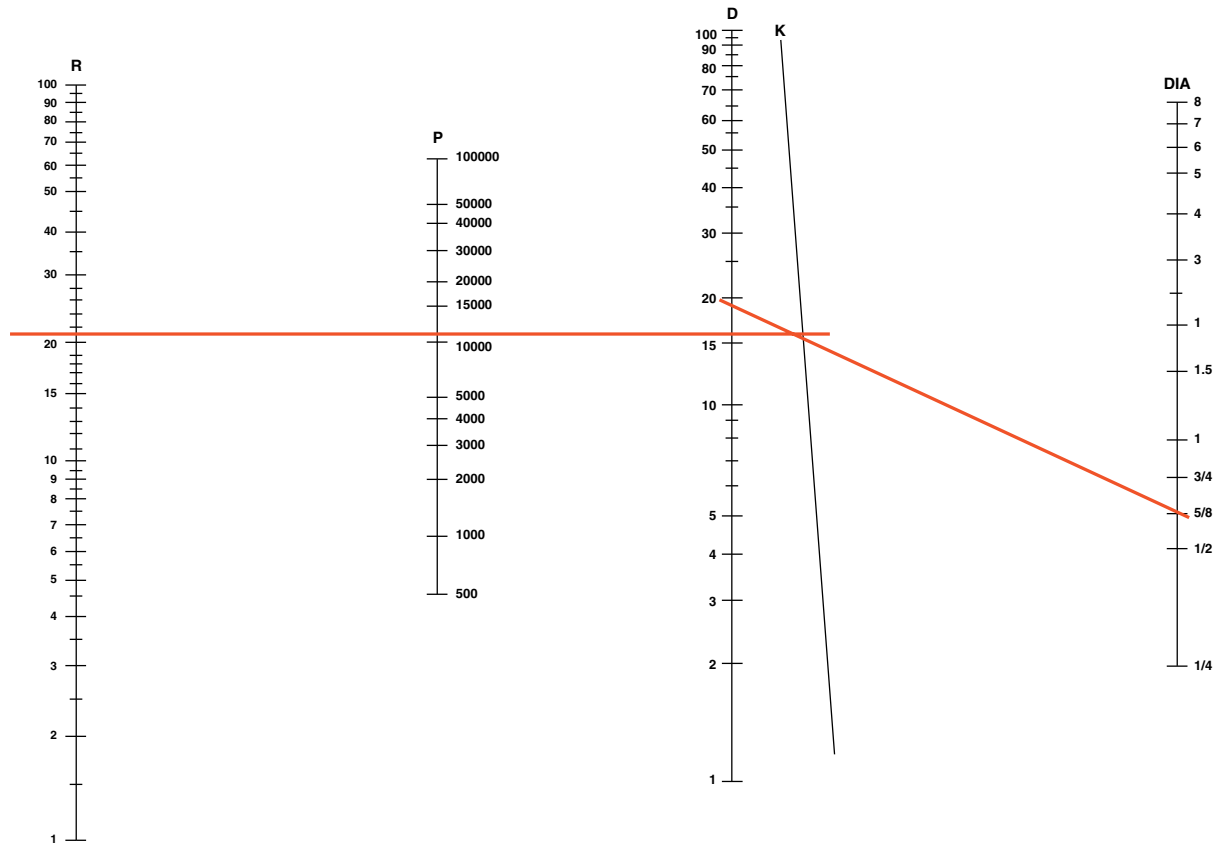

Represents example of a 20Ω, 20 ft ground rod

1. Select required resistance on R scale
2. Select apparent resistivity on P scale
3. Lay straightedge on R and P scale, and allow to intersect with K scale
4. Mark K scale point
5. Lay straightedge on K scale point and DIA scale, and allow to intersect with D scale
6. Point on D scale will be the rod depth required for resistance on R scale

Fall-of-Potential Plot

Instrument Mfr. _____ Name of Operator _____

Model _____ Location _____ Date _____

Serial # _____ Ground System Type: Single Rod Rod Depth _____ ft
 Multiple Rods (Grid) Longest Diagonal Dimension _____ ft

Z Electrode Distance _____ ft

	Voltage Electrode (Y) distance from Ground Rod under Test (X)	Measured Resistance
%	FEET	OHMS
100	_____	_____
90	_____	_____
80	_____	_____
72	_____	_____
70	_____	_____
62	_____	_____
60	_____	_____
52	_____	_____
50	_____	_____
40	_____	_____
30	_____	_____
20	_____	_____
10	_____	_____
0	_____	_____

Test Conditions				
Temp: _____		Soil: <input type="checkbox"/> Moist <input type="checkbox"/> Dry		
Soil Type				
<input type="checkbox"/> Loam	<input type="checkbox"/> Sand & Gravel	<input type="checkbox"/> Shale	<input type="checkbox"/> Clay	<input type="checkbox"/> Limestone
<input type="checkbox"/> Sandstone	<input type="checkbox"/> Granite	<input type="checkbox"/> Slate	<input type="checkbox"/> Other _____	

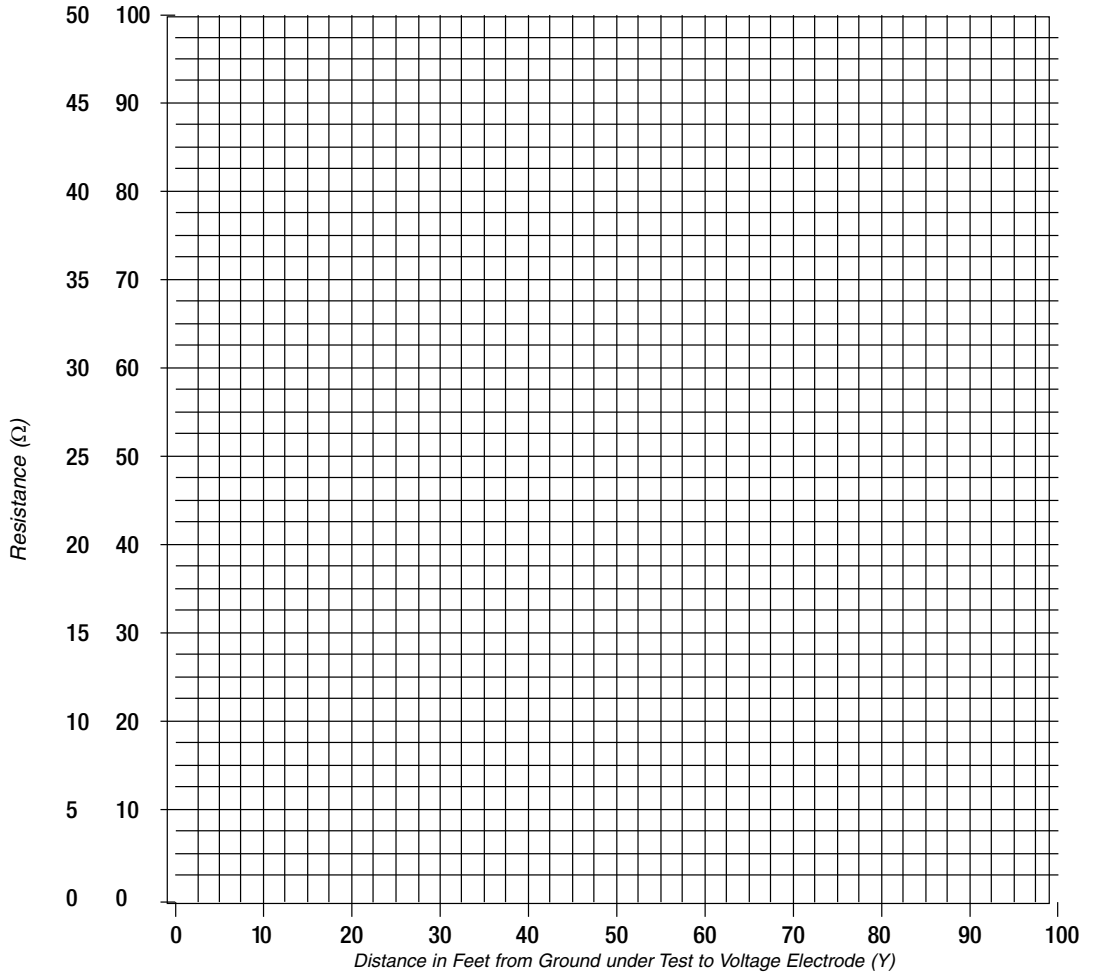

Resistance Scale:	<input type="checkbox"/> 50
	<input type="checkbox"/> 100
Multiplier:	<input type="checkbox"/> x1
	<input type="checkbox"/> x10

Distance Scale Multiplier:	<input type="checkbox"/> x1	<input type="checkbox"/> x10
----------------------------	-----------------------------	------------------------------

Ground Resistance Tester Model 6472



DataView®
Software is
included with the
Model 6472.



3-Point Test	✓
4-Point Test	Direct soil resistivity measurement
Bond Test (2- and 4-wire)	✓
Earth Coupling Test	✓
Earth Potential Measurement	✓
External Voltage Measurement	0.1 to 65.0V
Measurement Range	99,000Ω
Ranging	Auto-Ranging
Test Current	Up to 250mA
Test Frequency	Selectable from 40 to 5078Hz
Power Source	Rechargeable 9.6V NiMH battery pack
Display	Digital/backlight
Dimensions	10.7 x 9.76 x 5.12"
Weight	7.5 lbs
Catalog No.	2135.51

Also available as kits. See website.

Multi-function Ground Resistance Tester Model 6470-B



DataView®
Software is
included with the
Model 6470-B.



3-Point Test	✓
4-Point Test	Direct soil resistivity measurement
Bond Test (2- and 4-wire)	✓
Earth Coupling Test	✓
Measurement Range	99,000Ω
Ranging	Auto-Ranging
Test Current	Up to 250mA
Test Frequency	Selectable from 40 to 513Hz
Power Source	Rechargeable 9.6V NiMH battery pack
Display	Digital/backlight
Dimensions	10.7 x 9.76 x 5.12"
Weight	7.5 lbs
Catalog No.	2135.01

Also available as kits. See website.

Digital Ground Resistance Tester Model 4620 & 4630



MODELS	4620	4630
2-Point Test		✓
3-Point Test		✓
4-Point Test		✓
Measurement Range	0.00 to 1999Ω	
Ranging	Automatic	
Test Current	Auto up to 10mA	
Noise Protection	Enhanced filtering with LED indication	
Power Source	Eight C cell Alkaline batteries	Rechargeable 9.6V batteries
Display	Digital/backlight	
Dimensions	10.7 x 9.76 x 5.12"	
Weight	7.75 lbs	
Catalog No.	2130.43	2130.44

Also available as kits. See website.

Ground Resistance Tester Model 6471



AC Current Probes
Model SR182



3-Point Test	✓
4-Point Test	Direct soil resistivity measurement
Bond Test (2- and 4-wire)	✓
Earth Coupling Test	✓
External Voltage Measurement	0.1 to 65.0V
Measurement Range	99,000Ω
Ranging	Auto-Ranging
Test Current	Up to 250mA
Test Frequency	Selectable from 41 to 513Hz
Power Source	Rechargeable 9.6V NiMH battery pack
Display	Digital/backlight
Dimensions	10.7 x 9.76 x 5.12"
Weight	7.5 lbs
Catalog No.	2135.49

Also available as kit. See website.

Clamp-On Ground Resistance Testers Models 3711 & 3731



MODELS	3711	3731
Clamp-On Test		✓
Measurement Range	0.1 to 1200Ω	
Ranging	Automatic	
Current Range	1mA to 30Arms	
Test Current	Automatic	
Noise Protection	Enhanced filtering	
Other Features	Hold function	Alarm & memory
Power Source	9V Alkaline	
Display	Digital	
Dimensions	9.25 x 3.94 x 2.17"	
Weight	2.2 lbs	
Catalog No.	2117.60	2117.61

10A Micro-Ohmmeter Model 6240



DataView®
Software is
included with the
Model 6240.



4-Point, Kelvin Bridge	✓
Measurement Range	5μΩ to 400Ω
Test Current	10mA to 10A selectable
Resolution	1μΩ to 100mΩ
Temperature Correction	Manual
Power Source	Rechargeable NiMH 6V battery
Display	Digital/Backlit
Dimensions	10.7 x 9.76 x 7.17"
Weight	9.9 lbs
Catalog No.	2129.80

Accessory 1A and 10A Kelvin Probes available.



Find us on the **WEB** at

WWW
AEMC
.COM

AEMC® Website

The AEMC® website offers a wide assortment of technical product information, software and firmware updates, user manuals and printable data sheets for all AEMC® products. View AEMC®'s upcoming trade shows and training seminars that take place across the country, read about AEMC®'s NEW products and register purchased AEMC® products. Visit us at www.aemc.com

AEMC® Storefront

The AEMC® online store offers the opportunity to purchase replacement parts such as fuses, test leads and other accessory items for your test instruments. The online store also offers refurbished and discontinued items at a reduced price. Product specials are also offered.

Visit the store at www.aemc.com/store

Technical Sales and Assistance

If you are experiencing any technical problems, or require any assistance with the proper use or application of any AEMC® instrument, contact our technical hotline at techsupport@aemc.com or call (800) 343-1391

AEMC ONE SOURCE®
For All Your Electrical Test & Measurement Instruments

Workbook Edition 12.0
950.WKBK-GROUND 08/11