

User Manual

Tektronix

YBT250

**NetTek® Field Transmitter &
Interference Tester**

071-0856-09

This document supports firmware version 1.4xx
and above.

www.tektronix.com

Copyright © Tektronix, Inc. All rights reserved.

Tektronix products are covered by U.S. and foreign patents, issued and pending. Information in this publication supercedes that in all previously published material. Specifications and price change privileges reserved.

Tektronix, Inc., P.O. Box 500, Beaverton, OR 97077

TEKTRONIX, TEK, and NETTEK are registered trademarks of Tektronix, Inc.

WARRANTY

Tektronix warrants that the products that it manufactures and sells will be free from defects in materials and workmanship for a period of one (1) year from the date of purchase from an authorized Tektronix distributor. If any such product proves defective during this warranty period, Tektronix, at its option, either will repair the defective product without charge for parts and labor, or will provide a replacement in exchange for the defective product. Batteries are excluded from this warranty.

In order to obtain service under this warranty, Customer must notify Tektronix of the defect before the expiration of the warranty period and make suitable arrangements for the performance of service. Customer shall be responsible for packaging and shipping the defective product to the service center designated by Tektronix, shipping charges prepaid, and with a copy of customer proof of purchase. Tektronix shall pay for the return of the product to Customer if the shipment is to a location within the country in which the Tektronix service center is located. Customer shall be responsible for paying all shipping charges, duties, taxes, and any other charges for products returned to any other locations.

This warranty shall not apply to any defect, failure or damage caused by improper use or improper or inadequate maintenance and care. Tektronix shall not be obligated to furnish service under this warranty a) to repair damage resulting from attempts by personnel other than Tektronix representatives to install, repair or service the product; b) to repair damage resulting from improper use or connection to incompatible equipment; c) to repair any damage or malfunction caused by the use of non-Tektronix supplies; or d) to service a product that has been modified or integrated with other products when the effect of such modification or integration increases the time or difficulty of servicing the product.

THIS WARRANTY IS GIVEN BY TEKTRONIX WITH RESPECT TO THE LISTED PRODUCTS IN LIEU OF ANY OTHER WARRANTIES, EXPRESS OR IMPLIED. TEKTRONIX AND ITS VENDORS DISCLAIM ANY IMPLIED WARRANTIES OF MERCHANTABILITY OR FITNESS FOR A PARTICULAR PURPOSE. TEKTRONIX' RESPONSIBILITY TO REPAIR OR REPLACE DEFECTIVE PRODUCTS IS THE SOLE AND EXCLUSIVE REMEDY PROVIDED TO THE CUSTOMER FOR BREACH OF THIS WARRANTY. TEKTRONIX AND ITS VENDORS WILL NOT BE LIABLE FOR ANY INDIRECT, SPECIAL, INCIDENTAL, OR CONSEQUENTIAL DAMAGES IRRESPECTIVE OF WHETHER TEKTRONIX OR THE VENDOR HAS ADVANCE NOTICE OF THE POSSIBILITY OF SUCH DAMAGES.

Table of Contents

| | |
|-------------------------------------|-------------|
| General Safety Summary | ix |
| Preface | xiii |
| About this Manual | xiii |
| Additional Information | xiv |
| Conventions | xiv |
| Software Version | xiv |
| Contacting Tektronix | xv |

Getting Started

| | |
|---|------|
| Product Description | 1-1 |
| Standard Accessories | 1-3 |
| Installing a YBT250 Module | 1-3 |
| Removing a YBT250 Module | 1-6 |
| The NetTek Analyzer Platform Battery | 1-7 |
| Installing the Battery | 1-7 |
| Removing a Battery | 1-10 |
| Charging a Battery | 1-11 |
| Optimizing Battery Life | 1-12 |
| Transporting Lithium-Ion Batteries | 1-12 |
| Connecting External Power Supplies | 1-13 |
| Setting Up the Tilt Stand | 1-14 |
| Installing the Shoulder Strap and Strand Hook | 1-16 |
| Powering On the Instrument | 1-17 |
| How the Software Loads | 1-17 |
| Calibrating the Touch-Screen Display | 1-18 |
| Setting the stylus sensitivity | 1-18 |
| Setting the stylus centering | 1-18 |
| Powering Off the Instrument | 1-18 |
| Suspend Mode | 1-18 |
| Shutdown | 1-19 |
| Restart (Software Reset) | 1-19 |
| Front-Panel Power Switch | 1-20 |

| | |
|---|------|
| Preventing Personal Injury from the Effects of Lightning | 1-20 |
| Before connecting this product to any source | 1-20 |
| Do not connect this product to any source which might be subject to the effects of lightning | 1-21 |
| Be alert and aware of the effects of lightning | 1-21 |

Operating Basics

| | |
|---|-------------|
| Overview | 2-1 |
| Identifying Front-Panel Controls and Indicators | 2-2 |
| YBT250 Inputs | 2-3 |
| Getting Help | 2-4 |
| Navigating the Desktop | 2-5 |
| Icons | 2-6 |
| Taskbar | 2-6 |
| Starting the YBT250 Software | 2-8 |
| Setting the YBT250 Software to Load at Startup | 2-9 |
| Elements of the Display | 2-10 |
| Shared Control Area | 2-11 |
| Command Bar Area | 2-12 |
| Tuning Control Area | 2-13 |
| Instrument Area | 2-14 |
| Using the Touch Screen | 2-14 |
| Using the Knob | 2-14 |
| Using the Numeric Keypad | 2-14 |
| YBT250 Menus | 2-15 |
| Entering Text | 2-20 |
| Powering Off the YBT250 | 2-21 |
| Suspend Mode | 2-21 |
| Shutdown | 2-22 |
| Restart (Software Reset) | 2-22 |
| Connecting a Signal | 2-23 |
| RF Signal Input Parameters | 2-23 |
| Connecting an RF Signal | 2-24 |
| Connecting a Timing Reference (cdmaOne/cdma2000 /1xEV-DO Only) | 2-26 |
| Connecting an External Frequency Reference | 2-26 |
| Improving Frequency Accuracy | 2-29 |

| | |
|---|-------------|
| Changing Instrument Settings | 2-33 |
| Enabling Signal Standards | 2-33 |
| Setting Display Preferences | 2-35 |
| Setting Up the Channel Table | 2-36 |
| Customizing the Channel Table | 2-40 |
| Creating a Custom Channel Table | 2-41 |
| Specifying the Signal Type | 2-44 |
| How Channel Frequencies are Calculated | 2-44 |
| Changing Settings for Saved Files | 2-45 |
| Where to Set File Options | 2-45 |
| Setting the Filename Prefix | 2-46 |
| Setting the Technician Name | 2-47 |
| Entering Notes for Saved Results | 2-47 |
| Setting Up a GPS Receiver | 2-48 |
| Setting Default File Type | 2-48 |
| Setting Default File Location for Automatically Saving and Exporting Spectrograms and Codograms .. | 2-49 |
| Saving GPS Coordinates with your Results | 2-50 |
| Selecting a Compatible GPS Receiver | 2-50 |
| Enabling Your GPS Receiver | 2-50 |
| Troubleshooting Your GPS Receiver | 2-51 |
| vxHpc Software | 2-52 |

Reference

| | |
|---|------------|
| Displaying a Signal Spectrum | 3-1 |
| The Spectrum Display Area | 3-1 |
| Displaying a Trace | 3-5 |
| Setting Trace Display Options | 3-6 |
| Setting the Trace Type | 3-7 |
| Changing the Vertical Scale of the Spectrum Display | 3-9 |
| Changing the Vertical Position of the Trace | 3-10 |
| Changing the Horizontal Position of the Trace | 3-10 |
| Changing the Reference Level | 3-11 |
| Disabling Tap/Drag Operation | 3-11 |
| Saving Traces | 3-12 |
| Displaying a Saved Trace | 3-13 |
| Comparing Traces | 3-13 |
| Defining Trace 2 | 3-13 |
| Comparing Two Trace Results Files | 3-15 |

| | |
|---|-------------|
| Displaying Markers | 3-17 |
| Specifying Units for Marker Display | 3-19 |
| Measuring Frequency and Level Differences on a Single Trace | 3-20 |
| Measuring Frequency and Level Differences Between Two Traces | 3-21 |
| Markers and Mask Testing | 3-22 |
| Band Edge Cursor | 3-22 |
| Displaying a Spectrogram | 3-24 |
| Setting the Spectrogram Update Rate | 3-25 |
| Automatically Saving and Exporting the Spectrogram Display | 3-26 |
| Creating a Mask | 3-27 |
| Defining a Mask | 3-32 |
| Performing a Mask Test | 3-33 |
| Mask Testing and Markers | 3-33 |
| Locating Interference | 3-35 |
| The Interference Display Area | 3-35 |
| Displaying a Trace | 3-37 |
| Identifying a Signal | 3-38 |
| Locating an Interfering Signal | 3-39 |
| Demodulating an Interfering Signal | 3-41 |
| Measuring the Noise Floor | 3-43 |
| Locating Intermittent Interference | 3-44 |
| Analyzing W-CDMA Scrambling Codes | 3-47 |
| W-CDMA Scrambling Code Results | 3-48 |
| Sorting or Locking the Current Set of Scrambling Codes .. | 3-48 |
| Taking Measurements | 3-51 |
| The Measure Window Display | 3-51 |
| Setting the Measurement Frequency | 3-52 |
| What Measurements are Available | 3-55 |

| | |
|---|------|
| Limit Testing | 3-55 |
| Analog Limit Test Measurements | 3-56 |
| cdmaOne/cdma2000 Limit Test Measurements | 3-56 |
| GSM Limit Test Measurements | 3-56 |
| GSM/EDGE Limit Test Measurements | 3-57 |
| NADC IS-136 Limit Test Measurements | 3-57 |
| W-CDMA Limit Test Measurements | 3-57 |
| cdma2k 1xEV-DO Limit Test Measurements | 3-58 |
| Enabling Limit Testing | 3-59 |
| Setting the Scrambling Code Detection | 3-61 |
| Changing the Setting | 3-62 |
| How the Scrambling Code Setting is Indicated in Displays | 3-63 |
| Measuring RF Power | 3-63 |
| Measuring GSM/EDGE RF Power | 3-65 |
| Setting GSM/EDGE BCCH Frame Sync Modes | 3-67 |
| Channel and Frequency Setting Interactions | 3-70 |
| Setting GSM/EDGE RF Channel Power Modes | 3-70 |
| Measuring cdma2000 1xEV-DO RF Power | 3-72 |
| 1xEV-DO Transmission Envelopes on the RF Power Screen | 3-74 |
| Measuring GSM/EDGE Power vs Time | 3-76 |
| Setting GSM/EDGE Power vs Time parameters | 3-79 |
| Measuring Peak to Average Power Ratio | 3-80 |
| Measuring Carrier Frequency | 3-81 |
| Measuring Occupied Bandwidth | 3-83 |
| Measuring cdmaOne and cdma2000 Signal Quality | 3-85 |
| Measuring W-CDMA Signal Quality | 3-86 |
| Measuring cdma2k 1xEV-DO Signal Quality | 3-88 |
| Waveform Quality (Rho) | 3-90 |
| Error Vector Magnitude (EVM) | 3-90 |
| Data Constellation Type | 3-90 |
| PN Offset | 3-91 |
| Pilot Time Alignment Error (Tau) | 3-91 |
| Measuring GSM/EDGE Signal Quality | 3-91 |
| Phase Error | 3-93 |
| Error Vector Magnitude (EVM) | 3-93 |
| Origin Offset | 3-93 |
| Carrier to Interference Ratio (C/I) | 3-93 |

| | |
|---|--------------|
| Measuring cdmaOne Code Power | 3-93 |
| Measuring cdma2000 Code Power | 3-95 |
| Code Domain Power Readouts | 3-97 |
| Measuring W-CDMA Code Power | 3-98 |
| Code Domain Power Readouts | 3-100 |
| Measuring cdma2k 1xEV-DO Code Power | 3-101 |
| Code Domain Power Readouts | 3-103 |
| Displaying a cdmaOne Codogram | 3-104 |
| Displaying a cdma2000 Codogram | 3-106 |
| Displaying a W-CDMA Codogram | 3-108 |
| Displaying a cdma2k 1xEV-DO Codogram | 3-110 |
| Automatically Saving the cdmaOne, cdma2000, 1xEV-DO, and W-CDMA Codogram Displays | 3-112 |
| Measuring cdmaOne and cdma2000 Pilot Power | 3-115 |
| Measuring W-CDMA Pilot Power and Sync Powers | 3-117 |
| Measuring W-CDMA ACLR | 3-118 |
| Taking and Displaying Multiple Measurements at Once Using the Sequencer (Button 4) | 3-119 |
| Saving, Exporting, and Recalling Results, Traces, and Settings | 3-123 |
| Saving Measurement Results | 3-124 |
| What is Saved in a Measurement Results File | 3-124 |
| Recalling Measurement Results | 3-125 |
| Exporting Measurement Results | 3-127 |
| Exporting a Screen | 3-128 |
| Saving a Trace | 3-129 |
| Recalling a Trace | 3-130 |
| Exporting a Trace | 3-131 |
| Differences Between Exported Screens and Traces | 3-131 |
| Saving Setups | 3-133 |
| Recalling Setups | 3-134 |
| Customizing the Setup menu | 3-135 |
| Preventing Changes to Saved Setups | 3-135 |
| Enabling Changes to Saved Setups | 3-136 |
| Specifying the List of Saved Setups | 3-136 |

Appendices

| | |
|---|------------|
| Appendix A: Specifications | A-1 |
| Appendix B: Accessories | B-1 |
| Standard Accessories | B-1 |
| Optional Accessories | B-2 |
| Appendix C: Options | C-1 |
| Appendix D: Installing Options and Upgrading Software .. | D-1 |
| Before Installing Options | D-1 |
| Installing Options | D-2 |
| Upgrading/Reinstalling the YBT250 Software | D-5 |
| Appendix E: Functional Verification Procedure | E-1 |
| Self Tests | E-1 |
| Equipment Required | E-1 |
| Prerequisite | E-1 |
| Functional Tests | E-3 |
| Equipment Required | E-3 |
| Prerequisite | E-3 |
| Section 1: Check RF attenuation | E-3 |
| Section 2: External Reference | E-4 |
| Appendix F: Supported Signal Standards | F-1 |
| Appendix G: Channel Table | G-1 |
| About the Signal Type | G-1 |

Glossary

Index

General Safety Summary

Review the following safety precautions to avoid injury and prevent damage to this product or any products connected to it. To avoid potential hazards, use this product only as specified.

Only qualified personnel should perform service procedures.

While using this product, you may need to access other parts of the system. Read the *General Safety Summary* in other system manuals for warnings and cautions related to operating the system.



WARNING. *Do not connect to any source which may be subject to the effects of lightning.*

To Avoid Fire or Personal Injury

Use Proper Power Cord. Use only the power cord specified for this product and certified for the country of use.

Connect and Disconnect Properly. Do not connect or disconnect probes or test leads while they are connected to a voltage source.

Observe All Terminal Ratings. To avoid fire or shock hazard, observe all ratings and markings on the product. Consult the product manual for further ratings information before making connections to the product.

The common terminal is at ground potential. Do not connect the common terminal to elevated voltages.

Replace Batteries Properly. Replace batteries only with the proper type and rating specified.

Recharge Batteries Properly. Recharge batteries only as specified.

Use Proper AC Adapter. Use only the AC adapter specified for this product.

Do Not Operate Without Covers. Do not operate this product with covers or panels removed.

Wear Eye Protection. Wear eye protection if exposure to high-intensity rays or laser radiation exists.

Do Not Operate With Suspected Failures. If you suspect there is damage to this product, have it inspected by qualified service personnel.

Do Not Operate in an Explosive Atmosphere.

Safety Terms and Symbols

Terms in This Manual. These terms may appear in this manual:



WARNING. *Warning statements identify conditions or practices that could result in injury or loss of life.*



CAUTION. *Caution statements identify conditions or practices that could result in damage to this product or other property.*

Terms on the Product. These terms may appear on the product:

DANGER indicates an injury hazard immediately accessible as you read the marking.

WARNING indicates an injury hazard not immediately accessible as you read the marking.

CAUTION indicates a hazard to property including the product.

Symbols on the Product. These symbols may appear on the product:



CAUTION
Refer to Manual

Battery Recycling

This product contains a Lithium Ion battery, which must be recycled or disposed of properly. For the location of a local battery recycler in the U.S. or Canada, please contact:

RBRC
Rechargeable Battery Recycling Corp.
P.O. Box 141870
Gainesville, Florida 32614

(800) BATTERY
(800) 227-7379
www.rbrc.com



Preface

The YBT250 Field Transmitter & Interference Tester is part of the NetTek Base Transceiver Station (BTS) Field Tool family: a high performance, portable, field-ready tester optimized for fast trouble resolution and easy BTS performance verification. It is based on the familiar and easy-to-use Windows CE operating system, so you will spend less time learning the instrument and more time troubleshooting the network.

The YBT250 verifies the most important RF transmit functions of cdmaOne/cdma2000/1xEV-DO, TDMA IS-136, GSM/EDGE, W-CDMA (UMTS), and Analog base stations. The YBT250 Field Transmitter & Interference Tester has powerful analysis tools to enable you to locate and identify interfering signals quickly. With its built-in spectrum analysis display, the YBT250 enables you to easily see signal problems. The spectrogram display makes it easier than ever to spot intermittent signal problems.

About this Manual

This manual is divided into four sections: *Getting Started*, *Operating Basics*, *Reference*, and *Appendices*.

The *Getting Started* section describes how to start using your YBT250 Field Transmitter & Interference Tester.

The *Operating Basics* section shows you how to operate the YBT250.

The *Reference* section explains how to perform specific tests with the YBT250.

The *Appendices* contain reference information such as specifications, a functional verification procedure, and other information that you might need occasionally.

Additional Information

The YBT250 Field Transmitter & Interference Tester contains online help to enable you to quickly get explanations of how to use your YBT250. The online help is the first place you should look for information about operating the YBT250.

The YBT250 Field Transmitter & Interference Tester is based on the NetTek Analyzer Platform. Important information about configuring and operating the NetTek Analyzer Platform is contained in the *Getting Started* section of this manual. There is also extensive online help available on the NetTek Analyzer Platform.

Conventions

This manual uses the following convention. The statement **Start > Help** is requesting that you open the Start menu and select Help. To do this, tap the Start button in the toolbar at the bottom of the desktop window; then tap Help in the resulting menu.

Software Version

This manual supports YBT250 Field Transmitter & Interference Testers running software version 1.4xx. To verify your software version, select **Tools > Software Info** when the YBT250 is running.

Contacting Tektronix

| | |
|--------------------------|---|
| Phone | 1-800-833-9200* |
| Address | Tektronix, Inc. Department or name (if known) 14200 SW Karl Braun Drive P.O. Box 500 Beaverton, OR 97077 USA |
| Web site | www.tektronix.com |
| Sales support | 1-800-833-9200, select option 1* |
| Service support | 1-800-833-9200, select option 2* |
| Technical support | Email: techsupport@tektronix.com 1-800-833-9200, select option 3* 6:00 a.m. - 5:00 p.m. Pacific time |

* **This phone number is toll free in North America. After office hours, please leave a voice mail message. Outside North America, contact a Tektronix sales office or distributor; see the Tektronix web site for a list of offices.**



Getting Started

Getting Started

This section contains a description of the YBT250 Field Transmitter & Interference Tester and basic information you need to start using your module.

Product Description

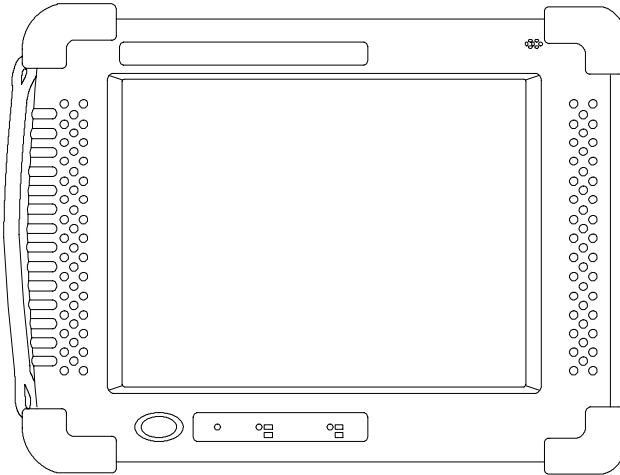

Figure 1-1: YBT250 Field Transmitter & Interference Tester

The YBT250 Field Transmitter & Interference Tester is an RF tester optimized for field testing cellular basestations. The YBT250 is a modular test instrument based on the NetTek Analyzer Platform. The standard YBT250 actually consists of two parts: the instrument module and the NetTek Analyzer Platform.

The instrument module contains the hardware and software that does the RF analysis. The YBT250 can also be purchased as just an instrument module that can be added to a NetTek Analyzer Platform that you already have.

You can attach up to three instrument modules onto the NetTek Analyzer Platform to expand the instrument's test capabilities. Instrument modules communicate with the platform through the internal bus and to the Base Station or device under test through their own input and output connectors.

The NetTek Analyzer Platform is the “computer” that runs the instrument module software, and is based on the Windows CE operating system.

NetTek Analyzer Platform product features include the following:





- Display with touchscreen interface
- Ruggedized package
- Removable battery packs
- I/O ports
- Software applications and utilities that support communications, power management, instrument configuration, text editing, web browsing, and more.

Standard Accessories

The tables below provide a list of the standard accessories supplied with the YBT250 Module.

For a complete list of standard and optional accessories, see *Appendix B*, beginning on page B-1.

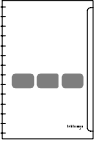
Table 1-1: Standard module accessories

| | |
|---|--|
|  | N Connector Plastic Cover. Used to protect the RF Input connector. |
|  | BNC Plastic Cover. Used to protect the External Timing and Frequency Reference Inputs. |
|  | User Manual. Contains information on setup, basic operations, and taking measurements. |
|  | CD-ROM. Contains instrument software and an Adobe Acrobat PDF version of the user manual. |

Installing a YBT250 Module

If you purchased a YBT250 module for use on a NetTek Analyzer Platform you already have, use the following procedure to install a YBT250 module onto the NetTek Analyzer Platform or to attach a YBT250 module onto another module.



CAUTION. *To prevent damage to the NetTek Analyzer Platform or YBT250 module, you must power down the NetTek Analyzer Platform before installing a YBT250 module.*

Use the following procedure to install a YBT250 module on a NetTek Analyzer Platform:

1. Select **Start > Shutdown**.
2. In the Shut Down dialog box, select **Shutdown**.
3. Disconnect all cables to the NetTek Analyzer Platform.
4. Place the NetTek Analyzer Platform face down on a flat uncluttered surface. The NetTek Analyzer Platform should be supported only by its four corner bumpers.
5. Remove the bus door from the rear of the NetTek Analyzer Platform or instrument module. See Figure 1-2.

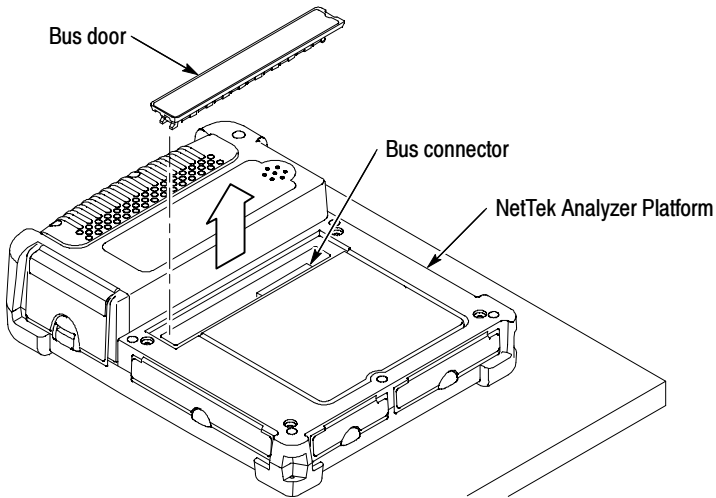

Figure 1-2: Removing the bus door

6. Carefully lower the YBT250 module onto the NetTek Analyzer Platform to engage the bus connectors. See Figure 1-3.

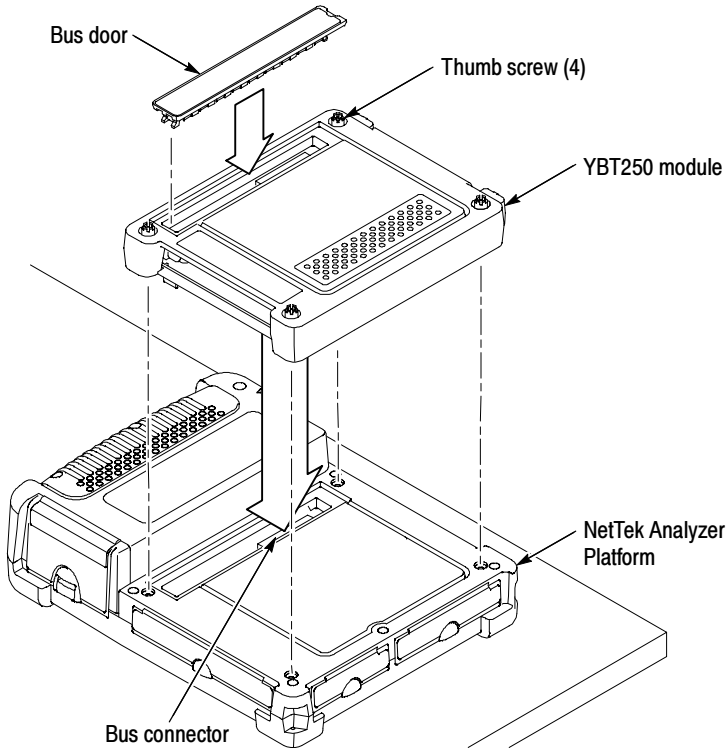

Figure 1-3: Attaching the YBT250 module

7. Press down firmly to seat the connector and ensure contact.
8. Locate the thumb screws. See Figure 1-3.
9. For each thumb screw, push down on the head and turn it 1/4 turn in a counter-clockwise direction and let it pop up to extend the length.
10. Tighten the screws by pressing in just slightly and turning them in a clockwise direction. Use the coin slot in the top of the thumb screw if you require additional torque. Be sure to tighten all screws evenly, but do not overtighten.

11. To recess the thumb screw heads, push and turn each screw head 1/4 turn in a clockwise direction.
12. To maintain the enclosure seal integrity, reinstall the bus door into the rear of the YBT250 module.

Removing a YBT250 Module

Use the following procedure to remove a YBT250 module from a NetTek Analyzer Platform:

1. Select **Start > Shutdown** to shut down the NetTek Analyzer Platform.
2. Disconnect all cables to the NetTek Analyzer Platform.
3. Place the NetTek Analyzer Platform face down on a flat uncluttered surface. The NetTek Analyzer Platform should be supported only by its four corner bumpers.
4. To release the thumb-screw heads, push and turn each screw head 1/4 turn in a counter-clockwise direction.
5. Disengage all four screws by turning them in a counter clockwise direction. A tool or coin may be required if the screws were tightened with a coin or other tool.
6. Pull up on the YBT250 module to remove it.
7. To maintain enclosure seal integrity, reinstall the bus door into the rear of the NetTek Analyzer Platform.

The NetTek Analyzer Platform Battery

The NetTek Analyzer Platform ships from the factory with the lithium-ion battery uninstalled. To operate the YBT250 from battery power, use the following procedures to install, remove, and charge the battery.

Installing a Battery

Use the following procedure to install a battery.

NOTE. See *Charging a Battery on page 1-11* before using the NetTek Analyzer Platform on battery power for the first time.

The NetTek Analyzer Platform comes standard with a single lithium-ion battery. You can add a second battery to increase the operating time. Replace a battery with the correct type only. Contact Tektronix customer support to purchase a battery.

1. Place the NetTek Analyzer Platform on a flat surface with the touch-screen display facing towards you. See Figure 1-4.

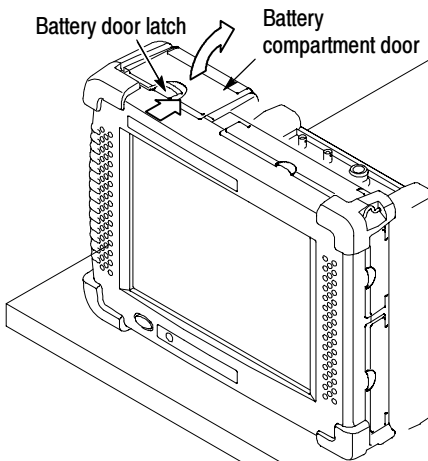

Figure 1-4: NetTek Analyzer Platform battery compartment

2. Push the battery door latch towards the rear of the analyzer and open the battery compartment door.
3. Locate the battery retainer and battery retainer tab. (See Figure 1-5.)
4. Push down on the retainer tab with your finger to release the battery retainer.
5. Lift up the battery retainer and rotate it towards the rear of the analyzer. You must hold the retainer out of the way to install the battery.

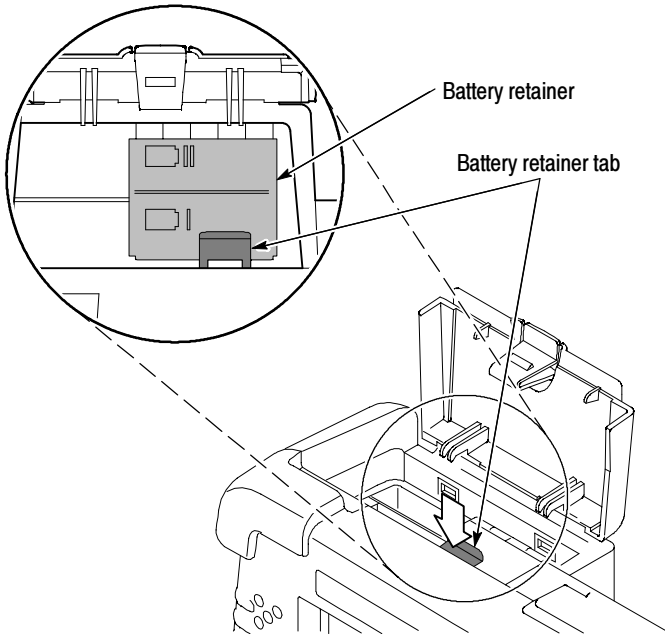

Figure 1-5: Battery retainer tab

6. Position the battery as shown in Figure 1-6. The battery electrical contacts, on the bottom of the battery, must face in the direction shown in Figure 1-6.

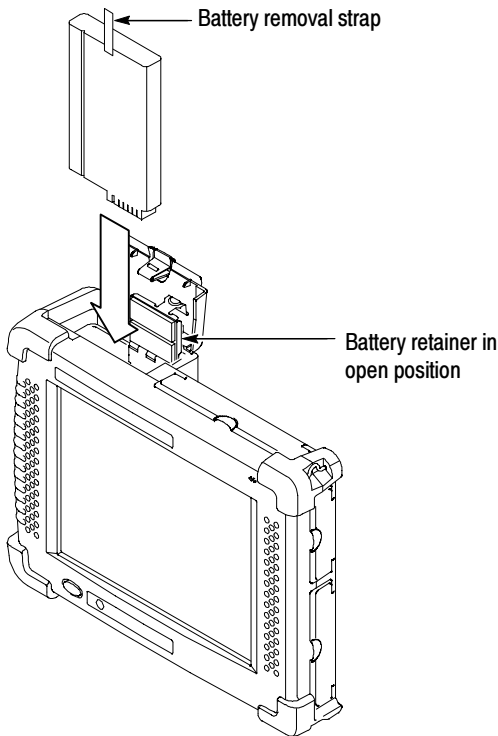

Figure 1-6: Installing a battery

7. Lower the battery into the battery compartment and apply firm pressure to seat its electrical contacts.
8. Close the battery retainer, then press down until you hear the battery retainer tab click.
9. Close and latch the battery compartment door.

Removing a Battery

Use the following procedure to remove a battery for external charging or replacement:

1. Power off the NetTek Analyzer Platform and disconnect any test cables.
2. Place the NetTek Analyzer Platform on a flat surface with the touch-screen display facing towards you and the battery compartment door facing up. See Figure 1-6 for component locations.
3. Push the battery compartment door latch towards the rear of the NetTek Analyzer Platform and open the battery compartment door.
4. Push down and back on the battery retainer tab to release the battery retainer.
5. Lift up the battery retainer and rotate it towards the rear of the instrument. You must hold the retainer out of the way to remove a battery.
6. Locate the battery removal strap located on the top of the battery.
7. Pull up on the battery removal strap to remove the battery. See Figure 1-7. If the strap is not accessible, place your hand over the battery compartment and tilt the NetTek Analyzer Platform upside down. The battery should come out of the compartment. Be careful to not to drop the battery.
8. Follow the procedure on page 1-9, steps 6 through 9,, to install a new or freshly charged battery.

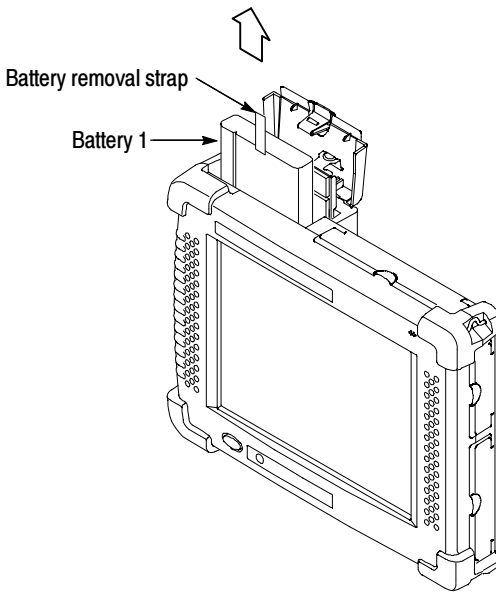

Figure 1-7: Removing a battery

Charging a Battery

NetTek Analyzer Platform batteries are calibrated and partially charged at the factory. When batteries are calibrated, the NetTek Analyzer Platform can provide an estimate of how much longer the YBT250 can operate before the instrument automatically powers off. The YBT250 always warns you before powering off, so that you can save important test results or settings.

NOTE. *To achieve optimum performance from a new battery, fully charge the battery. Then fully discharge the battery by leaving the YBT250 running (see Start > Help > Settings > Power Management for information on how to disable the power saver function). Finally, fully charge the battery again.*

To verify the battery charge status at any time:

1. Select **Start > Settings > Control Panel**.
2. Open (double-tap) the Power Management icon. The **Batteries** tab lists the status of each battery.

If the battery charge is low, recharge the battery or batteries as follows:

1. Select **Start > Shutdown** to shut down the NetTek Analyzer Platform.
2. Disconnect all cables to the NetTek Analyzer Platform.
3. Connect the Desktop power supply as shown in Figure 1-8.
4. Plug the Desktop power supply into an 110-240 VAC power source. The front-panel Batteries indicator should glow green.
5. Let the battery charge for eight hours.

Optimizing Battery Life

For tips on how to maximize battery operating time, as well as other battery-related topics, refer to the NetTek Analyzer Platform online help. Select **Start > Help > Settings > Power Management**.

Transporting Lithium-Ion Batteries

Regulations regarding transportation of lithium-ion batteries on passenger aircraft may subject this product to special handling restrictions. Consult your air carrier for applicability and determination of any special lithium-ion battery transportation requirements.

The NetTek Analyzer Platform lithium-ion battery pack contains less than 8 grams of lithium, with individual cells each containing less than 1.5 grams of lithium, as measured by International Civil Aviation Organization (ICAO) standards.

Connecting External Power Supplies

To recharge NetTek Analyzer Platform batteries, or power the NetTek Analyzer Platform from AC mains or DC vehicle voltage, connect the Desktop Power Supply or the In-Vehicle Adapter to the NetTek Analyzer Platform as shown in Figure 1-8. The Desktop Power Supply operates from 110 to 240 VAC mains.

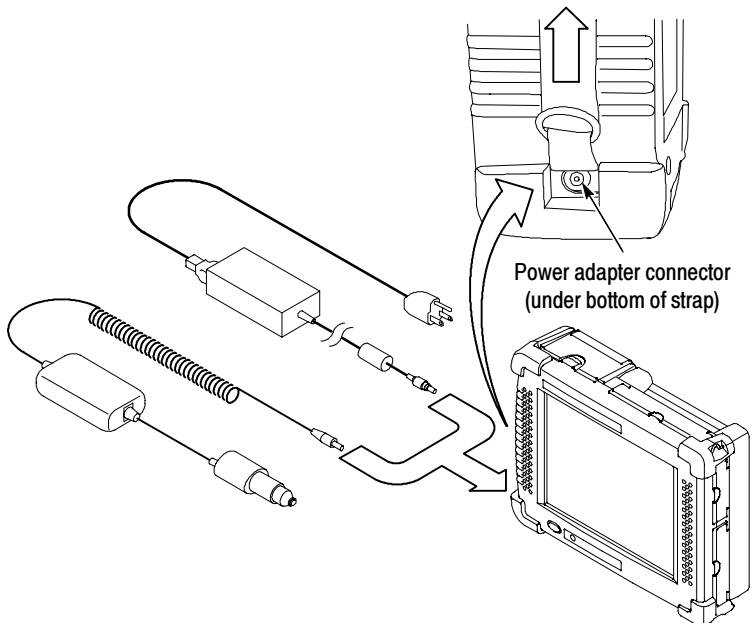

Figure 1-8: External power supplies

Setting Up the Tilt Stand

For floor or desktop use, attach the tilt stand to the NetTek Analyzer Platform and fold into place. See Figure 1-9.

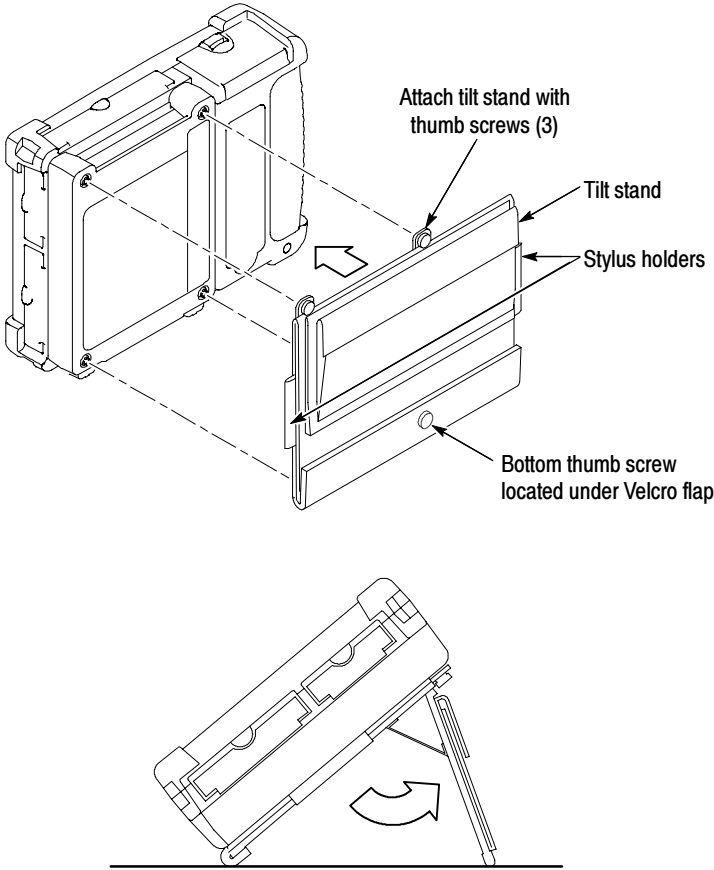

Figure 1-9: NetTek Analyzer Platform tilt stand

To install the tilt stand when two or more instrument modules are attached, use the provided storage pack spacers as shown in Figure 1-10.

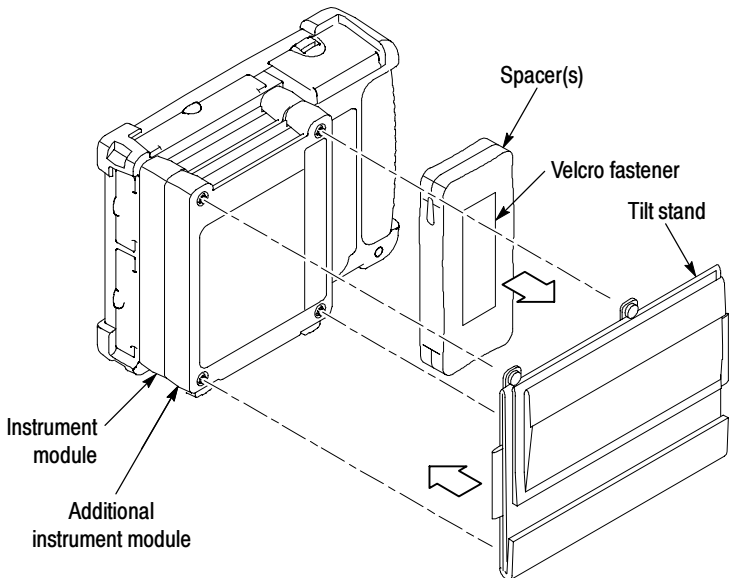

Figure 1-10: Installing the tilt stand on multiple instrument modules

Installing the Shoulder Strap and Strand Hook

Use the shoulder strap to carry the YBT250 to the job site. Install the strap on the YBT250 as shown in Figure 1-11. You can also install the strap on the softcase.

Use the Strand hook to hang the YBT250 from a wire strand, ladder, or other support. Install the strand hook as shown in Figure 1-11.



CAUTION. *The YBT250 Field Transmitter & Interference Tester can weigh in excess of 12 kg (25 lbs), depending on the number of batteries and instrument modules installed. Use caution when hanging the YBT250 from any support.*

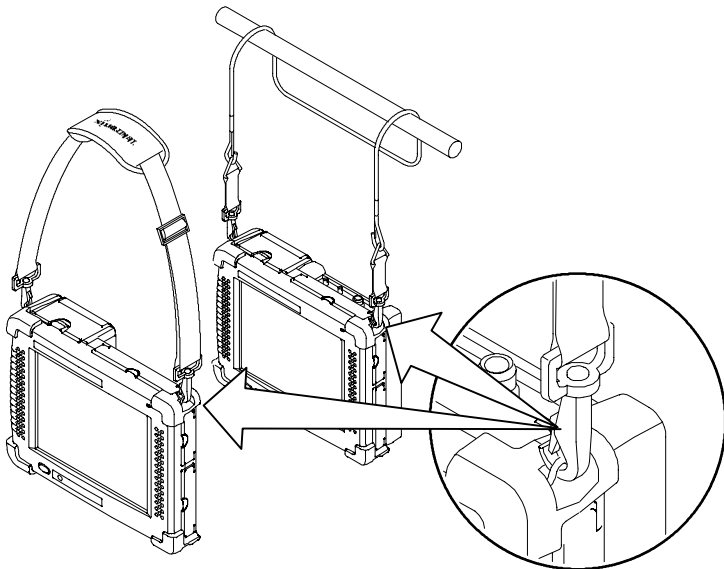

Figure 1-11: YBT250 shoulder strap and strand hook

Powering On the Instrument

To power on the YBT250 Field Transmitter & Interference Tester, press the large blue oval front-panel switch in the lower-left corner. The green status indicator to the right of the switch will light and the system begins its power-on process. The touch-screen display and human interface are described in the *Operating Basics* section.

How the Software Loads

When you press the power switch on the front panel, the NetTek Analyzer Platform powers on and runs its startup diagnostics (if enabled). Once the NetTek Analyzer Platform has completed its power-on sequence, the YBT250 software begins to load.

If there is enough flash memory available, the software loads into flash memory. If there is not enough flash memory available, then the YBT250 software loads into volatile memory (this happens only with user-installed modules; if your YBT250 was purchased already installed on a NetTek Analyzer Platform the software was loaded into flash memory at the factory).

If the software is loaded into flash memory, the time required for the YBT250 to startup each time the instrument is powered on is much shorter. If the software is not loaded in flash memory, the software must be loaded into the NetTek Analyzer Platform each time the instrument is powered on, resulting in a longer start up time. Note that the software load process is automatic, there are no user decisions required or settings available that affect the software load process.

Calibrating the Touch-Screen Display

For the touch-screen display to respond correctly to your taps, you must set the stylus centering and double-tap speed.

Setting the stylus sensitivity

1. Select **Start > Settings > Control Panel**.
2. Open (double-tap) the Stylus icon.
3. In the **Double-Tap** tab, double-tap the checkerboard grid at a comfortable speed with your stylus or finger. This sets the tap rate.
4. Double-tap the clipboard to verify your settings.

Setting the stylus centering

1. Select **Start > Settings > Control Panel**.
2. Open the Stylus icon.
3. In the **Calibration** tab, select **Recalibrate**.
4. Follow the on-screen instructions to set the location and amount of pressure needed for the touch-screen to respond to your taps. Apply pressure to the touch-screen for approximately 5 seconds at each position, until the target moves.
5. Select **OK** to close the dialog box and save your settings.

Powering Off the Instrument

The YBT250 Field Transmitter & Interference Tester has separate, but related, standby and power off functions.

Suspend Mode

The Suspend mode places the YBT250 in a suspended (standby or sleep) state. This is the typical power down mode that allows the YBT250 software to remain in volatile memory. If the YBT250 remains in Suspend mode for an extended time (approximately two hours), it automatically enters Shutdown mode.

To suspend analyzer operation, choose one of the following methods:

- Press the front-panel power switch.
- Select **Start > Shutdown**. In the Shut Down dialog box, select **Suspend**.

To cancel Suspend mode and wake up the YBT250, press the front-panel power switch. The YBT250 will return to the state that existed before suspend mode was invoked.

Shutdown

To completely power down the YBT250, do the following:

1. Select **Start > Shutdown**.
2. In the Shut Down dialog box, select **Shutdown**.

A shutdown clears volatile memory, including the YBT250 software if it is loaded in volatile memory, user setups, and measurement data not saved to nonvolatile memory. For information on how to save these items to nonvolatile memory, refer to the online help. Select **Start > Help**. In the Help window select **Tektronix Basics**; then select **Store Data in Nonvolatile Memory**.

If the YBT250 software was loaded in volatile memory, the next time you press the front-panel power switch, the YBT250 will cycle through the complete power-on process taking about 2 to 3 1/2 minutes to completely power on. If the YBT250 software is loaded in non-volatile memory, it will take less time to power on.

Restart (Software Reset)

If the YBT250 stops responding, try performing a restart to clear the problem.

To restart the YBT250, do the following:

1. Select **Start > Shutdown**.
2. In the Shut Down dialog box, select **Restart**.

The display blanks for approximately five seconds. The YBT250 software will reload and start. Restarting does not empty volatile memory.

If this procedure doesn't work, use a pen or paperclip to press the recessed front-panel RESET button. Resetting *will* empty volatile memory.

Front-Panel Power Switch

Depending on the current state of the YBT250, pressing the front-panel power switch performs one of the following functions:

- If the YBT250 is shutdown: powers on the instrument.
- If the YBT250 is operating: initiates Suspend mode.
- If the YBT250 is in Suspend mode: cancels Suspend mode and activates the YBT250.
- If the analyzer is in PowerSaver mode (touch-screen display off): activates the display.

Preventing Personal Injury from the Effects of Lightning



WARNING. *To prevent personal injury from the effects of lightning, exercise the following precautions when using this product.*

Before connecting this product to any source

- Check your local weather forecast for the possibility of thunderstorms or lightning.
- If weather conditions could allow thunderstorms or lightning to develop, be sure to visually check the sky and weather conditions in your area frequently.
- If you can hear thunder or if you see lightning, do not connect this product to any source which may be exposed to the effects of lightning.
- Use your own good judgement and common sense. You must protect yourself from the effects of lightning.

- You must assume that hazardous voltages will be present on exposed surfaces of this product if it is connected to a source exposed to lightning. The insulation of this product will not protect you from these hazardous voltages.

Do not connect this product to any source which might be subject to the effects of lightning

If thunderstorms or lightning are in your vicinity:

- When weather conditions that could lead to lightning activity exist in your area, *you could be at risk of a lightning strike* before the cloud is close enough for you to hear thunder or see lightning.
- When lightning strikes a structure or facility, current travels through the rebar, concrete, pipes, cables, vent stacks, and electrical system.
- Lightning can induce electric and magnetic fields into structures and portions of wiring. The length of a conductor affected by the magnetic field of a lightning strike may exceed two miles.

Be alert and aware of the effects of lightning

- When lightning strikes a conductor, which in turn introduces the current into an area some distance from the ground strike point, *equipment can be damaged and personnel injured* if they become an indirect path in the completion of the ground circuit.
- Conductors such as the braided shields of cables or unshielded wires will have significant transient currents flowing in them in regions exposed to the electric field effect of lightning.
- Induced voltages may cause breakdown of insulation in wiring at connectors and in electrical components or breakdown of air.



Operating Basics

Operating Basics

This section explains the essential things you need to know to operate the YBT250 Field Transmitter & Interference Tester.

Overview

The YBT250 is a member of the Tektronix NetTek Series of modular instruments that are based on the NetTek Analyzer Platform. A NetTek Series instrument consists of a hardware module, application software, and the NetTek Analyzer Platform. A NetTek Series instrument, such as the YBT250 Field Transmitter & Interference Tester, can be purchased with or without a NetTek Analyzer Platform. Because a NetTek Analyzer Platform can support four instrument modules, it is a highly flexible instrument that can be reconfigured to meet your changing needs.

The NetTek Analyzer Platform is a specialized Windows CE-based computer. The NetTek Analyzer Platform provides the power source and display for NetTek Series instruments. Each NetTek Series instrument provides the circuitry and the software necessary for signal measurement and analysis.

The NetTek Analyzer Platform comes with a touchscreen and stylus. Use the stylus as you would a mouse on your desktop computer. You can select an object by tapping it, move it by dragging it or activate (“open”) it by double-tapping it with your finger or a stylus.



CAUTION. *Only use soft objects, such as plastic or your finger, to tap the touch-screen display. Do not use metal or other abrasive materials, as they will damage the display surface.*

Identifying Front-Panel Controls and Indicators

The front-panel controls power the YBT250 Field Transmitter & Interference Tester on and off, reset the instrument, and indicate status. See Figure 2-1.

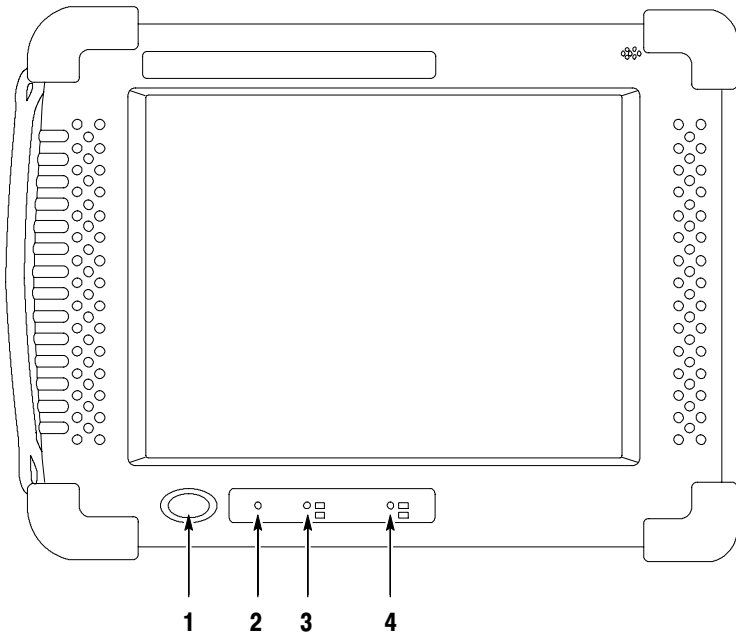

Figure 2- 1: Front-panel controls and indicators

1. **Power/Suspend Switch.** Push on; push off. See pages 1-17 and 2-21 for additional information.
2. **Reset Switch.** Push to perform a hardware reset if a lock-up occurs. Programs and data loaded into volatile memory since startup will be lost.
3. **Status Indicator.** Green indicates power on. Amber indicates display off.
4. **Batteries Indicator.** Green indicates the instrument is connected to an external power source and charging an installed battery. Red indicates low battery.

YBT250 Inputs

Figure 2-2 identifies the YBT250 Field Transmitter & Interference Tester inputs. For identification of the NetTek Analyzer Platform inputs, outputs and storage devices, please refer to the appropriate user documentation.

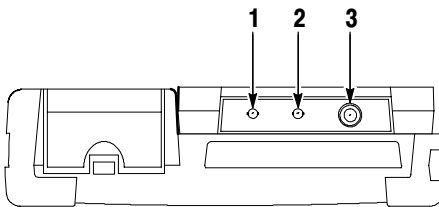

Figure 2-2: YBT250 inputs, outputs, and storage devices.

1. **Timing Input.** Connect to an external timing reference (such as an even second clock).
2. **Frequency Reference Input.** Connect to external frequency reference (for example, 10 MHz Reference).
3. **RF Input.** Connect to signal source.



CAUTION. To prevent damage to the YBT250, continuous input signals should not exceed 1 Watt. If a signal between 1 Watt and 50 Watts is connected to the RF INPUT, the input protection circuitry displays a warning and halts operation until the input overload is corrected. Input signals over 50 Watts will damage the input circuitry.

The input signal-level requirements for measurement accuracy depend on the selected measurement and the installed options. Refer to the specifications in Appendix A for the appropriate input signal levels for specific combinations of measurements and installed options.

Getting Help

To open the Help window and obtain general information on YBT250 topics, select **Start > Help** and select YBT250.

There are three ways to display Help when you are running the YBT250 software:

- First, you can tap the  icon in the upper-right corner of the YBT250 display. This displays the top level of the YBT250 help.
- Second, you can tap underlined text on the screen. This displays the Help topic for the item selected.
- Third, you can display Help from some dialog boxes by tapping the Help button in the bottom-right corner of the dialog box.

The Help Window

Table 2-1 explains how to use the Help window buttons.

Table 2-1: Help window buttons









| Tap this button | To |
|--|---|
|  All Topics | Display the main table of contents. |
|  Back | Return to the previous help screen. |
|  Contents | Display the current program or local table of contents. |
|  | Display full-screen help text. |
|  | Display the help text in its own window. Drag the Help window title bar to move the window. |
|  | Minimize the Help window. To restore the window, tap the Help button in the taskbar. |

Table 2-1: Help window buttons (Cont.)

| Tap this button | To |
|---|--|
|  | Close the Help window and quit help. |
|  | Display information farther up the window. |
|  | Display information farther down the window. |

Navigating the Desktop

The NetTek Analyzer Platform desktop is your primary workspace. Use the desktop to configure hardware and software, adjust settings, establish communications, and access built-in applications.

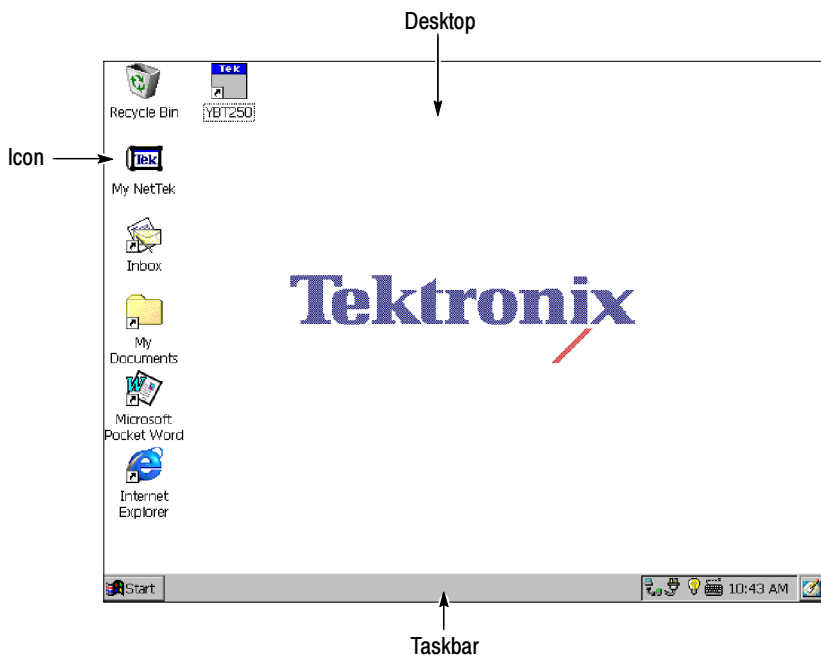

Icons

Double-tap desktop icons to open folders or to start programs.

Taskbar

The Taskbar contains the Start menu, buttons to identify the programs you are running, a status area, and a desktop icon.

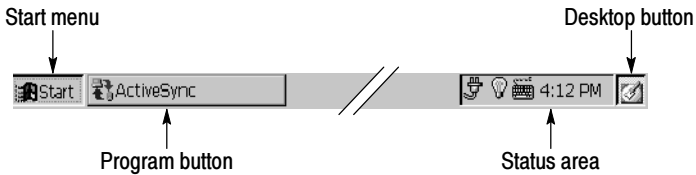

Start Menu. Use the Start menu to load and run other instrument modules and other programs, access settings, open documents, and obtain help. Select (tap) **Start** to open the menu; then select the entry you want.









Program Buttons. To hide a program that is running, tap its taskbar button. To restore the program, tap the button again.

Status Area. Icons and buttons appearing in this area indicate status, activate features, or open settings windows. Double-tap the icons for further information.

Table 2-2 explains the function of some common status icons. For a complete list and explanation of all status area icons, refer to the NetTek Analyzer Platform online help. Select **Start > Help**. In the Help window select **Windows CE Basics**; then select **Understanding Taskbar Icons**.

Table 2-2: Status area icons

| Tap this icon | To | Details |
|---|---|--|
|  | Double-tap to open the Power Management utility. | The analyzer is operating on external AC power. |
|  | Double-tap to open the Power Management utility. | The analyzer is charging batteries. |
|  | Double-tap to open the Power Management utility. | The analyzer is operating on battery power. Also indicates charge level. |
|  | Double-tap to open the Backlight utility. | Adjust the backlight brightness. |
|  | Single-tap to open the Input Panel soft keyboard. | Single-tap to close the keyboard. |
|  | Double-tap to open the Date/Time utility. | Set the date and time. |
|  | Single-tap to minimize all windows and display the desktop. | Tap again to restore all windows. |

Starting the YBT250 Software

If you purchased your YBT250 installed on NetTek Analyzer Platform, it comes from the factory set to automatically start the YBT250 software when you power on the NetTek Analyzer Platform.

If you added your YBT250 module to a NetTek Analyzer Platform you already own, see page 2-9 for instructions on how to start the YBT250 software or set the software to load at startup.

To start the YBT250 software:

- Double-tap the YBT250 icon on the desktop or select **Start > Programs > NetTek > YBT250**

When the YBT250 software starts the first time, it displays the Spectrum display. See Figure 2-3.

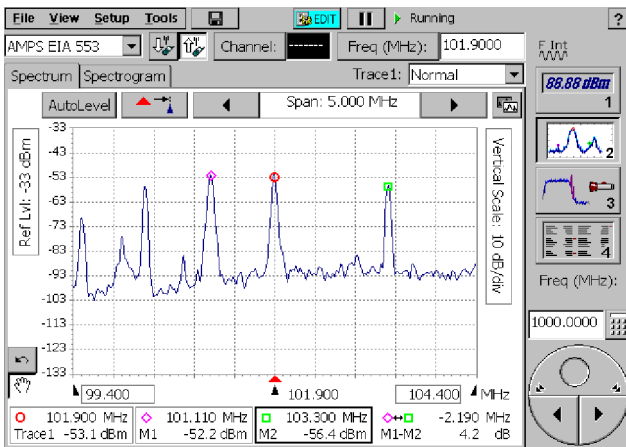

Figure 2-3: The Spectrum display

Setting the YBT250 Software to Load at Startup

If you purchased your YBT250 as a module to use on an existing NetTek Analyzer Platform, you can set the YBT250 to load at startup.

To set the YBT250 as the startup application:

1. Select **Start > Programs > Tektronix Utilities > System Configuration**.
2. On the Software tab, select the StartUp checkbox for the YBT250. See Figure 2-4.
3. Close the System Configuration window.

The next time the NetTek Analyzer Platform is powered on, the YBT250 software starts up automatically.

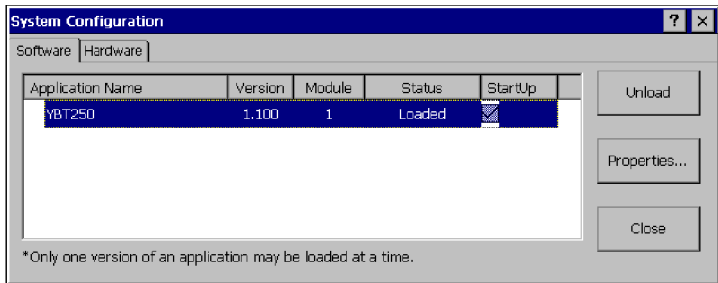

Figure 2-4: Setting the StartUp Application

Elements of the Display

Figure 2-5 shows an example YBT250 Field Transmitter & Interference Tester display.

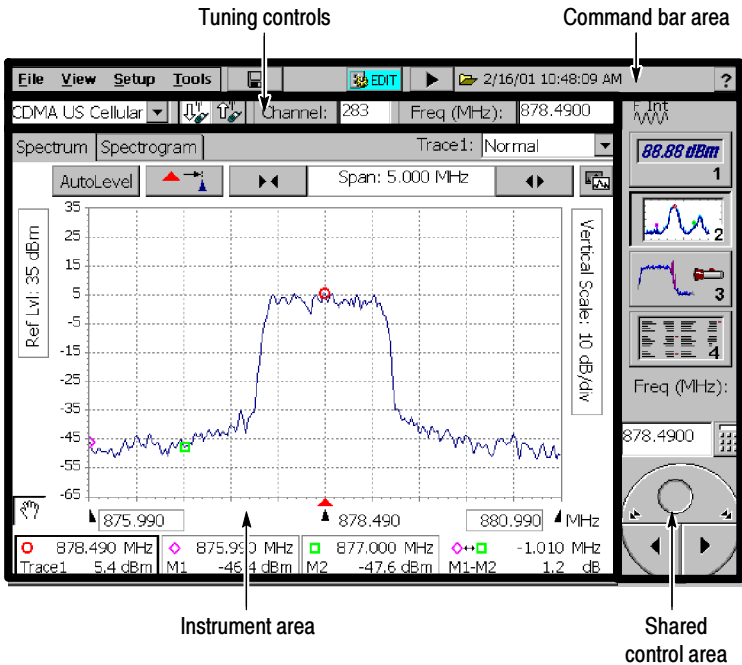

Figure 2-5: YBT250 display elements

The YBT250 display is made up of four areas:

- **Command Bar Area:** This area contains the menu bar and some instrument control buttons. This area is always visible.
- **Tuning Controls Area:** This area contains the controls used to specify the signal standard and measurement frequency. This area is always visible.

- **Shared Control Area:** This is where the instrument function buttons appear and the input box appears. This area is always visible.
- **Instrument Area:** This is where the waveforms are displayed and measurement results appear. The appearance of this area changes depending on the instrument function.

Shared Control Area

Table 2-3 describes the Shared Control Area elements.

Table 2-3: Shared control area buttons and icons







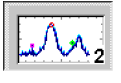
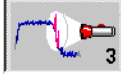

| Button | Function |
|---|--|
|  | Displays Measure window. (only if RF Measurement or Demodulation Option is installed) |
|  | Displays Spectrum window. |
|  | Displays Interference window (only if Interference Option (IN1) or W-CDMA Scrambling Code Analyzer Option (WS1) are installed). |
|  | Displays measurement results in the Sequencer window. This window sequences through the measurements selected in the Selected Measurements dialog box. |
|  | The Knob is used to change the value of the assigned control. |
|  | This area shows the control assigned to the knob and the value of that control. |
|  | The Keypad button enables you to enter numbers using an on-screen numeric keypad. |

Table 2-3: Shared control area buttons and icons (Cont.)

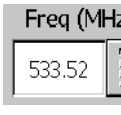
| Button | Function |
|---|--|
|   | These icons show whether the internal frequency reference is in use or an external reference is being used. |
|   | These icons indicate an external attenuator or amplifier is in use. If neither is specified, the icon does not appear. |

Command Bar Area

Table 2-4 describes the elements of the Command Bar Area of the display.

Table 2-4: Command bar area buttons and icons







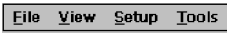

| Button/Icon | Function |
|---|---|
|  | These are the application menus. |
|  | Pressing this button enables you to save measurement results to a file. |
|  | Pressing this button displays the Setup window, which enables you to edit the YBT250 setup. |
|  | Pressing this button pauses measurements (freezes measurements). |
|  | Pressing this button restarts measurements. |
|  | The Running indicator shows that the YBT250 is running. |
|  | The Folder icon is shown when displaying recalled data. |
|  | The Stopped icon is shown when the measurements are paused. |

Table 2-4: Command bar area buttons and icons (Cont.)

| Button/Icon | Function |
|-------------|--|
| | The Timestamp Readout appears when measurements are not running. |
| | Selecting this button displays the YBT250 Online Help. |

Tuning Control Area

Table 2-5 describes the elements of the Tuning Control Area of the display.

Table 2-5: Tuning control area buttons and icons

| Button | Function |
|--------|--|
| | This drop-down list selects the signal standard and channel table. |
| | This button changes the <i>Freq (MHz)</i> setting to the forward link (downlink) frequency for the selected channel, or, in the case of W-CDMA, selects the corresponding forward channel. |
| | This button changes the <i>Freq (MHz)</i> setting to the reverse link (uplink) frequency for the selected channel, or, in the case of W-CDMA, selects the corresponding reverse channel. |
| | This button is used to set the Channel number. The frequency will be set to the appropriate value for the selected channel. Tap the button to use the numeric keypad; tap the box to use the knob. |
| | This button is used to set the Measurement Frequency. Tap the button to use the numeric keypad; tap the box to use the knob. |

Instrument Area

Icons and buttons in the Instrument Area of the display change depending on the selected function:

- For descriptions of Spectrum display buttons and icons, see page 3-2.
- For descriptions of Interference display buttons and icons, see page 3-36.
- For descriptions of Measure display buttons and icons, see page 3-52.

Using the Touch Screen

To select items on the display, just touch them. For example, to display a signal spectrum, simply touch the Spectrum button at the middle right of the display (labeled with a 2).

Using the Knob

To assign the knob to a control, tap the control to be changed. Change the value by:

- tapping the left/right arrows on the bottom half of the control knob make small changes
- tapping to the left or right of the small circle (on the top half) to make larger changes
- placing a finger inside the “circle” and dragging it until the control is set to the desired value

Using the Numeric Keypad

To change a value using the numeric keypad:

1. Tap the control whose value is to be changed (to assign the value to the numeric keypad).
2. Tap the numeric keypad button above the control knob.
3. Type the new value, including units when present.
4. Tap **OK**, when present, to accept the new value.

YBT250 Menus

The YBT250 menu bar has four menus. These menus are File, View, Setup, and Tools. Some menu commands have keyboard shortcuts for use when an optional keyboard is attached to the NetTek Analyzer Platform, but not all menu commands have keyboard shortcuts.

There are three menu commands in the File menu that change depending on the displayed window. The commands are Save Trace/Results, Save Trace/Results As, and Export Trace/Results. Save Trace, Save Trace As and Export Trace commands appear when the Spectrum and Interference windows are displayed (that is, when a signal spectrum is displayed). Save Results, Save Results As and Export Results commands appear when the Measure window is displayed (that is, when measurements are displayed). See Tables 2-6 and 2-7.

Table 2-6: The File menu (Measure window)

| Menu item | Control key | Description |
|----------------------------|--------------------|---|
| <u>O</u> pen | Ctrl + O | Displays Open Results dialog. |
| <u>S</u> ave Results | Ctrl + S | Save measurement results to a file. The file is automatically named and stored in \BuiltInDisk\YBT250\App-Data\Results. |
| Save Results <u>A</u> s | --- | Save measurement results to a file; displays Save dialog so you can name the file and specify where it is saved. |
| Compare Saved | --- | Display two saved results for visual comparison. (Disabled) |
| <u>E</u> xport Results As | --- | Save measurement results in a file format that can be used by word processing or spreadsheet applications. |
| Export <u>S</u> creen As | --- | Store an image of the display that can be used by word processing or image editing applications. |
| <u>P</u> rint | Ctrl + P | Prints the displayed window's data. |
| <u>R</u> esults Properties | --- | Displays a dialog that shows information saved with a results file. |
| <u>E</u> xit | --- | Quits the YBT250 program. |

Table 2-7: The File menu (Spectrum/Interference windows)

| Menu item | Control key | Description |
|----------------------------|--------------------|---|
| <u>O</u> pen | Ctrl + O | Displays Open Results dialog |
| <u>S</u> ave Trace | Ctrl + S | Saves a Trace to a file. The file is automatically named and stored in \BuiltInDisk\YBT250\AppData\Results. |
| Save Trace <u>A</u> s | --- | Store Trace in a file; displays Save dialog to enable you to name the file and specify where it is saved. |
| Compare Saved | --- | Display two saved results for visual comparison. |
| <u>E</u> xport Trace As | --- | Store Trace in a file format that can be used by word processing or spreadsheet applications. |
| Export <u>S</u> creen As | --- | Store an image of the display that can be used by word processing or image editing applications. |
| <u>P</u> rint | Ctrl + P | Prints the displayed window's data. |
| <u>R</u> esults Properties | --- | Displays a dialog that shows information saved with a results file. |
| <u>E</u> xit | --- | Quits the YBT250 program. |

Table 2-8 describes the elements of the View menu.

Table 2-8: The View menu

| Menu item | Control key | Description |
|----------------------------|--------------------|---|
| <u>T</u> race 2 | --- | Displays/Hides second trace. |
| <u>R</u> otate Trace Order | --- | Changes the order of traces in the graph (front versus back). |
| <u>D</u> efine Trace 2 | --- | Displays the Trace 2 & Mask tab of the Setup window, enabling you to specify the source of Trace 2. |
| <u>M</u> ask | --- | Enables Mask Testing. |
| Define <u>M</u> ask | --- | Displays the Trace 2 & Mask tab of the Setup window, enabling you to specify the mask file to use for mask testing and any action to perform on mask failure. |
| <u>M</u> arkers | Ctrl + M | Displays/Hides marker controls and readouts. |
| Band Edge <u>C</u> ursor | --- | Displays/Hides band edge cursors. |
| M1 Trace 1, M2 Trace 2 | | Places marker M1 on Trace 1, and places marker M2 on Trace 2 (only with Trace 2 enabled). |
| Both on front trace | | Places both markers on the front trace (only with Trace 2 enabled). |
| Both on Trace 1 | | Places both markers on Trace 1 (only with Trace 2 enabled). |
| Both on Trace 2 | | Places both markers on Trace 2 (only with Trace 2 enabled). |

Table 2-9 describes the elements of the Setup menu.

Table 2-9: The Setup menu

| Menu item | Control key | Description |
|-------------------|--------------------|---|
| <u>E</u> dit.. | Ctrl + T | Displays the Setup window. |
| <u>O</u> pen... | --- | Displays the Open Setup dialog. |
| <u>S</u> ave... | --- | Saves current setup to a file. |
| <u>P</u> reset | Ctrl + A | Recalls defaults except for Signal Standard, Channel and Frequency; sets the span to cover the selected Signal Standards frequency range. |
| <Saved Setup 1-N> | | Name of most recently used setup files or files specified in Tools>Options>Settings Menu. Up to 10 files can be displayed. |

Table 2-10 describes the elements of the Tools menu.

Table 2-10: The Tools menu

| Menu item | Control key | Description |
|---------------------------------|--------------------|---|
| <u>O</u> ptions... | --- | Displays the Options window. |
| <u>K</u> eyboard | Ctrl + K | Displays/Hides the soft keyboard. |
| <u>T</u> ouchscreen Calibration | --- | Displays the Windows CE Stylus utility. |
| Mask Maker | --- | Displays the Mask Maker utility. |
| <u>F</u> requency Correction | --- | Displays the utility for improving frequency measurement accuracy. |
| Factory Reset | --- | Resets all YBT250 settings to original factory values; overwrites existing settings. |
| <u>U</u> ppgrade Software | --- | Displays the utility for enabling software options or installing a new version of the YBT250 application. |

Table 2-10: The Tools menu (Cont.)

| Menu item | Control key | Description |
|-----------------------|-------------|--|
| Technical Support | --- | Displays technical support contact information. |
| <u>S</u> oftware Info | --- | Displays the SW Properties window which lists, among other things, the installed options, Options key, and software version. |
| <u>H</u> ardware Info | --- | Displays the HW Properties window which lists, among other things, serial number, hardware versions, and Global ID. |

Entering Text

Use the Input Panel soft keyboard, see Figure 2-6, to type characters into text boxes or address fields without using an external keyboard.

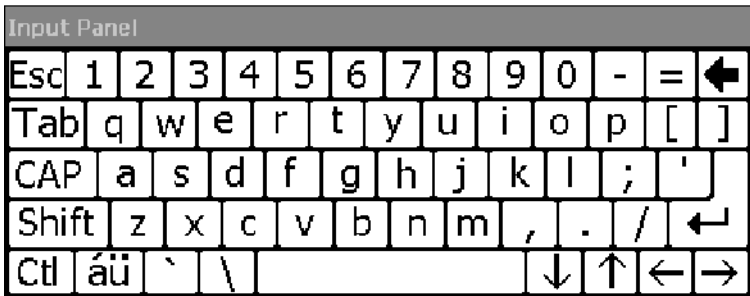





Figure 2-6: The Soft Keyboard

To open the soft keyboard:

1. Tap the  icon in the toolbar status area.
2. Tap the Input Panel keys to enter text.
3. Tap  (RETURN) to wrap text or execute a command.
4. Tap the  icon again to close the keyboard.

To set soft keyboard properties, select **Start > Settings > Control Panel**. Open the Input Panel icon, and then select **Options**.

Special Characters

The soft keyboard includes characters not visible on the startup keyboard.

CAP Key. Tap the **CAP** key to create all capital letters and common characters.

Shift Key. Tap the **Shift** key to create one capital letter or other common character.

 **Key.** Tap this key to create special characters.

Powering Off the YBT250

The YBT250 has separate, interrelated standby and power off functions similar to a laptop PC.

Suspend Mode

To suspend YBT250 operation, choose one of the following methods:

- Press the front-panel power switch.
- Select **Start > Shutdown**. In the Shut Down dialog box, select **Suspend**.

Suspend mode places the YBT250 in a suspended (standby or sleep) state. This is the typical power off mode that allows the YBT250 software to remain in volatile memory. If the YBT250 remains in Suspend mode for an extended time (approximately two hours), it will automatically enter Shutdown mode and the contents of volatile memory will be lost.

To activate the YBT250 following Suspend, press the front-panel power switch. The YBT250 will return to the software and setup state that existed before the user invoked suspend.

Shutdown

To completely power down the YBT250:

1. Select **Start > Shutdown**.
2. In the Shut Down dialog box, select **Shutdown**.

A shutdown clears volatile memory, including the YBT250 software (if it is not loaded into flash memory) and measurement data not saved to nonvolatile memory. For information on how to save these items to nonvolatile memory, refer to the NetTek Analyzer Platform online help. Select **Start > Help**. In the Help window select **Tektronix Basics**; then select **Store Data in Nonvolatile Memory**.

The next time you press the front-panel power switch following a shutdown, the YBT250 does the complete power up process taking about 2 to 3 minutes for the YBT250 to become functional.

Restart (Software Reset)

To restart the YBT250, do the following:

1. Select **Start > Shutdown**.
2. In the Shut Down dialog box, select **Restart**.

The display blanks for approximately five seconds, then the YBT250 software reloads. A Restart does not empty volatile memory.

Connecting a Signal

This section explains how to connect an RF signal, a timing reference and a frequency reference to the YBT250 Field Transmitter & Interference Tester.

RF Signal Input Parameters

The YBT250 has a single, RF signal input. The input impedance is 50Ω . The input frequency range is 30 MHz to 2500 MHz. The maximum continuous input power is 1 W. Figure 2-7 shows the location of the RF Input connector.

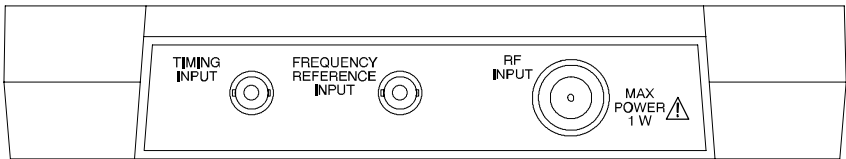

Figure 2-7: Input connectors

Depending on whether you want to display a spectrum or take measurements, you may need to attach an attenuator or an external amplifier to the RF signal before connecting it to the YBT250. See page 2-24 for instructions on using an attenuator or an external amplifier with the YBT250.

The input signal-level requirements for measurement accuracy depend on the selected measurement and the installed options. Refer to the specifications in Appendix A for the appropriate input signal levels for specific combinations of measurements and installed options.

Connecting an RF Signal

Connect a signal from a base station transmitter test port to the YBT250 RF INPUT connector.

If there is no test port, do the following:

1. Disconnect the transmitter cable from the antenna.
2. If the transmitter output signal level is too high (refer to the specifications in Appendix A), connect the transmitter output signal to an attenuator, and then connect the output of the attenuator to the RF Input connector.



CAUTION. To prevent damage to the YBT250, continuous input signals should not exceed 1 Watt. If a signal between 1 Watt and 50 Watts is connected to the input, the input protection circuitry displays a warning and halts operation until the input overload is corrected. Input signals over 50 Watts will damage the input circuitry.

3. If the transmitter output signal level is too low (see the specifications in Appendix A), connect the transmitter output signal to an external amplifier, and then connect the output of the amplifier to the RF Input connector.
4. Set or verify that the YBT250 input settings are properly set. The YBT250 adjusts its measurement readouts and graphic displays to account for the use of an external attenuator or amplifier.
 - a. Tap the **Edit** button (). This displays the **Setup** window.
 - b. Tap the **Inputs** tab. See Figure 2-8.
 - c. If no external attenuation or amplification is used, verify that the **No external attenuation or amplification** setting is selected.

- d. If an external attenuator is used, select **External attenuator connected**. Tap the numeric keypad and enter the attenuator loss value. For example, if you are using a 20 dB attenuator, tap 20 on the numeric keypad, and then tap **OK**.
- e. If an external amplifier is used, select **External amplifier connected**. Tap the numeric keypad and enter the value of the amplifier gain. For example, if the amplifier has a 20 dB gain, tap 20 on the numeric keypad, and then tap **OK**.
- f. Once you have finished verifying the settings, tap **OK** at the bottom of the window.

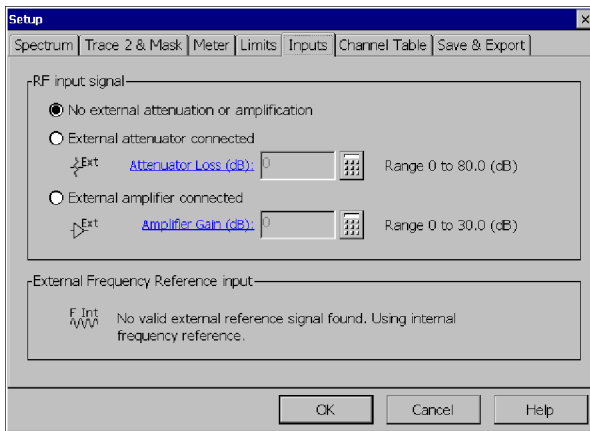

Figure 2-8: Changing input settings

Connecting a Timing Reference (cdmaOne/cdma2000 /1xEV-DO Only)

To properly measure PN Offset and Tau/Pilot Time Alignment Error (requires Option CD1, CD2, or CDE), you must connect an external Even Second Clock to the YBT250. Figure 2-7 on page 2-23 shows the location of the timing reference input connector.

To connect an Even Second Clock to the YBT250, connect the Even Second Clock signal to the **TIMING INPUT** connector. The signal will be automatically detected by the YBT250.

Connecting an External Frequency Reference

To minimize the frequency variation between the YBT250 and the BTS, you can connect an external frequency reference to the YBT250. Table 2-11 shows the acceptable frequencies for an external frequency reference. The external reference must have an accuracy better than ± 1 ppm. The acceptable signal level is -15 dBm to + 15 dBm. Figure 2-7 shows the location of the frequency reference input connector. The input impedance is 50 Ω .

Table 2-11: Accepted external frequency reference signals

| External reference frequency | Transmitter/Frequency reference |
|------------------------------|--|
| 1 to 15 MHz, in 1 MHz steps | |
| 4.8 MHz | For Nortel BTS equipment. |
| 10 MHz | Standard frequency for WWV and other high-accuracy references. |
| 13 MHz | For GSM systems. |
| 15 MHz | For Lucent W-CDMA. |
| 1 MHz, 2 MHz, 5 MHz | Along with 10 MHz, these are standard for Rubidium and other high-accuracy References. |
| 19.6608 MHz | For Motorola, Qualcomm, and newer Nortel. Used for CDMA only. |

Table 2-11: Accepted external frequency reference signals (Cont.)

| External reference frequency | Transmitter/Frequency reference |
|--|---|
| 1.2288 MHz, 2.4576 MHz, 4.9152 MHz, 9.8304 MHz | These are also multiples of the CDMA chip rate. |
| 2.048 MHz | For Ericsson BTS equipment with E1 reference source |

To connect an external frequency reference to the YBT250:

1. Connect the frequency reference signal to the **FREQUENCY REFERENCE INPUT** connector. The signal will be automatically detected by the YBT250.

Whenever a valid external frequency reference is present, it will be used as the frequency (time base) reference.

You can verify that the YBT250 recognizes the frequency reference signal by displaying the Setup window.

2. Tap the **EDIT** button. This displays the Setup window.
3. Tap the **Inputs** tab. See Figure 2-9.

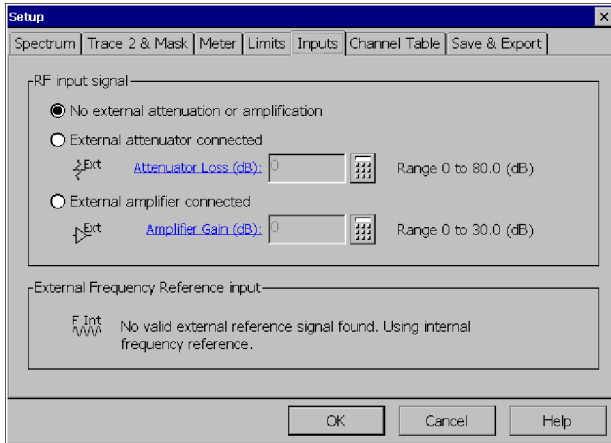

Figure 2-9: Inputs tab

When the YBT250 recognizes the frequency reference, the **External Frequency Reference Input** box displays an icon with the letters EXT and displays the text:

Frequency locked to external reference signal: XXXX.XXX MHz

where XXX.XXX is the frequency of the reference.

If the YBT250 does not recognize the frequency reference, the **External Frequency Reference Input** box displays an icon with the letters INT and displays the text:

No valid external reference signal found. Using internal frequency reference.

Check the connections and verify that the frequency reference is within the correct frequency range and level.

Improving Frequency Accuracy

If you plan to use your YBT250 at a site where a high-accuracy frequency reference source is not available, you may be able to improve frequency measurement accuracy in some instances by creating your own “custom” correction factors using the frequency correction utility. This utility compares the YBT250 internal frequency reference to an external reference and calculates correction values to align the internal frequency reference with the external reference. You can then choose to use either the newly generated correction values or the original factory-generated values when at a remote site.

You should run the Frequency Correction utility only if you have a known high-quality Reference source available to use. The Reference source frequency accuracy directly affects the accuracy of the frequency correction values. A poorly calibrated Reference source can result in correction values that degrade measurement results. You must also allow the YBT250 to warm up for at least 10 minutes before running the Frequency Correction utility.

To run the frequency correction utility:

1. Connect a frequency reference signal to the **FREQUENCY REFERENCE INPUT**.
2. Select **Tools > Frequency Correction**. This displays the Frequency Correction dialog shown in Figure 2-10.

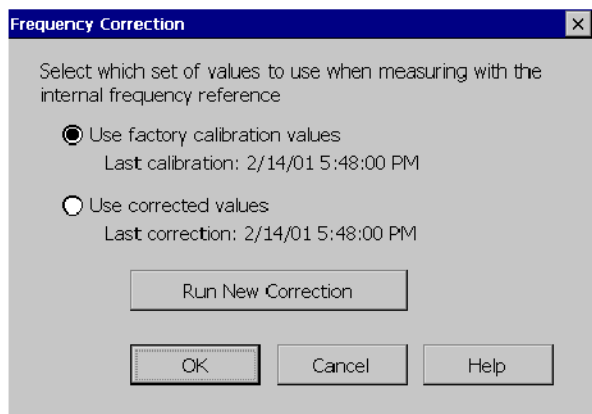

Figure 2- 10: The Frequency Correction dialog

3. To calculate new frequency correction values, tap **Run New Correction**. This displays the dialog shown in Figure 2-11.

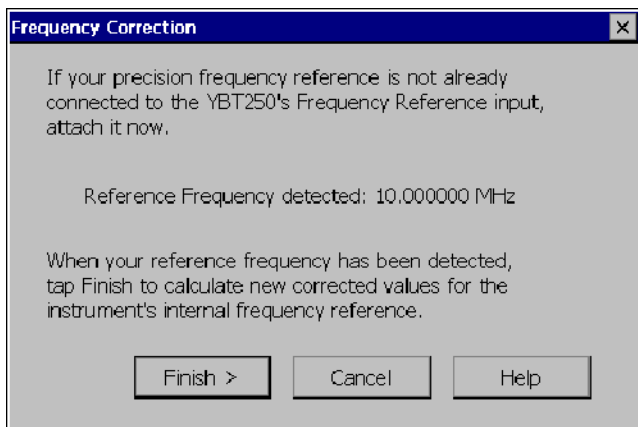

Figure 2- 11: Ready to calculate new correction values

If the reference frequency is detected, the frequency will appear in the dialog box. If the reference frequency is not detected, "--" will be displayed instead of a frequency. If the reference frequency is not displayed within 15 seconds, check the connection to the external frequency reference.

4. If the reference frequency is detected, tap **Finish >** to calculate new frequency correction values.

If the calculation of new frequency correction values is successful, the dialog shown in Figure 2-12 appears.

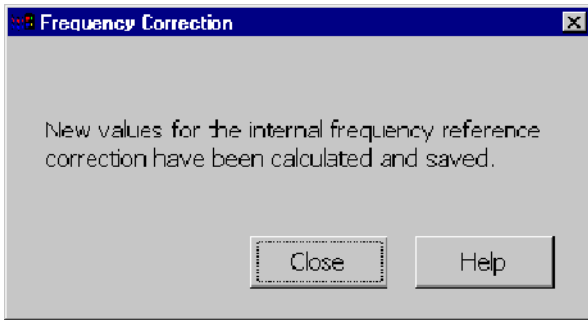

Figure 2-12: New frequency correction values calculated successfully

5. Tap **Close**. This displays the initial frequency correction dialog shown in Figure 2-13.

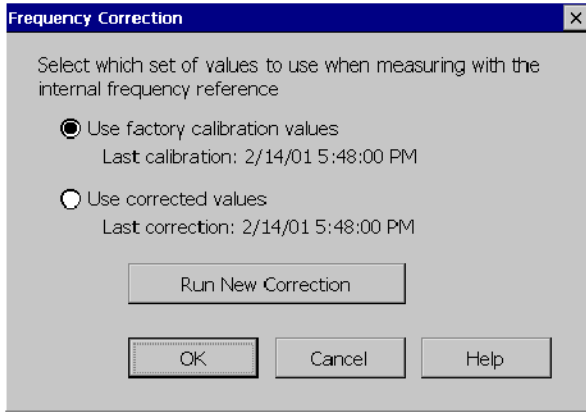

Figure 2-13: The Frequency Correction dialog

6. To use the new frequency correction values, select **Use Corrected Values**, then tap **OK**.



Changing Instrument Settings

Before you can fully utilize the YBT250 you need to set some instrument settings. For example, the YBT250 displays measurements only for enabled signal standards. If the signal standard used in your system is not enabled, you will not be able to take measurements for your system until you enable the Signal Standard.

Enabling Signal Standards

The currently selected signal standard controls the channels available for measurements and which measurements are available. Before you begin using the YBT250, you must ensure that the standard for your system has been enabled. Signal standards are enabled from the Options window.

To enable a signal standard:

1. Select **Tools > Options** to display the Options window, shown in Figure 2-14.

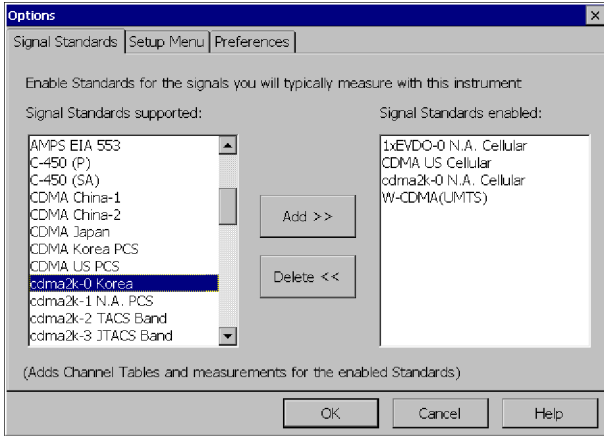

Figure 2-14: The Options window

The standards supported in your YBT250 are shown in the list on the left side of the window.

NOTE. If you need to test a standard that does not appear in the list of supported standards, you can create a custom channel table file for the standard. See page 2-40.

2. To enable a signal standard, tap the name of the standard you wish to enable and then tap **Add>>**.
3. When you have enabled all the standards you will be testing, tap **OK**.

Only enabled standards are selectable from the signal standards list that appears in the tuning controls area of the display. When you take measurements with the YBT250, you can only take measurements on enabled standards. You will probably want to limit the number of standards enabled to just those you test regularly to speed up the act of a selecting standard from the Signal Standard drop down list.

Setting Display Preferences

The YBT250 enables you to change the color scheme used in the display. There are three color schemes, one monochrome scheme, and a color scheme optimized for black and white printouts. Color schemes specified in the YBT250 do not affect standard Windows CE screen items. The YBT250 color schemes affect only measurement graphs and results readouts in the YBT250 display.

To specify the color scheme used by the YBT250:

1. Select **Tools > Options**.
2. Select the **Preferences** tab. This displays the window shown in Figure 2-15.

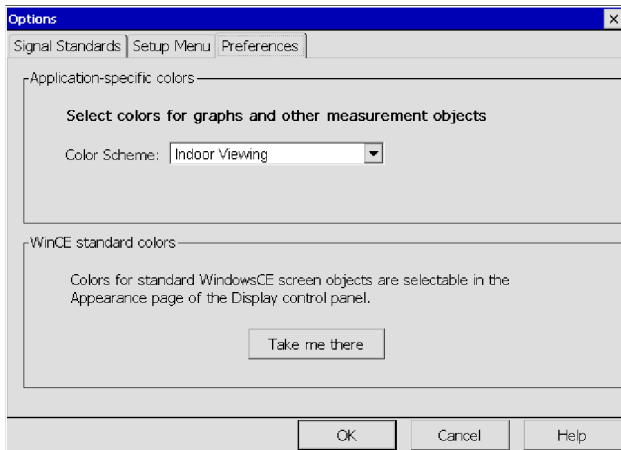

Figure 2-15: Preferences tab showing available color schemes

3. To display a list of the available color schemes, tap the **Color Scheme** list box. Available color schemes are Indoor Viewing, Outdoor Viewing, Dark on white, Monochrome grays, and Black on White for Printer.

4. To select a color scheme, tap the name of the desired color scheme.
 - a. To change the Windows CE display properties, tap **Take Me There**. This displays the Windows CE Display Properties window, where you can set the display background and window color scheme.
5. Tap **OK** to save the change.
6. To view the changed color scheme, quit the YBT250 program and restart it.

Setting Up the Channel Table

Before taking measurements, you must set the measurement frequency. You set the measurement frequency either by entering the appropriate frequency or by selecting a channel. It is quicker to select a channel than to enter a frequency. Selecting a channel to set the measurement frequency can save you valuable time and minimizes entry errors.

A quick way to set a channel number is to use the knob. By tapping the left and right arrows on the knob, you can quickly change the selected channel and thus, the measurement frequency. The channels that are selectable using the knob are set by the Quick Select List. The channels listed in the Quick Select List are specified by the Channel Table.

You set up the Channel Table by enabling channels individually or by using the Channel Wizard. If you want to enable a large number of channels, use the Channel Wizard to save time.

To set up the Channel Table by enabling channels individually:

1. Select the **Edit** button or choose **Setup> Edit**.
2. Select the **Channel Table** tab.

This displays the window shown in Figure 2-16.

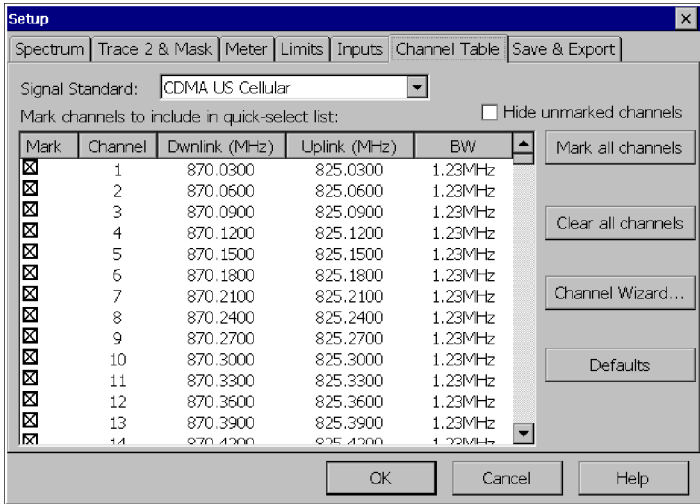

Figure 2-16: The Channel Table

Channels are enabled according to the signal standard. Thus, before you enable channels, you must specify the signal standard.

3. Select the desired signal standard from the **Signal Standard** list.
4. To enable a channel:
 - a. Tap the box in the **Mark** column next to the desired channel. Enabled channels are marked with an X.
 - b. You can mark all channels by tapping the **Mark All Channels** button.

Enabled channels are added to the Quick Select List. The Quick Select List determines which channels can be selected by the knob. For example, suppose only channels 1, 2, 5, and 6 are enabled. If channel 1 is the current channel and you tap the right arrow (on the bottom half) on the knob, the next channel selected will be channel 2. If you tap the knob again, the next channel selected will be 5. Tap the right arrow once more and channel 6 will be selected. If you tap the right

arrow once more, the channel selected will not change, because there are no channels enabled after 6.

5. To disable a selected channel:
 - a. Tap the box in the **Mark** column next to the enabled channel so that the box is empty.
 - b. You can disable or “unmark” all channels by tapping the **Clear All Channels** button.
6. When you have marked all the channels you wish to enable, tap **OK** to save your changes.

To set up the Channel Table using the Channel Wizard:

1. Select the **Edit** button or choose **Setup> Edit**.
2. Select the **Channel Table** tab.

Channels are enabled by signal standard. Thus, before you enable channels, you must specify the signal standard.
3. Select the desired signal standard from the **Signal Standard** list.
4. To enable channels using the Channel Wizard:
 - a. Tap the **Channel Wizard...** button. This displays the window shown in Figure 2-17.

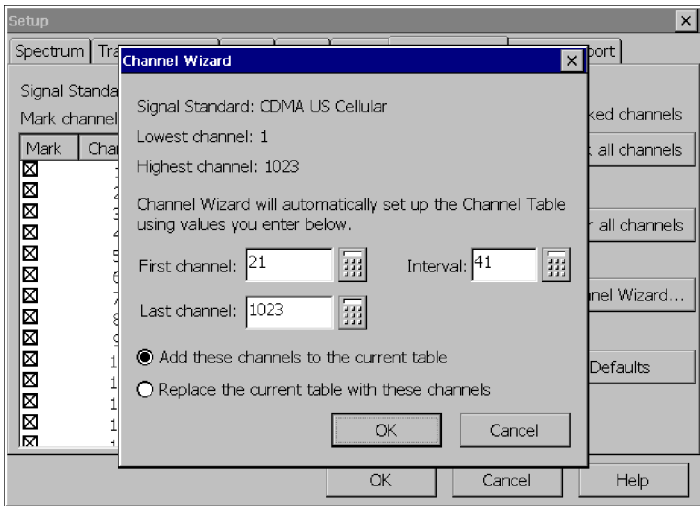

Figure 2-17: The Channel Wizard

The Channel Wizard needs three numbers to determine which channels should be enabled. The first number needed is the first channel that should be enabled. The second number needed is the last channel to be enabled. The third number is the interval between enabled channels.

5. To set the first channel number:
 - a. Tap the numeric keypad button next to the **First Channel** box.
 - b. Tap the appropriate numbers to set the first channel number.
 - c. Tap **OK** when finished.
6. To set the last channel number:
 - a. Tap the numeric keypad button next to the **Last Channel** box.

- b. Tap the appropriate numbers to set the last channel number.
 - c. Tap **OK** when finished.
 7. To set the interval between enabled channels:
 - a. Tap the numeric keypad button next to the **Interval** box. Next, tap the appropriate number for the interval.

For example, to enable every channel, set the interval to 1. To enable every other channel, set the interval to 2. To enable every third channel, set the interval to 3.
 - b. To add the specified channels to the existing channel table, select **Add these channels to the current table**.
 - c. To replace the current channel table with the specified selections, select **Replace the current table with these channels**.
 - d. Tap **OK** when finished.
 8. Tap **OK** to close the Setup window.

Customizing the Channel Table

The Channel Table is a file used by the YBT250 to specify the characteristics of the channels assigned to a signal standard. You can customize the Channel Table to suit the specific needs of your system. For example, if you have set the bandwidth of your channels to be wider than the standard bandwidth, you can specify the wider bandwidth in a customized Channel Table. Because the channel bandwidth is used in some measurements, if your system's channel bandwidth is non-standard and the YBT250 is using the standard Channel Table, a measurement based on the standard channel bandwidth will not be accurate for your system.

The YBT250 looks for a file named `userstandards.txt` in the `\BuiltInDisk` folder when it starts up. If it does not find the file, the YBT250 then looks for the standard channel table file, `signalstandards.txt`, in the `NetTekApps\YBT250` folder. If that file is not found, a dialog box will be displayed informing you that no standards file

was found, so a new channel table will be generated using internal default values.

Creating a Custom Channel Table

To create a custom channel table:

1. Locate the existing **signalstandards.txt** file in either the **\BuiltInDisk\NefTekApps\YBT250** folder or **\NefTekApps\YBT250** folder (only if the application software is loaded into volatile memory instead of flash memory).
2. Copy the **signalstandards.txt** file to the **\BuiltInDisk** folder.
The YBT250 will look only in the **\BuiltInDisk** folder for a custom channel table.
3. Rename **signalstandards.txt** to **userstandards.txt**.
4. Edit the contents of the file to suit your systems settings.

When editing your **userstandards.txt** file, it is safer to copy a row and then edit the copied row to meet your requirements than to modify an existing row.

Table 2-12 lists the elements of the Channel Table file.

Table 2-12: Channel table file contents

| Column heading | Description |
|-------------------------|---|
| Standard Name | <p>The text string used to identify the standard. This name is what appears in the Signal Standard list.</p> <p>Each line in the channel table should describe a single group of channels for a standard. If a standard is made up of multiple groups or blocks of channels then you should make an entry for each group. When multiple groups are required, they should be ordered in channel number sequence and contiguous. To tie the groups together, the Unique Standard ID must be the same for each group.</p> |
| Forward Base Frequency | <p>Forward base frequency for each signal standard. The actual frequency for each channel is calculated.</p> <p>For signal standards that specify a single frequency for each channel (for example, the UTRA/FDD scheme used by W-CDMA (UMTS)), each row in the file will describe a group of forward or a group of reverse channels. The row that describes forward channels should specify zero for the reverse base frequency. The row that describes reverse channels should specify zero for the forward base frequency.</p> |
| Reverse Base Frequency | <p>Reverse base frequency for each signal standard. The actual frequency for each channel is calculated.</p> <p>For signal standards that specify a single frequency for each channel (for example, the UTRA/FDD scheme used by W-CDMA (UMTS)), each row in the file will describe a group of forward or a group of reverse channels. The row that describes forward channels should specify zero for the reverse base frequency. The row that describes reverse channels should specify zero for the forward base frequency.</p> |
| Signal Bandwidth | <p>The signal bandwidth. If the signal to be measured is 100 kHz wide but the channels are spaced 200 kHz apart then this field should contain 100000.</p> |
| Starting Channel Number | <p>The starting channel number for a block of channels.</p> |
| Ending Channel Number | <p>The ending channel number for a block of channels.</p> |

Table 2-12: Channel table file contents (Cont.)

| Column heading | Description |
|--|---|
| Channel Increment Amount | If the channels increment by 1, then a 1 goes in here. If by 2, then a 2 goes in here. If by 5... |
| Channel Spacing | Sets the spacing between channels. For instance, if you have a standard that has signals that are 100 kHz wide but the channels in your system are spaced 200 kHz apart, then this field should contain 200000. |
| Channel Offset | Offset applied to channel number before calculating the channel frequency from the channel number. |
| Unique Standard ID | Must be between 0 and 400. It is used to tie multiple blocks of channels together into a single standard. A block of channels is a single row in the channel table file. |
| Signal Type | 1 = CDMAOne 2 = AMPS 3 = TDMA IS136 4 = GSM/EDGE 5 = W-CDMA (UMTS) 6 = CDMA 2000 10 = CDMA 2000 1xEV-DO 998 = NO_MEAS_ANALOG 999 = NO_MEAS_DIGITAL |
| Forward / Reverse frequency separation | 190000000 for W-CDMA (UMTS) For signal standards that specify a single frequency for each channel (for example, the UTRA/FDD scheme used by W-CDMA (UMTS)), this entry specifies the difference in frequency between a forward channel and its corresponding reverse channel. For signal standards that specify forward and reverse frequencies for each channel (most standards), this entry is left blank. |

Specifying the Signal Type

The Channel Table file contains a field that defines the type of signal for the named signal standard. For example, the standard named GSM 900 is designated as a Signal Type 4. The Signal Type is used by the Signal Identification function to suggest possible sources of interference.

Although the YBT250 will make measurements only on the first seven signal types listed in Table 2-12, you can define a signal standard that is based on other signal types. For example, you could create an FM signal standard of signal type 998 (Analog signal, no measurements available) and define channels within the FM radio band. This would allow you to tune to “channels” within the FM band, although you could not take measurements with the YBT250.

The reason for creating a signal standard is that the Signal Identification function uses the Channel Table to determine possible types of signals, and if you have defined a signal standard, then it will appear as a possible source in the Signal Identification function.

The signal types 998 and 999 are included in the Channel Table to enable you to create a custom signal standard for analog or digital signals that do not match the other signal types (such as an “FM” standard noted previously). Though no measurements would be made on channels of a standard based on either 998 or 999, the standard they are assigned to would be used by the Signal Identification function.

How Channel Frequencies are Calculated

The frequency for a specific channel is calculated with a formula based on the current channel number, the base frequency, the channel spacing and the channel offset:

If (Channel Offset \geq 0)

$$\text{Chan Freq} = (\text{Chan Num} - \text{Channel Offset}) \times \text{Channel Spacing} + \text{Base Frequency}$$

If (Channel Offset < 0)

$$\text{Chan Freq} = \text{Base Frequency} - ((-\text{Channel Offset} - \text{Chan Num}) \times \text{Channel Spacing})$$

Where:

Base Frequency: Either forward or reverse base frequency depending on current user selection, from the Channel Table file (userstandards.txt when present or signalstandards.txt).

Chan Num: The current user selected channel number.

Chan Freq: The frequency associated with the Chan Num.

Channel Spacing: The distance between channels, from the Channel Table file.

Channel Offset: From the Channel Table file.

Changing Settings for Saved Files

The YBT250 enables you to specify default settings for saving files.

- filename prefixes
- name of a technician making a test
- notes to be included in saved results files
- format of exported screens
- the format of saved or exported results files
- location to which files will be saved or exported during Spectrogram and Codogram Auto Save

The headings that follow provide additional information on how to set these defaults.

Where to Set File Options

The **Save & Export** tab is where you specify saved file options.

To display the Save & Export tab:

1. Select **Setup > Edit**.
2. Tap the **Save & Export** tab. See Figure 2-18.

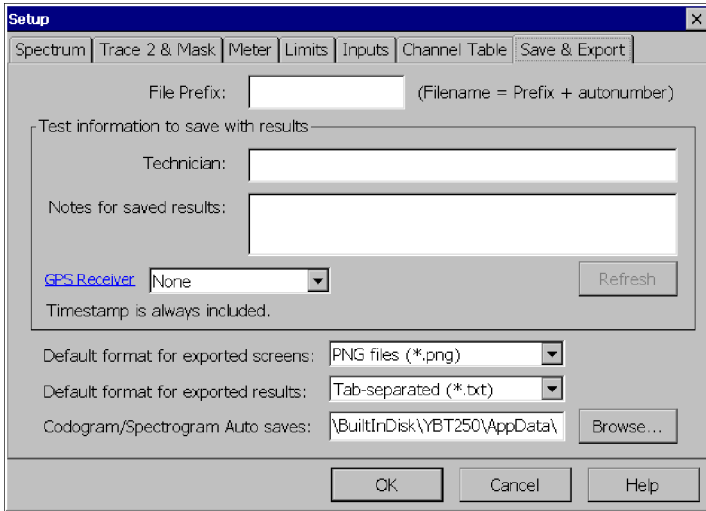

Figure 2- 18: The Save & Export tab

Setting the Filename Prefix

The YBT250 allows you to save a file, such as a results file, with a name you enter each time you save a file or you can allow the YBT250 to automatically name files for you. When files are saved without a specified prefix, the filename is simply a number, for example: 0004.r01.

However, you can specify a prefix for automatically named files so that you can more easily identify saved files. Actual filenames will consist of the prefix you enter attached to a number, which is generated when the file is saved. For example, if you are testing Site 5 you could set the prefix to s5, resulting in a filename of s50004.r01.

NOTE. *The length of a filename is variable, depending on the length of the path (where the file is located). The limit of the path and filename is 256 characters. The shorter the path to the file, the longer the filename can be.*

To specify the filename prefix:

1. Select **Setup > Edit**. This displays the Setup window.
2. Tap the **Save & Export** tab. See Figure 2-18.
3. Tap the box after **File Prefix:**.
4. Enter text (using the soft keyboard or an external keyboard) to use as the prefix of filenames.
5. Tap **OK** to save your changes.

Setting the Technician Name

The YBT250 allows you to store the name of the technician performing a test in the results file for the test.

To specify the technician's name:

1. Select **Setup > Edit**. This displays the Setup window.
2. Tap the **Save & Export** tab. See Figure 2-18.
3. Tap the box after **Technician:**.
4. Enter text (using the soft keyboard or an external keyboard) for the technician name. Of course, you can also use this space for additional test information instead of a technician name.
5. Tap **OK** to save the technician name.

When viewing a saved results file, you can view any saved notes, including Technician Name, by selecting **File > Results Properties**.

Entering Notes for Saved Results

The YBT250 allows you to enter note text to be saved in results files. Thus, if there are any special conditions about a test, you can save notes within the results file. You can enter up to 254 characters in the notes field.

To specify notes for saved results:

1. Select **Setup > Edit**. This displays the Setup window.
2. Tap the **Save & Export** tab. See Figure 2-18.
3. Tap the box after **Notes for saved results:**.
4. Enter text (using the soft keyboard or an external keyboard) for the note.
5. Tap **OK** to save the notes you entered.

When viewing a saved results file, you can view any saved notes by selecting **File > Results Properties**.

Setting Up a GPS Receiver

Refer to page 2-50 for information about selecting and setting up a Global Positioning System Receiver so that you can save GPS coordinates with your results.

Setting Default File Type

You can set the default file type for exported screens. You can also set the default file type for saved and exported results files.

To specify default file types:

1. Select **Setup > Edit**. This displays the Setup window.
2. Tap the **Save & Export** tab. See Figure 2-18.
3. In the drop down box **Default format for exported screens:**, select a file extension:
 - PNG files (*.png)
 - JPEG files (*.jpg)
 - Bitmap files (*.bmp)

NOTE. An exported screen cannot be displayed by the YBT250; it can be opened only by a program that can display graphic images.

4. In the drop down box **Default format for exported results**;, select a file extension:
 - Tab-separated (*.txt)
 - Comma-separated (*.csv)

Setting Default File Location for Automatically Saving and Exporting Spectrograms and Codograms

You can set the default location to which you save and export screens and results files for spectrograms and codograms. This feature can be useful when, for example, you are saving many spectrograms and codograms to a memory card.

To specify the location to which spectrograms and codograms are automatically saved or exported:

1. Select **Setup > Edit**. This displays the Setup window.
2. Tap the **Save & Export** tab. See Figure 2-18.
3. In the field **Codogram/Spectrogram Auto Saves**, look at the path. Tap the  icon to open the Input Panel to use the arrows on the Input Panel to view the whole path.
4. Enter a new path using the Input Panel, or tap the **Browse...** button to navigate to the location to which you want files saved.

NOTE. *Changes you make to the default location for auto saving and exporting spectrograms and codograms will persist when you next power-on the instrument.*

This control only sets the location of codogram and spectrogram auto saves. It does not set the default location for other saves or exports. When you start the YBT250 application, the default location for all saves and exports (except codogram and spectrogram auto save) is always \BuiltInDisk\YBT250\AppData\Results; after you have saved a file, the default location will be whatever location you used most recently.

Saving GPS Coordinates with your Results

You can connect a GPS receiver to your NetTek Analyzer to collect location coordinates which are saved with your measurement results when you save or export the results. At the time that you save or export your results, the most recent position read from the GPS receiver is included with your results.

NOTE. *For correct coordinates when using the GPS function, save or export your results while the GPS receiver is at the location where you made the test. (If you make a measurement, move the instrument, and then save your results, you will not be saving the coordinates of where you took the test. You will be saving the coordinates of your new location.)*

Selecting a Compatible GPS Receiver

You can use any GPS receiver that supports NMEA 0183 V2.0. Specifically, the GPS must output the \$GPRMC sentence on a regular basis.

The GPS position is read from the GPS receiver once per second by the YBT250 application, or at the rate the GPS receiver sends the \$GPRMC sentence, whichever is slower.

Connecting through the Serial Port. The GPS receiver can connect to the serial port (4800 baud rate). The Garmin GPS III and Garmin GPS III Plus have been tested with the YBT250 application.

Connecting through the PCMCIA Slot. The GPS receiver can connect through the PCMCIA slot and emulate a serial port on COM4. The Teletype GPS WorldNavigator (product #1351) has been tested with the YBT250 application.

Enabling Your GPS Receiver

To enable the GPS feature:

1. Set your GPS receiver to output NMEA sentences regularly.
2. Connect the GPS receiver (by cable or through the PCMCIA slot) to the NetTek Analyzer Platform.

3. In the YBT250 application, tap the **Edit** button and then the **Save & Export** tab.
4. From the drop down list box, select the correct GPS receiver interface type (Serial or PCMCIA) for your GPS.

If your GPS receiver is connected and is outputting the \$GPRMC sentence, after a short pause, the latitude and longitude will be displayed just to the right of the drop down list box. Tap the **Refresh** button to update the coordinates displayed here.

You can also view the latest GPS position in the Results Properties dialog box (**File > Results Properties**). When you open a saved results file, the Results Properties will show information about the results file, including the GPS position at the time the results file was saved.

Troubleshooting Your GPS Receiver

After you have selected the GPS receiver type in the Save & Export dialog box, a position should be read out immediately to the right of the list box.

Error Message: Invalid Position. If, after you select the GPS receiver type in the Save & Export dialog, the message “Invalid Position” appears, then the communication connection to the receiver has been successfully established, and the \$GPRMC sentence is being successfully read from the receiver, but the position supplied in that sentence is not valid. In this case, check your GPS receiver to see if it does have a valid position, and, if not, refer to the GPS receiver documentation to resolve this problem.

Error Message: Unable to Read Position Information If, after you select the GPS receiver type in the Save & Export dialog, an error dialog box appears indicating that the application was unable to read position information from the GPS receiver, then do the following:

- Make sure the cable from the receiver to the serial port is connected or that the PCMCIA card is firmly seated.
- Ensure that the receiver is set to output NMEA sentences regularly.

If you have purchased the vxHpc terminal emulator, you can view the NMEA sentences being sent.

Open the vxHpc terminal emulator by tapping **Start > Programs > Communication > vxHpc**.

To view the NMEA sentences being sent, you need to set up vxHpc to connect to the correct port:

- For a serial port GPS receiver, set up vxHpc to connect to COM1.
- For the Teletype WorldNavigator, set up vxHpc to connect to Teletype_1358.

Configure the port the as follows:

- 4800 baud
- 8 data bits
- No parity
- 1 stop bit
- No flow control

If you then open the session, you should see NMEA sentences being displayed from the GPS receiver.

If you do not see NMEA sentences, either they are not being sent by the GPS receiver or the connection to the GPS receiver is not passing them (check the cables again). Refer to your GPS receiver documentation to find out how to output NMEA sentences regularly.

vxHpc Software

The NetTek Analyzer includes a 30-day evaluation version of the vxHpc High Performance Serial and Telnet Communications Software from Cambridge Computer Corporation. vxHpc provides more sophisticated and powerful communications capability than the built-in Windows CE Terminal program. vxHpc provides a broad range of terminal emulations, includes telnet (TCP/IP) communications capability, terminal emulation over the serial port, file transfer and scripting. The vxHpc software is fully functional for 30 days after its first use, after which you will have to purchase a license from Cambridge Computer Corporation. For registration information, see the vxHpc online help: follow the Tips for using vxHpc link on the first page or go to <http://www.cam.com>.



Reference

Displaying a Signal Spectrum

You can use the YBT250 Field Transmitter & Interference Tester to display the spectrum of a signal and a spectrogram of a signal. The spectrum display shows the signal level at different frequencies, all at once. The spectrogram display shows how the signal level varies over time. A spectrogram shows the history of the signal. The spectrogram display is accessible only if the Interference option is installed (Option IN1, Interference Analyst).

The Spectrum Display Area

There are several buttons located in the Spectrum area display. Figure 3-1 shows a typical spectrum display (with Interference option installed).

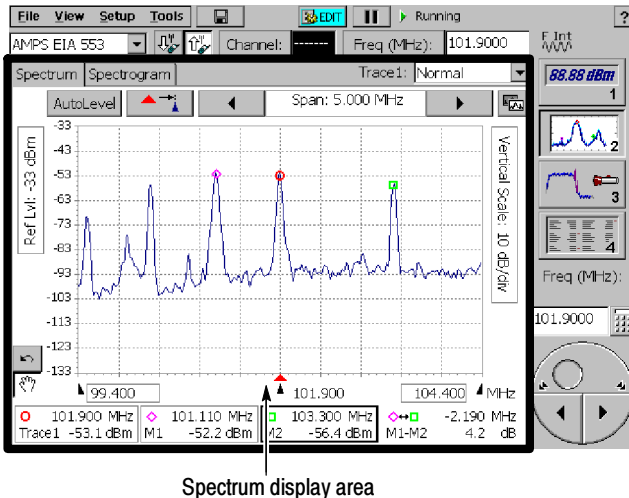

Figure 3-1: A typical Spectrum display

Table 3-1 lists each of the buttons that can appear in the spectrum display and explains what each button does.

Table 3-1: Spectrum and Spectrogram window buttons and icons









| Button | Function |
|---|---|
|  | This tab selects the normal spectrum display. |
|  | This tab selects the spectrogram display (requires Option IN1, Interference Analyst). |
|  | This drop-down list specifies the trace type. See Table 3-2. |
|  | This button clears the trace and restarts acquisition when Trace is set to Average, Min, Max, or Min & Max Hold. Present in both the Spectrum and Spectrogram displays. This button also clears and restarts the spectrogram. |
|  | Adjusts the internal gain and /or attenuation (Ref Level) to provide an optimized waveform display and prevent overload conditions. |
|  | Moves the measurement frequency to the horizontal center of the display. |
|  | Decreases the span (frequency width) of the spectrum and spectrogram displays. |
|  | Increases the span of the spectrum and spectrogram displays. |
|  | Rotate trace order: Moves the front trace to the back or enables Trace 2 if not displayed. |

Table 3-1: Spectrum and Spectrogram window buttons and icons (Cont.)

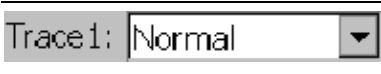

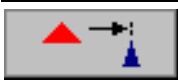



| Button | Function |
|--|--|
|  | Indicates the current Reference Level (top of the display in spectrum windows). |
|  | Displays current vertical scale setting. |
|  | Indicates the Start frequency (the lowest displayed frequency). |
|  | Indicates the Center frequency (the middle displayed frequency). |
|  | Indicates the Stop frequency (the highest displayed frequency). |
|  | Undo Tap moves the waveform in the display back to its previous position or resets the value of the last item touched in the graph. Present only when an action can be undone. |
|  | Allows the user to alter settings by tapping in the graph area. When visible, the waveform in the display can be moved and markers can be placed by tapping the graph. |

Table 3-1: Spectrum and Spectrogram window buttons and icons (Cont.)

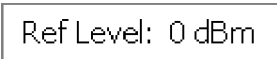
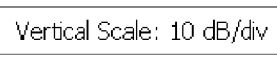
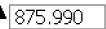
| Button | Function |
|---|--|
|  | <p>Prevents the waveform in the display from being moved accidentally. When visible, the waveform in the display cannot be moved and markers cannot be placed by tapping the graph (they can still be moved using other controls).</p> |
|  | <p>Indicates how to interpret the power values of channel data in the Spectrogram.</p> |

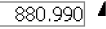

Displaying a Trace

To display a spectrum trace:

1. Connect a signal (see page 2-23) from a test port to the YBT250 RF INPUT connector.
2. If there is no test port:
 - a. Verify the transmitter is not transmitting power to the antenna.
 - b. Disconnect the transmitter cable from the antenna.
 - c. Attach an attenuator to the cable output (this will prevent overpowering the input of the YBT250).



CAUTION. *If the input of the YBT250 is accidentally overpowered, it will trip an internal protection switch. A dialog box will inform you that to continue using the YBT250, you must disconnect the input cable or reduce the input power and then press OK.*

- d. Connect the attenuator to the YBT250 input connector.
3. Select the Signal Standard.
4. Select the Channel.
5. Select Forward () or Reverse Link () .
6. Select the Spectrum display (button 2). See Figure 3-2.

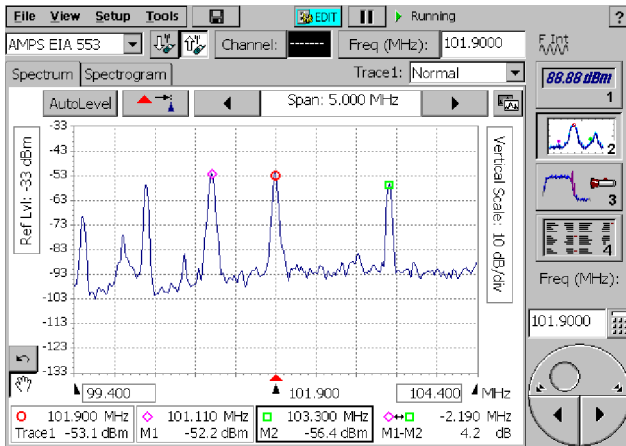

Figure 3-2: A spectrum trace with markers displayed

Setting Trace Display Options

You can change how a trace is displayed to make it easier to analyze. There are five trace types you can choose from. See Table 3-2.

Table 3-2: Trace display options

| Trace type | Description |
|------------|---|
| Normal | Each point in the trace represents a single acquisition. Updates display with each new acquisition. |
| Average | Each point in the trace represents an average of a number of acquisitions. The number of acquisitions averaged is set on the Spectrum tab of the Settings page. |
| Min Hold | Each point in the trace represents the minimum amplitude measured at that frequency since the acquisition was started. Acquisition can be restarted by tapping the restart button. Updates displayed point only if new point < old point. |

Table 3-2: Trace display options (Cont.)

| Trace type | Description |
|--------------|---|
| Max Hold | Each point in the trace represents the maximum amplitude measured at that frequency since the acquisition was started. Acquisition can be restarted by tapping the restart button. Updates displayed point only if new point > old point. |
| Min/Max Hold | This is a combination of Min Hold and Max Hold. Each point in the trace has both a minimum and maximum value that correspond, respectively, to the minimum and maximum values measured at that frequency since the acquisition was started. Acquisition can be restarted by tapping the restart button. Draws a vertical line between Max Hold and Min Hold points. |

Setting the Trace Type

The usual trace type is Normal. However, you can set the trace type to any of the other four trace types.

To specify the trace type:

- Select the desired trace type from the drop-down list. See Figure 3-3.

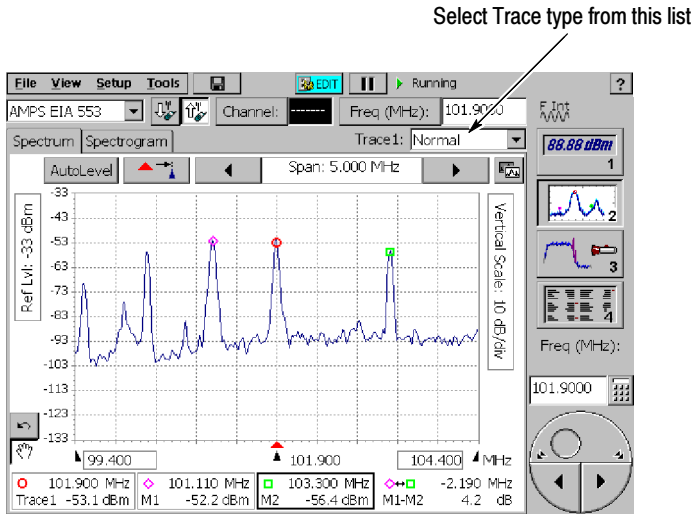

Figure 3-3: Setting the trace type

You can also set the trace type in the Setup window:

1. Select **Setup** > **Edit**. This displays the Setup window.
2. Tap the **Spectrum** tab. See Figure 3-4.
3. Select the desired trace type from the drop-down list.

If you select **Average**, you can also set the number of traces averaged together to create the trace display. The default number of averages is 5. This number applies to both Trace 1 and 2.

- a. To set the number of averages, tap the keypad next to the number of averages.
 - b. Enter the number of traces to average and then tap **OK**.
4. Tap **OK** to save your changes.

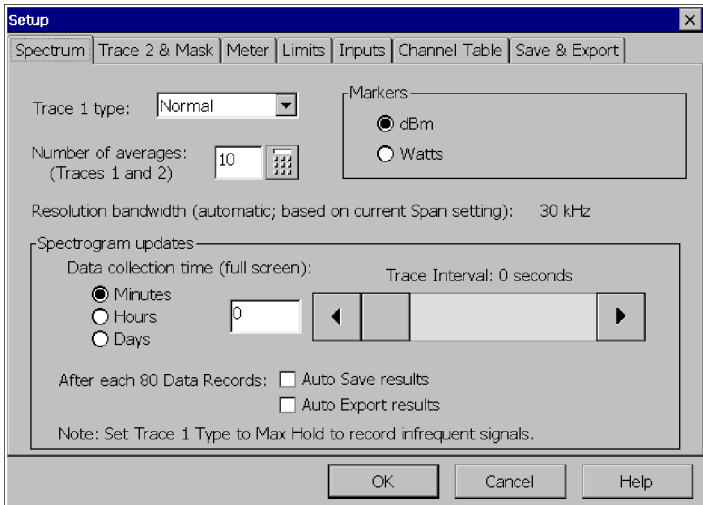

Figure 3-4: The Spectrum tab

Changing the Vertical Scale of the Spectrum Display

To change the vertical scale of the display (dB/div):

1. Tap the Vertical Scale label to assign Vertical Scale to the knob.
2. Change the vertical scale by:
 - a. Tapping the numeric entry keypad button and entering a new value, or
 - b. Tapping the left/right arrows below the knob to change the vertical scale value, or
 - c. Dragging the top portion of the knob to set the new value.

When the vertical scale is set to a value that causes the trace to expand beyond the display area, a scroll bar appears at the right side of the trace display. You can change the position of the trace by dragging the scroll bar or tapping the scroll bar's arrows.

Changing the Vertical Position of the Trace

The vertical position of the trace can be changed only when the vertical scale is <10 dB/div.

To change the vertical position of the trace:

- Drag the vertical scroll bar (only visible when the vertical scale is <10 dB/div) or tap the arrows at the ends of the scroll bar. See Figure 3-5.

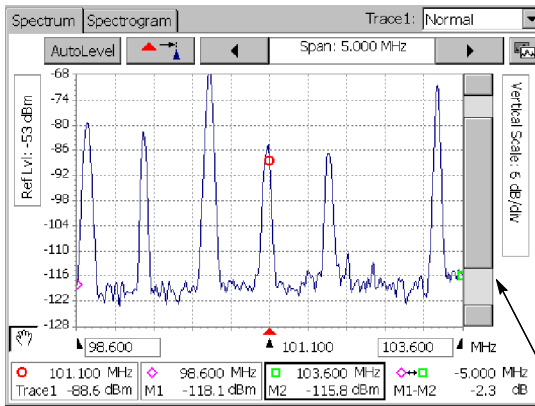

Display scroll bar

Figure 3-5: How the display appears with a small vertical scale value

Changing the Horizontal Position of the Trace

To change the horizontal position of the trace:

- Touch inside the graph, and keeping your finger on the screen, drag the trace to the desired position. You do not have to touch the trace itself.

If you just tap the waveform and remove your finger, the trace will not move. If Markers are on, the position of the selected Marker will change to the location you tapped. If Markers are off, when you tap

the waveform, the measurement frequency will change to the frequency at the point you tapped.

Changing the Reference Level

The Reference Level is the level displayed at the top of spectrum windows.

To change the Reference Level:

1. Tap the **Ref Lvl** label to assign the knob to Reference Level.
2. Change the Reference Level by:
 - a. Tapping the numeric keypad button and entering a new value, or
 - b. Tap the left/right arrows on the bottom half of the knob to change the Reference Level value, or
 - c. Drag the circle on the top half of the knob to set the new value.

Disabling Tap/Drag Operation

You can prevent the accidental change of settings or movement of the trace by disabling Tap/Drag actions within the trace area of the display.

To disable tap/drag action:

- Tap the Tap/Drag Enabled button  .

When Tap/Drag action is disabled, the icon changes to .

To enable tap/drag action:

- Tap the Tap/Drag Disabled button .

Saving Traces

You can save a trace for later recall. For example, you can save an example of a good trace for comparison with a live trace later.

To save a trace with an automatically generated filename:

- Select **File > Save Trace**.

When you start the application, traces are saved in the \BuiltInDisk\YBT250\AppData\Results directory by default. Refer to *Changing Settings for Saved Files* on page 2-45 for information on changing the default directory and setting other defaults for saved files. You can also change the directory for future save operations by selecting a different path in the Save Trace As window, but the default will return to the \BuiltInDisk\YBT250\AppData\Results directory when you restart the application.

NOTE. *Only traces saved within the BuiltInDisk folder (or on a removable storage device such as a PC memory card) are stored in non-volatile memory. Traces saved outside the BuiltInDisk folder are lost when the YBT250 is shutdown.*

To save a trace with a name and location you specify:

1. Select **File > Save Trace As**. The Save As dialog box appears.
2. Enter a name and location for the file and tap **OK**.

NOTE. *Traces are saved with the settings in effect at the time the trace is saved.*

You can save GPS coordinates with your results. Refer to page 2-50 for information about selecting and setting up a Global Positioning System Receiver.

Displaying a Saved Trace

You can display a previously saved trace for review or comparison with another trace.

To display a saved trace:

1. Select **File > Open**. The Open dialog box appears.
2. Locate the saved trace, tap the name of the trace and then tap **OK**.

NOTE. *Traces are saved with the settings in effect at the time the trace is saved. When a saved trace is displayed, the stored settings values will be shown for reference, though no actual instrument settings will change. As soon as you press  to return to making new acquisitions, the settings will be restored to what they were before the saved trace was opened.*

Comparing Traces

The YBT250 provides the ability for you to visually compare the current trace against a reference trace. The reference trace, called Trace 2, can be another current trace or a saved trace.

To display a second trace:

- Select **View>Trace 2**.

or

- Select the Rotate Traces icon .

If Trace 2 is not enabled, selecting the Rotate Trace icon enables the Trace 2 display.

Defining Trace 2

Trace 2 can be a live trace (for example, an averaged display of the latest acquisitions) or a saved trace.

To define Trace 2:

1. Select **View>Define Trace 2...** The Settings window appears with the Trace 2 & Mask tab selected. See Figure 3-6.

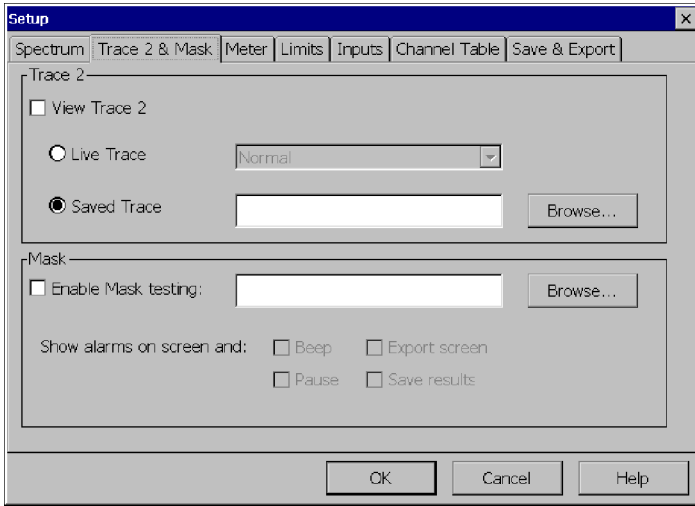

Figure 3-6: Defining Trace 2

2. To set Trace 2 to a version of the live trace, select **Live Trace** in the Trace 2 box.

You can set the trace display options for Trace 2 with the drop-down list. You can choose Normal, Average, Min Hold, Max Hold, or Min/Max Hold.

3. To set Trace 2 to a saved trace, select **Saved Trace**. Enter the path to the saved trace in the input box, or tap **Browse** to display the Open dialog box.

Comparing Two Trace Results Files

To compare two saved results:

1. Select **File > Compare Saved....** The Open dialog appears. See Figure 3-7. For the first result selected, the dialog is labeled **Select first result file to compare**.

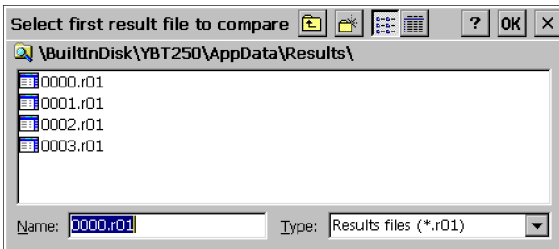

Figure 3-7: Selecting the first result file

2. Select the first result file you wish to compare.
3. Tap **OK**. The trace stored in this file is displayed as Trace 1.
4. After you select the first result, use the **Select second result file to compare** dialog box (shown in Figure 3-8) to select the second trace file.

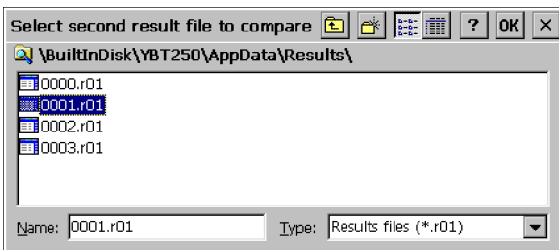

Figure 3-8: Selecting the second result file

5. Tap **OK**. The trace stored in this second file is displayed as Trace 2.

The timestamp displayed next to the Open Folder indicator on the toolbar is associated with the trace file that is displayed in the foreground.

The two traces are displayed in different colors so that they are easier to compare. You can use markers on the saved traces to compare points on the traces. See Figure 3-9.

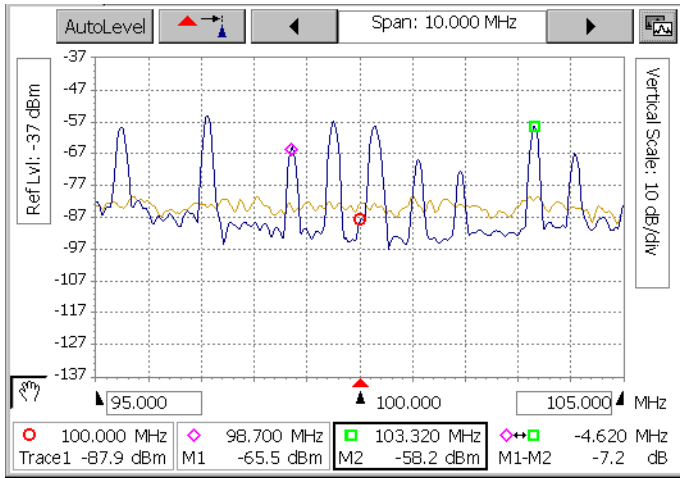

Figure 3-9: Two compared traces

Displaying Markers

The YBT250 Field Transmitter & Interference Tester uses markers to measure differences in the frequency and level of the displayed trace.

To display the markers:

- Select **View>Markers**.

The markers will be displayed as shown in Figure 3-10.

NOTE. Markers can be viewed only in the Spectrum display. Markers are not available in any of the Interference or Measure windows.

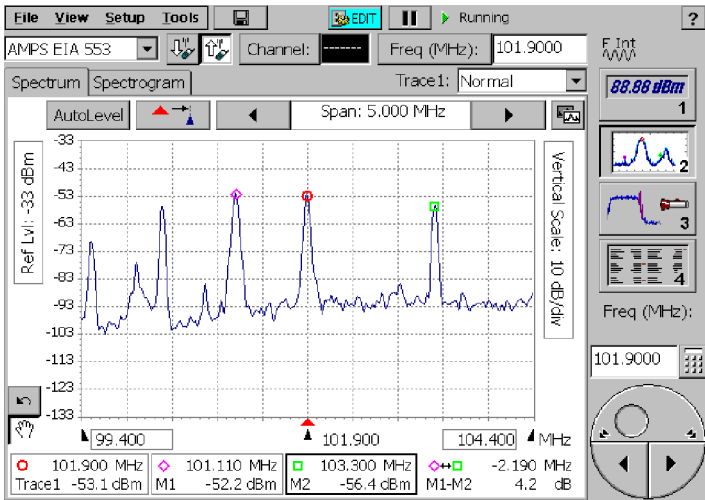

Figure 3-10: Display with markers

There are four readouts associated with markers. See Figure 3-11.

- Measurement Frequency level and frequency
- Marker 1 (M1) frequency and level
- Marker 2 (M2) frequency and level
- Difference in frequency and level between M1 and M2 (M1-M2) (when mask testing *is not* enabled) OR
- Difference in level between M1 and a Mask and M2 and a Mask (when mask testing *is* enabled)

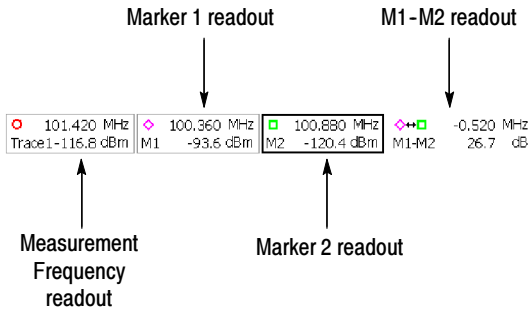

Figure 3-11: The four readouts of the Markers display

The units for the frequency and level readouts are located at the right side of each segment of the marker display (for example, MHz and dBm). The elements of each marker display are shown in Figure 3-12.

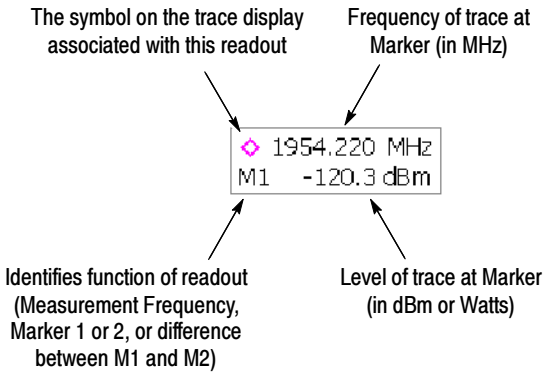

Figure 3-12: Parts of the Marker readout

Specifying Units for Marker Display

The units displayed in the marker readouts for level can be set to either dBm or Watts.

To change the marker readout units for level:

1. Tap the Edit button or select **Setup > Edit**. This displays the window shown in Figure 3-13.
2. To set the units for level in the marker readouts, tap **dBm** or **Watts** in the Markers box.
3. Tap **OK** after setting the units.

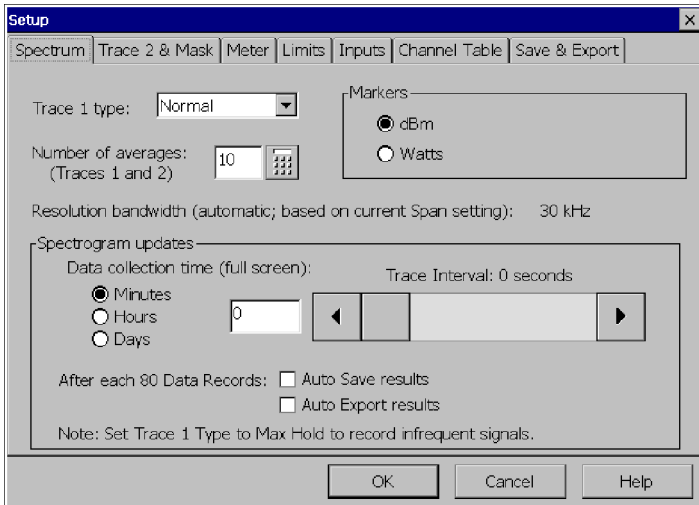

Figure 3-13: Changing Units for Marker Level

Measuring Frequency and Level Differences on a Single Trace

To measure the difference in frequency and level between two points on a single trace:

1. Display the markers by selecting **View>Markers**.
2. Tap the **M1** readout. This assigns the marker to the knob and to the touch screen in the display area.
3. Tap the display where you want to place the marker. You can also use the knob to position the marker.
4. Tap the **M2** readout. This assigns the marker to the knob and to the touch screen in the display area.
5. Tap the display where you want to place the marker. You can also use the knob to position the marker.
6. Read the difference in frequency and level at the right side of the marker display.

Measuring Frequency and Level Differences Between Two Traces

When Trace 2 is displayed, you can measure the difference in frequency and level between points on two traces:

1. If Trace 2 is not displayed, select **View > Trace 2**.
2. Display the markers by selecting **View > Markers**.
3. Specify the location of the markers by choosing one of the menu selections shown in Table 3-3 from the **View** menu.

Table 3-3: Marker placement

| Menu selection | Location of markers |
|-------------------------------|---|
| M1 Trace 1, M2 Trace 2 | Assigns M1 to Trace 1 and M2 to Trace 2 (rotating the trace order does not change the marker assignment). |
| Both on front trace | Both markers are assigned to the front trace, which changes when the trace order changes. |
| Both on Trace 1 | Both markers remain on Trace 1 (rotating the trace order does not change the marker assignment). |
| Both on Trace 2 | Both markers remain on Trace 2 (rotating the trace order does not change the marker assignment). |

4. Tap the **M1** readout. This assigns the marker to the control knob and to the touch screen in the display area.
5. Tap the display where you want to place the marker. You can also use the knob to position the marker.
6. Tap the **M2** readout. This assigns the marker to the knob and to the touch screen in the display area.

7. Tap the display where you want to place the marker. You can also use the knob to position the marker.
8. Read the difference in frequency and level at the right side of the marker display.

Markers and Mask Testing

Markers are available when mask testing is enabled. There are two things to note about markers when mask testing is enabled:

- Markers cannot be placed on a mask.
- When mask testing is enabled, the marker difference readout displays the difference between the marker and the mask.

Refer to page 3-33 for more information about mask testing and markers.

Band Edge Cursor

The Band Edge cursors identify the start and stop frequencies for the transmit or receive bands of the selected standard. See Figure 3-14. (Transmit or receive band is selected using the Uplink and Downlink buttons.) There are two parts to the cursors, the main part appears in the main trace display and the second part appears along the top edge of the graph. The portion in the main display can be switched off, but the part along the top edge of the graph is always visible. See Figure 3-15.

To turn on the display of Band Edge Cursors:

- Select **View > Band Edge Cursor** so that it is checked. See Figure 3-14 on page 3-23.

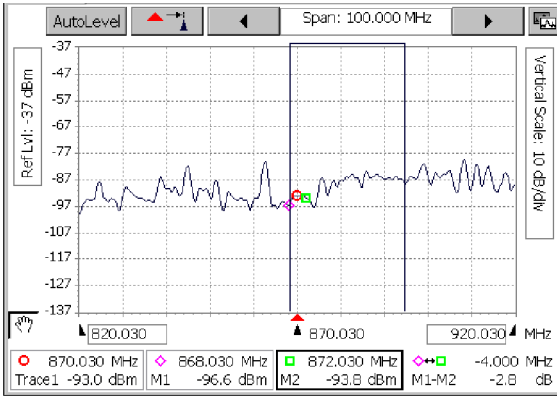

Figure 3-14: Band Edge Cursor displayed

To turn off the display of Band Edge Cursors:

- Select **View > Band Edge Cursor** so that it is *not* checked. See Figure 3-15 on page 3-23.

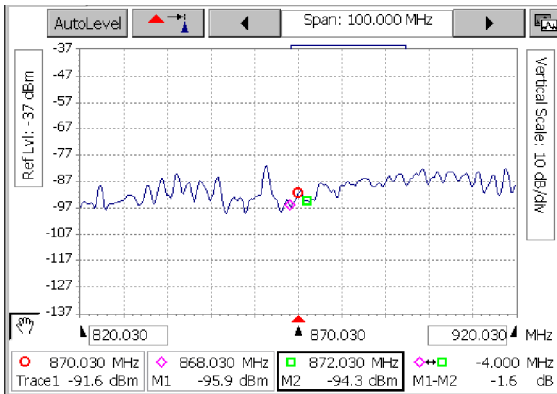

Figure 3-15: Band Edge Cursor turned off; top part visible

Displaying a Spectrogram

Requires Option IN1, Interference Analyst

A spectrogram displays the record of signal level over time. This history of the signal levels enables you to see changes in the signal that cannot be seen in any other way. See Figure 3-16.

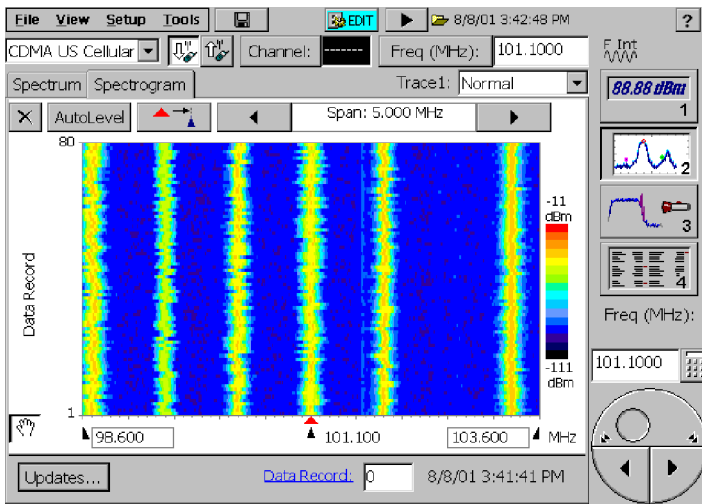

Figure 3-16: A spectrogram

To display a spectrogram:

1. Select the Spectrum display (button 2).
2. Set the Frequency, Span, Reference Level and Vertical Scale to show the signal(s) of interest in the graph.
3. Select the Spectrogram tab.

Remember the following while viewing a spectrogram:

- Select the Restart icon to clear the trace history and restart collecting data (✕).

- Select **Updates...** to change how often the spectrogram is updated.
- You can determine when an anomaly occurred in the spectrogram by displaying a cursor. To display the cursor, enter the number of a data record (1–80) in the Data Record box at the bottom of the display. The cursor is a white band of the same height as a data record. Use the knob or numeric keypad to move the cursor so that it covers up the data record of interest. The time and date the data was recorded is displayed to the right of the Data Record box.
- To create a spectrogram that uses the full range of colors, adjust the Vertical Scale and vertical position in the spectrum display so that the trace fills at least eight vertical divisions.
- A banner “Input Overrange: Reduce input signal level” will appear below the spectrogram when input levels are too high. A red mark also appears to the right of a spectrogram record to indicate that the spectrum was acquired during an Input Overrange condition. When a Spectrogram is acquired during an Input Overrange condition, the resulting trace data may still be valid, but it may also contain IM (Inter-Modulation Distortion) products that are internally generated.

The Input Overrange information is saved with and exported with the results.

See *Locating Intermittent Interference* on page 3–44, for more information on using the Spectrogram window.

Setting the Spectrogram Update Rate

The YBT250 allows you to set the rate at which a spectrogram is updated. Setting the spectrogram update rate specifies how often the Spectrogram display receives a new trace.

To specify the spectrogram update rate:

1. Select **Setup > Edit**. This displays the Setup window.
2. Tap the **Spectrum** tab. See Figure 3–17.

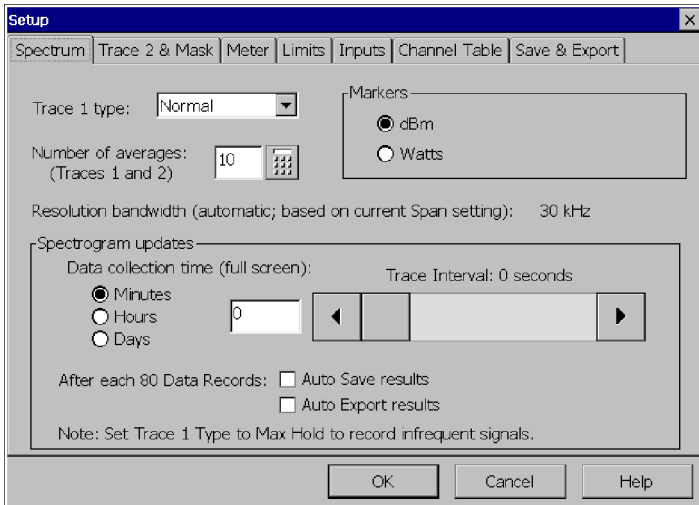

Figure 3-17: The Spectrum tab

3. Specify the full-screen data collection time by selecting either **Minutes**, **Hours** or **Days**.
4. Adjust the slider control to set the data collection time (that is, the time used to fill the spectrogram display). You change the data collection time by moving the slider, tapping the left/right arrow buttons, or typing in the number with the soft keyboard.

Automatically Saving and Exporting the Spectrogram Display

You can set YBT250 to save or export the spectrogram display each time 80 records are accumulated. Files are automatically named as they are saved, enabling unattended operation.

For a general discussion of saving and exporting, refer to *Saving, Exporting, and Recalling Results, Traces, and Settings* on page 3-123. For a general discussion of how to set defaults for

saving or exporting files, refer to *Changing Settings for Saved Files* on page 2-45.

To automatically save or export the spectrogram display every 80 records:

1. Select **Setup > Edit**. This displays the Setup window.
2. Tap the **Spectrum** tab. See Figure 3-17.
3. To automatically save and / or export, tap the check boxes next to **Auto Save** and / or **Auto Export**.
4. Tap **OK** to save your changes.

The YBT250 will save or export the spectrogram display to a new file each time 80 data records are accumulated. The time required to accumulate 80 records depends on the spectrogram update rate. The size of a full, saved spectrogram file is about 43 kilobytes. The size of a full, exported spectrogram file is about 160 kilobytes.

Creating a Mask

Mask testing is used to determine if a signal exceeds specified levels. The YBT250 can perform several actions when an input signal exceeds limits defined by a mask. The default action is to display an icon (!A) to the right of the graph (which cannot be switched off) and sound a beep (which can be switched off). A trace that exceeds limits can trigger additional actions such as pausing the display, exporting a screen and saving results to a file.

Masks are created with the Mask Maker utility. A mask consists of one or more traces. Each trace consists of at least one point.

To create a mask:

1. Select the Spectrum display.
2. Set the measurement frequency to the center of the spectrum graph by tapping the move to center icon ()
3. From the **Tools** menu, select **Mask Maker**. This displays the Mask Maker utility. See Figure 3-18.

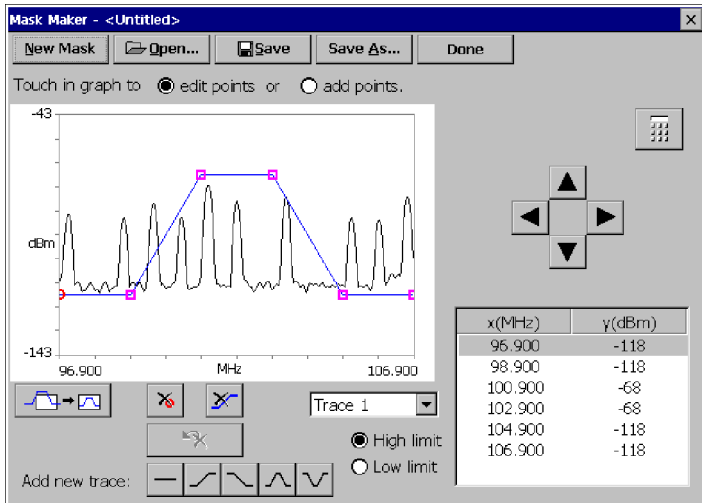

Figure 3-18: The Mask Maker utility

If Mask testing was already enabled for the Spectrum display, the selected mask is displayed in the Mask Maker window. If Mask testing was not enabled, a new default mask (the pulse-shaped trace) is displayed.

To add a point to a trace:

1. If more than one trace is displayed, select the desired trace by tapping on it or tap the down arrow (Trace 1) on the trace selector and select the desired trace from the list.
2. Tap the **add points** option button above the graph.
3. Tap the graph at the desired point.

To move a trace point:

1. If more than one trace is displayed, select the desired trace by tapping on it or tap the down arrow (Trace 1) on the trace selector and select the desired trace from the list.

2. Tap the **edit points** option button above the graph.
3. Touch the desired point and drag it to the new location.

Alternately, you can move points by using the keypad or the cursor keys:



1. Tap the value in the table (the number in either the **x(MHz)** column or the **y(dBm)** column) you want to adjust.
2. If the cursor arrows are displayed above the table, tap the keypad icon () to display the keypad.
3. Use the keypad to type the new value for the point and tap **Enter** when finished.

NOTE. *If you want to adjust a vertical value, you can tap the desired point in the graph and its vertical value will be selected in the table.*

or:

4. Tap the point to be moved so it is selected (point indicator changes to a circle).
5. If the keypad is displayed above the table, tap the cursor arrows icon () to display the cursor arrows. Tap one of the cursor arrows to move the selected point in the desired direction.

To delete a point from a trace:

1. If more than one trace is displayed, tap the down arrow () on the trace selector. Select the desired trace from the list.
2. Tap the point to be deleted so it is selected (point indicator changes to a circle).
3. Tap the delete point button ()

To add a trace to the mask:

- Tap one of the **Add new trace** buttons. A trace of the selected shape will appear on the graph.

To delete a trace from a mask:

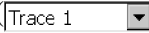
1. Tap the down arrow () on the trace selector.
2. Select the trace to delete from the list.



If the **edit points** option button is selected, you can also select a trace by touching it near one of its points.

3. Tap the delete trace button ()

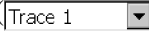
To specify how a mask violation is determined:

1. Tap the down arrow () on the trace selector.
2. Select the desired trace from the list.
3. Tap **High limit** to indicate a violation when a signal trace has a value higher than the mask trace.
4. Tap **Low limit** to indicate a violation when a signal trace has a value lower than the mask trace.

Hints

- The selected point on a mask trace is indicated by a circle. Other points are indicated by a square.
- You can add as many points as you want to a mask trace.
- You can place as many traces on a mask as you want.
- If you place points outside the visible area of the graph, tap the rescale button () to bring all points into view.
- If you accidentally delete a point or a trace, you can undo the last delete action by tapping the Undo Delete button ()



- Tap the numeric keypad () to switch to the numeric keypad from the cursor keys.
- Tap the cursors keys button () to switch to the cursor keys from the numeric keypad.

Table 3-4: Mask maker buttons and icons

















| Button/Icon | Description |
|---|---|
|  | Creates a new mask. |
|  | Opens an existing mask for editing. |
|  | Saves changes to the current mask. |
|  | Save changes to the current mask with a different name or to a different location. |
|  | Cursor arrows button. Tap to display the cursor arrows. |
|  | Cursor arrow. Tap to move the selected point in the desired direction. |
|  | Keypad button. Tap to display the numeric keypad. |
|  | Done. Tap to exit the Mask Maker utility. |
|  | Rescale button. Tap to scale the current mask so all points are visible in the graph. |
|  | Delete Point. Tap to delete the selected point from the mask. |
|  | Delete Trace. Tap to delete the selected trace from the mask. |
|  | Trace Select list box. Tap to select which trace to edit. |
|  | Undo Delete. Tap to undo the last Delete Point or Delete Trace action. |

Table 3-4: Mask maker buttons and icons (Cont.)

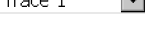
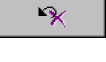
| Button/Icon | Description |
|---|--|
|  | Flat Trace button. Tap to add a 2-point trace to the mask. |
|  | Rising Trace button. Tap to add a 4-point trace to the mask. |
|  | Falling Trace button. Tap to add a 4-point trace to the mask. |
|  | Positive Pulse button. Tap to add a 6-point trace to the mask. |
|  | Negative Trace button. Tap to add a 6-point trace to the mask. |

Defining a Mask

Before you can perform a mask test, you must define the mask to be used. If you have not yet created a mask, see *Creating a Mask* on page 3-27.

To define a mask:

1. Select **View > Define Mask**. This displays the **Trace 2 & Mask** tab of the Setup window.
2. In the **Mask** section of the tab, tap **Browse** and select the mask you want to use for your mask test.
3. Tap the **Enable Mask Testing** check box.
4. To have the YBT250 perform an action (in addition to displaying the violation icon) when a mask violation occurs, tap the appropriate check box:
 - Tap **Beep** to sound an alarm when a violation occurs (this is selected by default).
 - Tap **Pause** to cause the YBT250 to pause when a violation occurs.

- Tap **Export Screen** to save the screen as a graphics file when a violation occurs.
 - Tap **Save Results** to cause the YBT250 to save the measurements results to a file when a violation occurs.
5. Tap **OK** to accept your changes.

Mask testing is enabled with the defined mask displayed.

Performing a Mask Test

To perform a mask test:

- Select **View > Mask** so that there is a check mark next to **Mask**.

The defined mask is displayed, with the mask centered on the current Measurement Frequency.

If the signal trace exceeds the mask, the violation icon () will appear on the right side of the spectrum graph and the violated mask trace will change color (the specific color depends on the selected color scheme).

A mask trace does not have to cover the entire frequency range of a graph. Signal points at frequencies that don't have associated mask points are not tested for violations. This allows you to check only those parts of the signal that are critical to your specific measurement, for example the attenuation in adjacent channels.

Mask Testing and Markers

When Mask testing is enabled, the marker difference readout displays the difference between the marker and the mask. A positive value indicates a “pass.” A negative value indicates a “fail.” A positive value for an upper limit means that the signal level is lower than the mask level at the marker frequency. A negative value means the signal level is higher than the mask level, thus violating the mask. For a lower limit mask, a positive difference means the signal level is higher than the mask level and a negative difference means the signal level is lower than the mask level.

The YBT250 calculates the difference between the marker and the mask using the above rule to determine the sign of the difference. The YBT250 calculates the difference between the signal level and the level of each of the traces in the mask. The YBT250 then displays the worst case difference between the signal level and all the traces in the mask.

For example, suppose there are two traces in a mask; one is an upper limit and the other is a lower limit. The upper limit mask trace level at the marker frequency is 0 dBm, the signal level is -10 dBm and the lower limit mask trace level is -30 dBm. Thus, the difference between the upper limit and the signal level is 10 dB, and the difference between the signal level and the lower limit is 20 dB. The YBT250 displays the M1 marker difference as 10 dB because the signal is closer to the upper limit than it is to the lower limit.

As another example, assume the upper limit mask trace level is 0 dBm, the signal level is -30 dBm and the lower limit mask trace level is -25 dBm. Therefore, the difference between the upper limit and the signal is 30 dB and the difference between the signal level and the lower limit is -5 dB. The YBT250 displays the M1 marker difference as -5 dB because the signal is closer to the lower limit than it is to the upper limit. And because the signal is lower than the lower limit, the signal fails the mask test.

If the YBT250 displays dashes (---) for the marker difference instead of a number, it means there is no mask defined at the marker frequency.

Locating Interference

To locate interference, you need Option IN1 Interference Analyst or Option WS1 W-CDMA Scrambling Code Analyzer).

The YBT250 Field Transmitter & Interference Tester provides several methods to locate and identify many types of interfering signals. The YBT250 can identify interference signals, demodulate AM or FM audio signals, assess the strength of an interfering signal, and measure the noise floor on receive channels.

The Interference Display Area

Requires Option IN1, Interference Analyst

There are several tabs, buttons and icons located in the Interference display area. Figure 3-19 shows a typical Interference display.

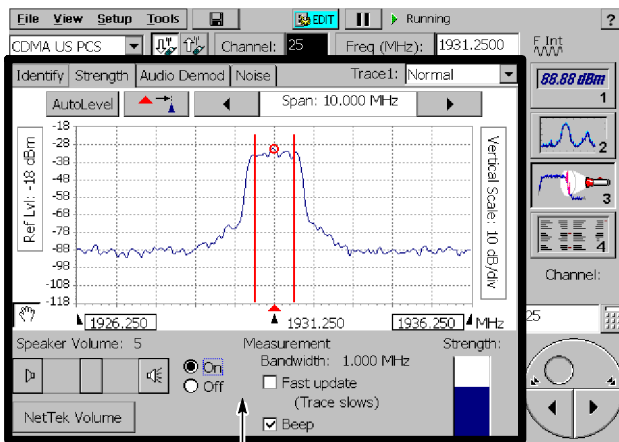

Interference display area

Figure 3-19: The Interference Strength display

Table 3-5 lists each of the buttons/icons that can appear in the Interference display and it explains what each button does.

Table 3-5: Interference window buttons and icons









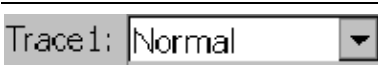

| Buttons/Icon | Function |
|---|---|
|  | This button starts the automatic identification function (Identify window only). |
|  | This scrollbar is used to adjust the volume of the speaker when listening to demodulated signals (Strength and Audio Demod windows only). |
|  | This drop-down list specifies the trace type |
|  | This button restarts trace acquisition when Trace is set to Average, Min, Max or Min/Max. |
|  | Adjusts the Reference Level to provide an optimized waveform display and prevent overload conditions. |
|  | Moves the trace so the measurement frequency is at the horizontal center of the spectrum graph. |
|  | Decreases the span of the trace display. |
|  | Increases the span of the trace display. |
|  | Undo reverses the most recent tap or drag action. Only visible after a tap or drag action. Displayed in graph area only. |

Table 3-5: Interference window buttons and icons (Cont.)

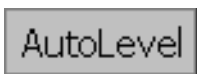
| Buttons/Icon | Function |
|---|---|
|  | Enables Tap or Drag actions (graph area only). |
|  | Disables Tap or Drag actions (graph area only). |

Displaying a Trace

To begin searching for an interfering signal, you usually begin by displaying a spectrum trace.

To display a spectrum trace:

1. Connect the signal from an antenna to the YBT250 RF INPUT.
2. Select the Interference display (). See Figure 3-20.

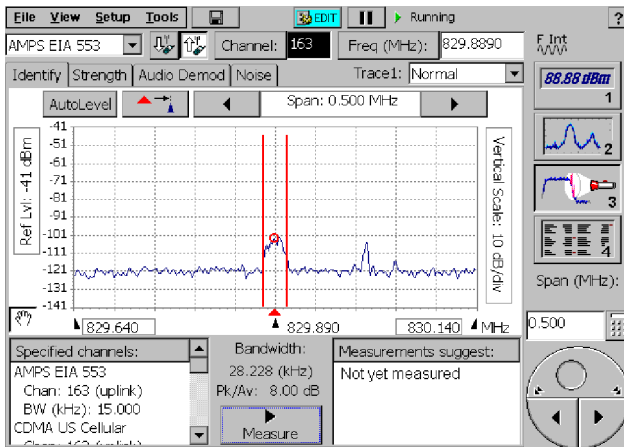



Figure 3-20: A trace spectrum in the Interference window

3. Select the Signal Standard.
4. Select the Channel.
5. Select Forward () or Reverse () Link.

Identifying a Signal

Requires Option IN1, Interference Analyst

Once you can see a signal that you think may be interfering, you can use the automated identification function to identify the signal. The YBT250 will make an estimate of the signal type, choosing between GSM, cdmaOne/cdma2000/1xEV-DO, W-CDMA, IS-136, and analog FM signal types.

1. In the Interference display (button 3), tap the **Identify** tab if needed.
2. Look at the spectrum display to locate the suspected interfering signal. Tap the trace at the frequency of the interfering signal to set the measurement frequency. Try to set the Measurement Frequency to the center of the signal.
3. Look at the **Assignments for this Freq.** readout at the lower left of the display. See Figure 3-20.

This readout displays the signal standard (more than one might be displayed) that has channels defined at the measurement frequency. The YBT250 first looks at the list of preferred signals and then looks at the global channel reference to check for a match. If the Measurement Frequency does not match with a supported standard, *Not Found* is displayed.

4. Select **Measure** to invoke the Identify function.

The YBT250 will perform a series of measurements to identify which signal standard the signal's characteristics most closely match. The results of the Identify function are displayed in the **Measurements suggest** results box. The signals are sorted by frequency, with the signal that most closely matches the measurement frequency listed first. See Figure 3-21.

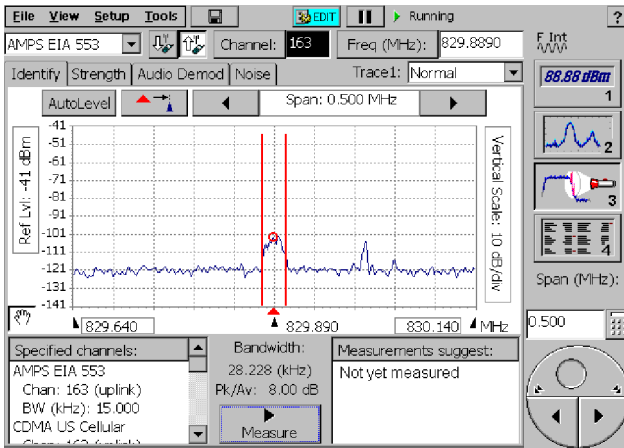

Figure 3-21: Results of an identification test

Locating an Interfering Signal

Requires Option IN1, Interference Analyst

By attaching a directional antenna to the YBT250, you can locate the source of an interfering signal by measuring the strength of the interfering signal. Figure 3-22 shows an example of a signal strength display.

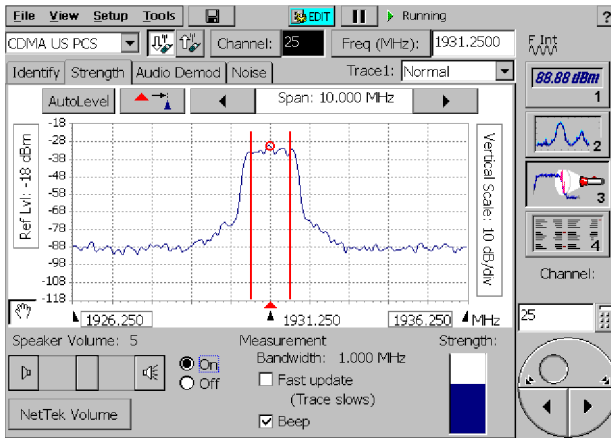

Figure 3-22: Example of a signal strength display

The Measurement Bandwidth, shown below the graph area in Figure 3-22, is the frequency range that fits within one horizontal division around the Measurement Frequency. You can change the span to adjust the Measurement bandwidth.

The YBT250 indicates signal strength two ways. One indicator is the **Strength** graph located at the bottom-right of the results display area. The second indicator is an audible tone or beep.

The Strength graph indicates the signal power detected within the Measurement Bandwidth. As the signal strength increases, the bar on the Strength graph rises.

The audible tone changes pitch as the signal strength changes. The higher the pitch, the stronger the signal. The audible tone is switched on and off by selecting **On** or **Off**, below the trace display. You can change the volume of the audible tone using the slider control at the bottom-left of the results display area.

The Beep causes the audible tone to switch on and off at a rate that varies with the signal strength. The faster the audible tone beeps, the stronger the signal. The Beep is activated by selecting the **Beep** checkbox located at the bottom-center of the results display area.

You can increase the rate at which the signal strength indicators are updated by selecting the **Fast Update** checkbox. When Fast Update is checked, the trace update rate is slowed so that the strength measurement can speed up. The variation in pitch of the audible tone (and Beep if it is selected) occurs much faster when Fast Update is enabled.

To locate an interfering signal:

1. Connect a directional antenna to the YBT250 input.
2. Select the Interference display (.
3. Select the **Strength** tab.
4. Adjust the span and Measurement Frequency to the area of concern.
5. Set the Measurement Frequency to a signal of interest on the trace.
6. To locate an interfering signal, point the directional antenna in different directions.

As you change the direction of the antenna, you will hear a change in the audible tone and beep (if switched on) and see a change in the Strength bar. The source of the signal is located in the direction that results in the highest signal strength.

Demodulating an Interfering Signal

Requires Option IN1, Interference Analyst

One method to identify an interfering signal is to demodulate the signal. This enables you to listen for any identifying information, such as a station ID, in the signal. A station ID can be particularly helpful when the interfering signal is a radio or broadcast television station. You may also be able to discriminate between possible sources by listening to the characteristic sounds of paging, video, control signals or the harmonics of other common signals. The Audio Demodulation display and controls are shown in Figure 3-23.

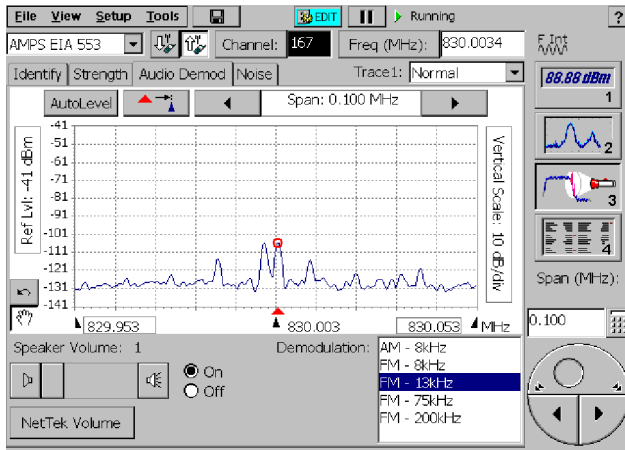



Figure 3-23: Example of an Audio Demod display

To demodulate the audio of an interfering signal:

1. Select the Interference display () .
2. Select the **Audio Demod** tab.
3. Display the trace of the interfering signal.
4. Tap the trace at the peak of the suspected interfering signal to set the measurement frequency.
5. Select a demodulation type and bandwidth from the **Demodulation** box on the lower-right of the results area. The YBT250 will play the demodulated signal through the speaker. While the audio plays, the trace display is frozen briefly.

NOTE. To conserve power, the YBT250 will not demodulate a signal continuously, even if plugged into an external power source. The demodulation will cycle on and off. It will be on for four seconds, off for one second and then repeats the cycle.

- If the audio doesn't sound right, select another demodulation type or bandwidth.

Measuring the Noise Floor

Requires Option IN1, Interference Analyst

Noise Floor measures all the RF Power coming into the receive antenna within the frequency band of the selected channel. The Noise Floor is the power integrated across the selected channel. To make an accurate measurement, the Noise Floor must be measured on a disabled channel (that is, a channel that is not carrying live traffic). Larger numbers indicate more noise. Figure 3-24 shows an example of a Noise Floor measurement.

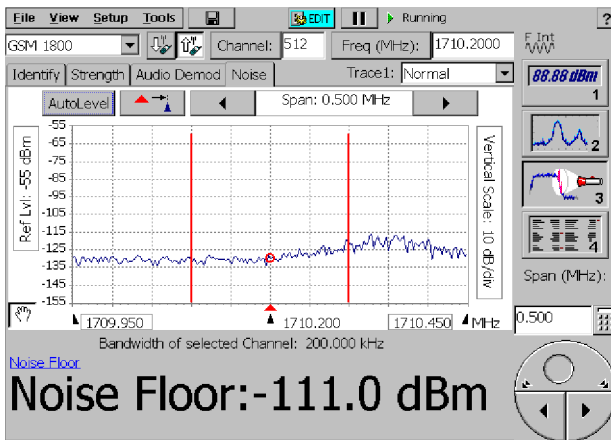



Figure 3-24: Example of a Noise Floor measurement

To measure the noise floor:

1. Connect a signal (see page 2-23) from a receiver test port to the YBT250 RF INPUT connector.
2. If there is no test port:
 - a. Disconnect the receiver cable from the transmitter.
 - b. Connect the receiver cable to the RF INPUT connector.
3. Select the Interference display ()
4. Select the **Noise** tab.
5. Select the Signal Standard.
6. Select the Channel.
7. Select Reverse Link ()

The Noise Floor measurement is displayed below the trace display. Noise Floor is displayed in dBm, with a resolution of 0.1 dB. The two vertical lines in the trace display indicate the upper and lower frequencies of the channel being measured.

Locating Intermittent Interference

Requires Option IN1, Interference Analyst

Intermittent interference can be difficult to identify. The YBT250 Spectrogram display is ideal for spotting intermittent interference. A spectrogram displays how a signal changes over time, in addition to frequency and level. Because the spectrogram displays signals over a period of time, signals that are intermittent are easy to spot. See Figure 3-25.

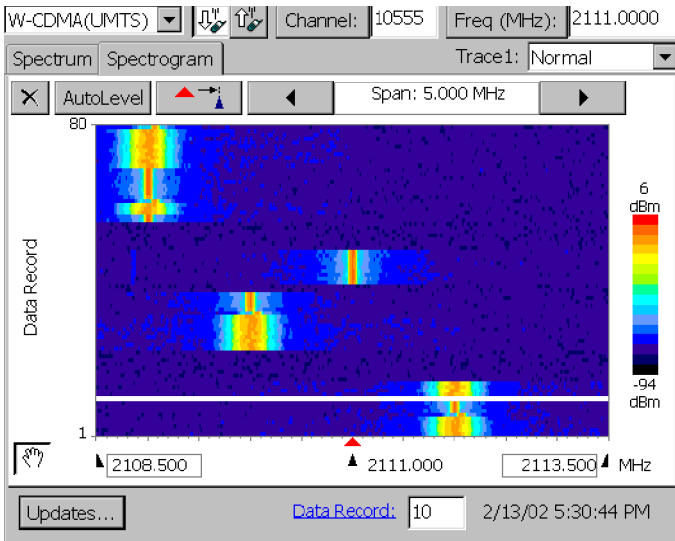



Figure 3-25: A Spectrogram display of an intermittent signal

To locate an intermittent interference signal:

1. Connect the YBT250 RF INPUT to the signal. The signal may be from an antenna for off-the-air signals or you may need to connect to a test point on the base station.
2. Select the Spectrum display ()
3. Set the Measurement Frequency and span to show the frequency range of concern.
4. Set the Vertical Scale (dB/div) so that the trace nearly fills the vertical range of the graph area.
5. Select the **Spectrogram** tab.
6. To locate an intermittent signal, sweep the antenna along the horizon and then vertically, while looking for bursts matching the interfering signal on the spectrogram.

Time in the spectrogram display runs from the bottom to the top, with the most recent data at the bottom of the display. Continuous signals display an uninterrupted vertical line (although the signal level can vary). Intermittent signals will show up as a discontinuous vertical line. Signals of varying frequency will appear as a slanted or crooked line through the display.

To determine the date and time when an intermittent signal occurred:

1. Locate the Data Record cursor at a discontinuous point on the vertical line located at a frequency of interest.
 - a. Tap the Data Record box to assign the knob to the Data Record.
 - b. Use the knob to change the position of the data record cursor (the cursor value can vary from 1 to 80). Each record will display the date and time it was recorded to the right of the Data Record box.
2. The date and time indicates when the selected data record was acquired.

To achieve the best spectrogram display:

- Tap the Restart icon () to clear the trace history and restart collecting data.
- Select **Updates...** to change how often the spectrogram is updated.
- Ensure the Trace Interval is long enough when the trace type is set to Average. If the Trace Interval is too short, you will not see the effect of averaging when a spectrogram is displayed. The spectrogram update rate (set by Trace Interval) must allow time for the averaging function to produce an averaged spectrum. For example, if the YBT250 requires 10 seconds to average the trace, a Trace Interval shorter than 10 seconds will not show the effect of averaging.

- For the best spectrogram display, first adjust the Spectrum graph as follows: decrease the dB/div setting and move the graph up or down (by adjusting the reference level or vertical scroll bars when present) until the trace covers at least eight vertical divisions.

Analyzing W-CDMA Scrambling Codes



Requires Option WS1, W-CDMA Scrambling Code Analyzer

The W-CDMA Scrambling Code Analyzer (SCA) detects the scrambling code and pilot power level of each received W-CDMA downlink signal when multiple signals are present. The SCA is intended for off-air reception using an antenna, and measures only downlink signals.

The maximum number of signals that can be detected is ten.

To make accurate measurements of the downlink signals, you should use a receive antenna with frequency response and bandwidth appropriate for the channel you want to measure. You should also use a high quality, low-loss Band Pass Filter (BPF) to reject signals outside the signal band. If you take measurements near a high power transmitter such as commercial TV or radio, the BPF may be necessary to allow the SCA to produce useable results.

To use the Scrambling Code Analyzer:

1. Connect the antenna and filter (if used) to the RF input using high quality cabling.
2. Select the Interference display ().
3. Select the **Scr Code** tab.
4. Select the Signal Standard.
5. Select the Channel.
6. Select Forward Link (.
7. If you know the attenuation of the antenna, filter, and connecting cable, you may account for it. Select the **Edit** button > **Input** tab and enter the value in the **Attenuator Loss** field.

W-CDMA Scrambling Code Results

I_o is the received power in the W-CDMA signal bandwidth, in dBm. (I_o is also known as N_o or RSSI.)

Scrambling Code is the Primary Scrambling Code number of each detected downlink signal.

E_c/I_o is the energy per chip in a downlink pilot channel code, normalized to the received power, in dB. Essentially, it is the ratio of the power of each detected pilot channel code to the total received power. An E_c/I_o value of -10 dB indicates that pilot code contributes one tenth of the total received power.

E_c is the absolute power level of each detected pilot channel code, in dBm. (E_c is also known as RSCP.)

In the graph, look for only one or two signals to have high E_c/I_o (>-10 dB). Any other detected signals should have E_c/I_o of 5 to 10 dB less than these to avoid interference. If there are three or more signals of high and approximately equal level, one or more of the transmitters may need adjustment to prevent excessive interference in that location.

Results are normally displayed in descending order of E_c/I_o level in both the graph and table. As E_c/I_o varies, codes may change order or disappear from the result.

Sorting or Locking the Current Set of Scrambling Codes

You can either sort or lock the current set of scrambling codes.

To sort the results, select one of the following choices:

- **Power (E_c)** to sort by descending E_c level. (See Figure 3-26.)
- **Scrambling Code (SC)** to sort by ascending Sc_r Code index.

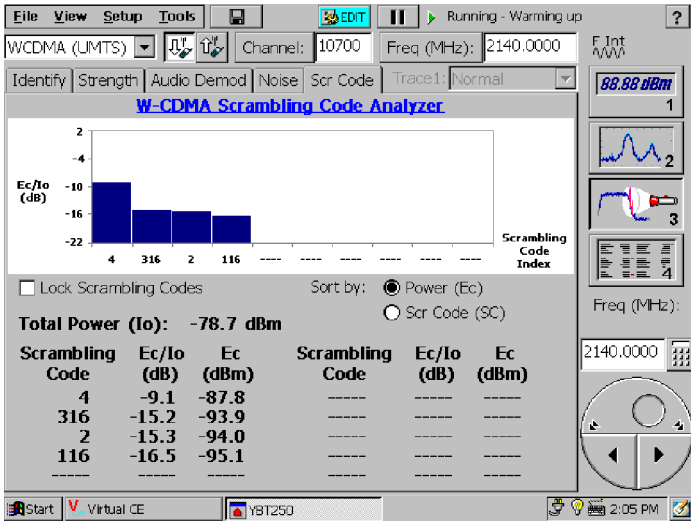

Figure 3-26: Scrambling codes sorted by descending power (Ec)

Alternatively, to lock and hold the current set of detected Scrambling Codes, select **Lock Scrambling Codes**. Select Lock a second time to remove the hold action. See Figure 3-27 for a screen capture of locked scrambling codes.

NOTE. When Lock is enabled, if a new signal is detected, the YBT250 will not display the new signal until Lock is disabled.

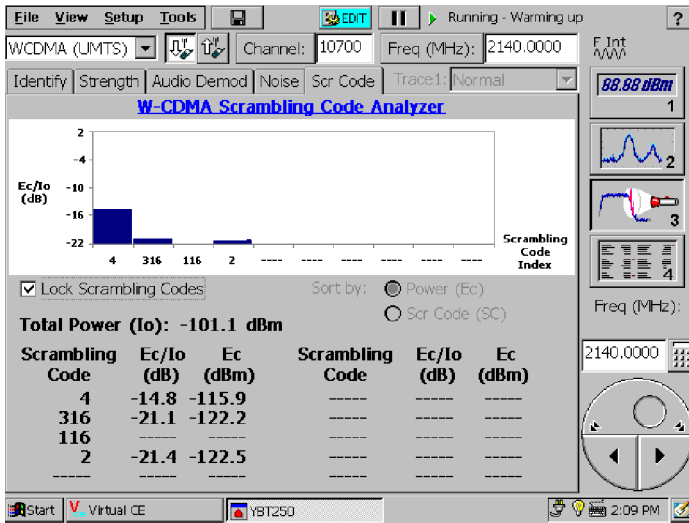

Figure 3-27: Locked scrambling codes

Taking Measurements

The YBT250 provides measurement capabilities to quickly and easily determine the condition of a transmitter. Measurements are available to measure power, spectral response and modulation.

The Measure Window Display

The Measure window display is where readouts for the selected measurement appear. Figure 3-28 shows a typical Measure display.

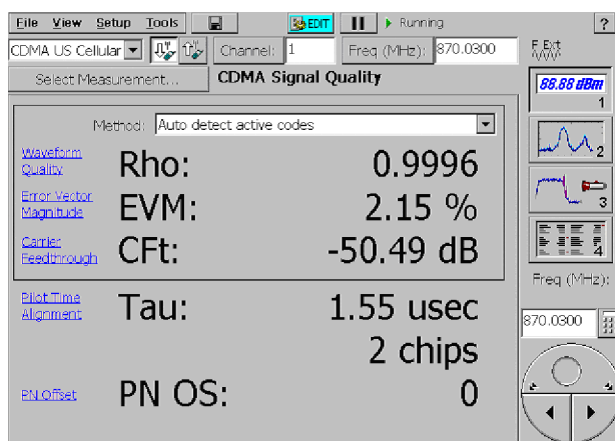







Figure 3-28: A Measure window display

Table 3-6 lists the buttons and icons that can appear in the Measure window display and it explains what each button or icon represents.

Table 3-6: Measure window buttons and icons

| Button | Function |
|---|--|
|  | This button appears in the Channel Power measurement. It sets the horizontal range to one channel width plus half a channel on either side |
|  | This button appears in the Channel Power measurement. It sets the horizontal range to just over five channels. |
|  | This button appears in the Channel Power measurement. It sets the horizontal range to 10 MHz or 10 channel widths, whichever is greater. |
|  | This arrow is a Fail indicator. It appears when a measurement exceeds the upper limit. |
|  | This arrow is a Fail indicator. It appears when a measurement falls below the lower limit. |

Setting the Measurement Frequency

Measurements are made at a specific frequency. The frequency at which measurements are made is called the Measurement Frequency. Before making a measurement, you must ensure the Measurement Frequency is properly set.

The measurement frequency is indicated on the spectrum display two ways. One indicator is the **Freq (MHz)** readout. For example, in Figure 3-29 the Freq (MHz) readout shows a measurement frequency of 878.4900 MHz. The second measurement frequency indicator is the small triangle and circle that appears on the trace display.

Note that the Measurement Frequency can be located anywhere in the spectrum display; it does not have to be located at the center.

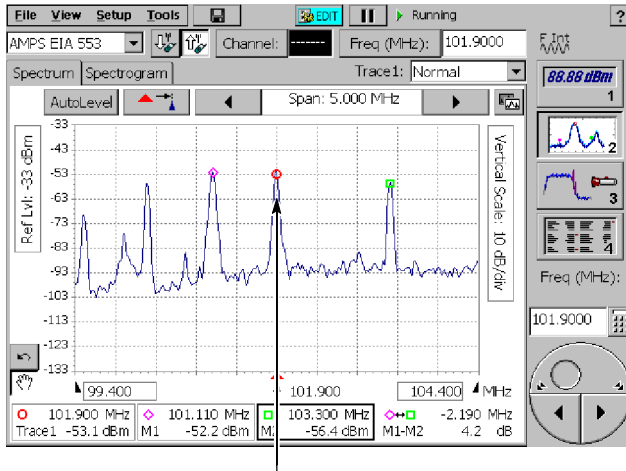

Measurement Frequency Indicator

Figure 3-29: Measurement Frequency indicator

There are four ways to set the measurement frequency:

- Tap the trace
- Select a channel number
- Enter the measurement frequency with the numeric keypad
- Use the knob

To set the measurement frequency by tapping the display:

1. If Markers are displayed, tap the Measurement Frequency Marker box (labeled as Trace 1/2).
2. Tap the trace at the point where you wish to make a measurement.

- To increase the precision of where the frequency is set, tap the decrease span button () to change the horizontal scale of the display.

To set the measurement frequency using the numeric keypad:

1. Tap the **Freq (MHz)** button. This displays the input keypad. See Figure 3-30.



Figure 3-30: Entering the measurement frequency with the keypad

2. Enter the specific frequency at which you want to make measurements by tapping the keypad.

You enter a frequency by tapping a number followed by a multiplier. You must include the multiplier (GHz, MHz, kHz, or Hz) to complete your input.

- For example, to enter a frequency of 370 MHz, tap 3 7 0 MHz.

- To enter a frequency of 370.330 MHz, tap 3 7 0 . 3 3 0 MHz.

To correct a mistyped number, tap the backspace button. If you enter a number that is outside the frequency range of the instrument, the measurement frequency is set to the maximum or minimum, depending on the value you entered.

To set the measurement frequency using the knob:

1. Tap the box displaying the measurement frequency (*not* the Freq (MHz) button). This assigns the knob to the measurement frequency. The label above the knob display will change to **Freq (MHz)**.
2. Tap the knob to change the measurement frequency.
 - Tap the top half of the knob to make large changes to the measurement frequency. Tapping the knob to the right of the circle increases the frequency. Tapping the knob to the left of the circle decreases the frequency.
 - Tapping the arrow buttons on the lower half of the knob makes smaller changes than tapping the top half.

What Measurements are Available

The measurements available depend on the selected signal standard and which options are installed. Some measurements, such as cdmaOne Code Domain Power, are not available for all standards. All measurements require options to be installed. The option required depends on the type of measurement and signal standard. For information on the available measurement options, see Appendix C.

Limit Testing

The YBT250 can be set to display indicators or perform an action when a measurement exceeds specified limits. The following paragraphs list the measurements for which limit tests are available.

Analog Limit Test Measurements

- RF Channel Power
- RF Channel Power Difference vs. Reference Power
- Frequency Error (in kHz and ppm)
- Occupied Bandwidth
- FM Deviation

cdmaOne/cdma2000 Limit Test Measurements

- RF Channel Power
- RF Channel Power Difference vs. Reference Power
- Peak/Average Power
- Pilot Power
- Pilot Difference
- Frequency Error (in kHz and ppm)
- Occupied Bandwidth
- PN Offset
- Rho (Waveform Quality)
- Tau
- EVM (Error Vector Magnitude)
- Carrier Feedthrough
- Code Power

GSM Limit Test Measurements

- RF Burst Power
- Frequency Error (in kHz or ppm)
- Occupied Bandwidth

GSM/EDGE Limit Test Measurements

- RF Channel Power (absolute or relative)
- Carrier to Interference (C/I)
- Error vector magnitude (EVM)
- Frequency Error (in kHz or ppm)
- Occupied Bandwidth
- Origin offset
- Phase error

NADC IS-136 Limit Test Measurements

- RF Channel Power
- RF Channel Power Difference vs. Reference Power
- Peak/Average Power
- Frequency Error (in kHz and ppm)
- Occupied Bandwidth

W-CDMA Limit Test Measurements

- RF Channel Power
- RF Channel Power Difference
- Peak/Average Power
- Frequency Error (in kHz and ppm)
- EVM (Error Vector Magnitude)
- Carrier Feedthrough
- Occupied Bandwidth
- OVSF Code Power

- P-CPICH Power
- ACLR Lower 1 and Lower 2
- ACLR Upper 1 and Upper 2

cdma2k 1xEV-DO Limit Test Measurements

- Pilot/MAC Power
- Non-idle Total Power
- Non-idle Data Power
- Idle Data Power
- Non-idle Transmission Envelope Mask Test
- Idle Transmission Envelope Mask Test
- Frequency Error (in kHz and ppm)
- PN Offset
- Rho (Pilot)
- Rho (Overall-1)
- EVM (Pilot)
- EVM (Overall-1)
- Pilot Time Alignment
- Occupied Bandwidth
- Data Code Power (minimum)
- Data Code Power (maximum)

Enabling Limit Testing

To enable limit testing:

1. Tap the **Edit** button at the top of the display. This displays the Setup window.
2. Tap the **Limits** tab. See Figure 3-31.

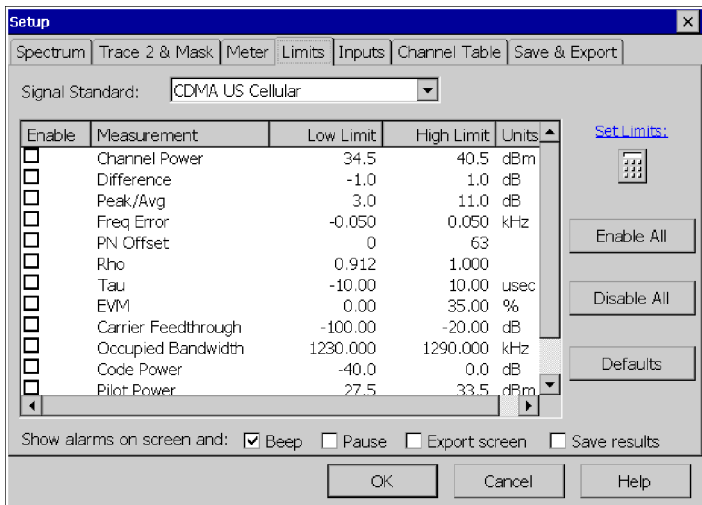

Figure 3-31: Enabling limit testing

3. Select the signal standard from the list at the top of the window.
4. Tap the appropriate box in the **Enable** column at the left side of the window to enable or disable a limit test.
 - a. To enable limit testing for a specific measurement, tap the box in the **Enable** column so that an **X** appears in the box.
 - b. To disable limit testing for a specific measurement, tap the box so that there is no **X** in the box.

- c. To enable limit testing for all the measurements, tap the **Enable All** button.
 - d. To disable limit testing for all the measurements, tap the **Disable All** button.
- 5. To change the limits for a measurement:
 - a. Tap the limit you want to change. This highlights the limit value of the measurement.
 - b. Tap the numeric keypad to enter a new value for the limit. Tap **OK** to complete the change.
 - c. You can disable either the Low Limit or High Limit test for a measurement by clearing the contents of the cell. Disabling one test limit does not disable the other test limit.

For example, suppose you wish to test the High Limit for RF Power, but are not interested in testing the Low Limit. To enable testing for the High Limit, you must enable the limit test for RF Power. To disable the Low Limit test for RF Power, tap the Low Limit cell for RF Power and clear the contents of the cell (using the backspace key on the numeric keypad).
 - d. To reset the limits for all measurements to factory default values, tap **Defaults**.
- 6. To specify what the YBT250 should do when a limit is exceeded:
 - a. Tap the check box for **Beep** to cause the YBT250 to make a beep sound when a limit is exceeded.
 - b. Tap the check box for **Pause** to cause the YBT250 to pause and display a message box when a limit is exceeded.

- c. Tap the check box for **Export Screen** to cause the YBT250 to export the screen display when a limit is exceeded. (The name for the exported screen will be automatically generated.)
 - d. Tap the check box for **Save Results** to cause the YBT250 to save the measurement results to a file when a limit is exceeded. The name for the saved file is automatically generated when the file is created.
7. When you are finished setting up the measurement limits, tap **OK**.

NOTE. *The YBT250 automatically optimizes the reference level, span and bandwidth filters to provide the most accurate results when making measurements.*

Setting the Scrambling Code Detection

Requires Option WD1, Demodulation for W-CDMA

The YBT250 enables you to specify how it detects the scrambling code of a W-CDMA signal for demodulated measurements. There are two settings for the scrambling code control: Auto and Manual. The default setting is Auto.

- In **Auto** mode, the YBT250 automatically detects the scrambling code by using the P-SCH and S-SCH codes to determine the code group, then searches only for the scrambling codes within that code group. If multiple signals are present, the scrambling code of the signal with the highest power P-SCH and S-SCH will be detected.
- In **Manual** mode, the YBT250 bypasses the SCH codes and searches only for the signal with the specified scrambling code.

The Manual setting is primarily used in off-air testing in areas where there are multiple transmitters and there is a need to make measurements on a specific transmitter.

NOTE. If you receive an error message stating CDMA Sync Not Found, check that the Scrambling Code setting is properly set. If it is set to Manual and the code is set wrong, the YBT250 will indicate that it cannot find a signal. This is because it is looking only for a signal with the specified scrambling code. Signals with different scrambling codes are ignored. This error message can occur with the following measurements: Carrier Frequency, Signal Quality, Code Power, Codogram, and Pilot Power.

Changing the Setting

To change the scrambling code setting:

1. Select the **W-CDMA** Signal Standard.
2. Tap the **Edit** button to display the Setup window.
3. Tap the **Meter** tab. See Figure 3-32.

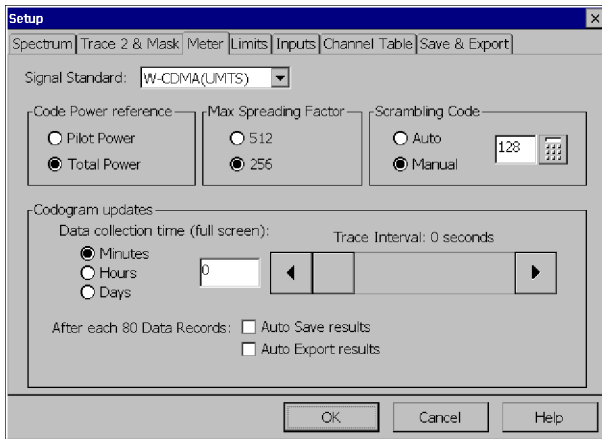

Figure 3-32: Setting the scrambling code

4. Tap **Auto** or **Manual** to change the setting.

5. To set the scrambling code in Manual mode, tap the numeric keypad and enter the scrambling code for the transmitter on which you wish to make measurements. The acceptable range for codes is 0-511.
6. Tap **OK** to accept the setting change.

How the Scrambling Code Setting is Indicated in Displays

The way the scrambling code is displayed changes depending on the scrambling code setting. When the scrambling code setting is Auto, the words **Scrambling Code** are used in the display. When the scrambling code setting is Manual, the words **Scr Code (Manual)** are used in the display.

Measuring RF Power

Requires a Measurement Option

RF Power can be measured by itself and/or compared to a specified Reference Channel.

To measure RF Power:

1. Connect a signal to the YBT250 RF INPUT connector. See page 2-24 for connection instructions.
2. Select the Measure window (button 1).
3. Tap **Select Measurement**. This displays the Select Signal Standard and Measurement dialog box.
4. Select the Signal Standard.
5. Tap **RF Power**. See Figure 3-33.

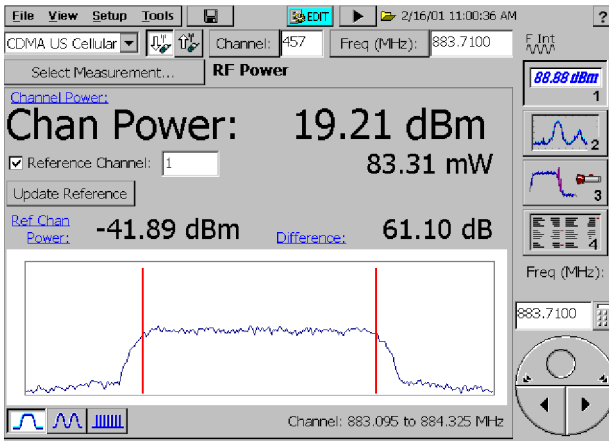





Figure 3-33: RF Power measurement for CDMA

6. Select Forward Link ().
7. Select the Channel:
 - a. Tap the Channel box. This assigns the knob and numeric keypad to Channel.
 - b. Tap the numeric keypad to enter the channel number directly or use the knob to change the channel number.

The vertical bars in the display represent the upper and lower frequency limits of the specified channel. You can change horizontal range (span) of the display by selecting one of the three buttons in the lower-left corner of the display:

- Select  to change the horizontal range to one channel width plus half a channel or either side.
- Select  to change the horizontal range to just over five channels.
- Select  to set the horizontal range to 10 MHz or 10 channel widths, whichever is greater.

To compare the power level against another channel (only for non-bursted signal types), such as a reference channel:

1. Tap the Reference Channel box.
 - Use the numeric keypad or the knob to set the Reference Channel number.
2. Tap the Update Reference button any time you want to remeasure the Reference Channel's power.

NOTE. *Ref Chan Power is the power of the Reference Channel measured when you tap the Update Reference button. The reference power is the power at the forward frequency of the reference channel (unless you are using W-CDMA, in which case it is the power at the reference channel).*

Difference is the measured difference in power between the selected channel and the reference channel.

When GSM is the selected signal standard for RF Channel Power measurements, the YBT250 attempts to locate and measure an RF power burst during the active burst. If no burst is found, the measurement defaults to a continuous power measurement on the selected channel, and displays a dialog stating that no RF burst was found.

Measuring GSM/EDGE RF Power

Requires RF Measurement Option EM1

The GSM/EDGE RF Power measurement measures the average RF power transmitted during the useful part of a GSM timeslot.

The measurement can, at your option, use a specified BCCH channel to acquire timeslot frame sync, enabling identification and measurement of individual GSM frame timeslots (0-7).

You can measure and display each RF timeslot power independent of other levels. If BCCH frame sync is available, you can also display the RF power as a difference value, relative to the BCCH Slot 0 power level.

To measure GSM/EDGE RF Channel Power:

1. Connect a signal to the YBT250 RF INPUT connector. See page 2-24 for connection instructions.
2. Select the Measure window (button 1).
3. Tap **Select Measurement**. This displays the Select Signal Standard and Measurement dialog box.
4. Select GSM/EDGE Signal Standard.
5. Tap **RF Power**. See Figure 3-34.

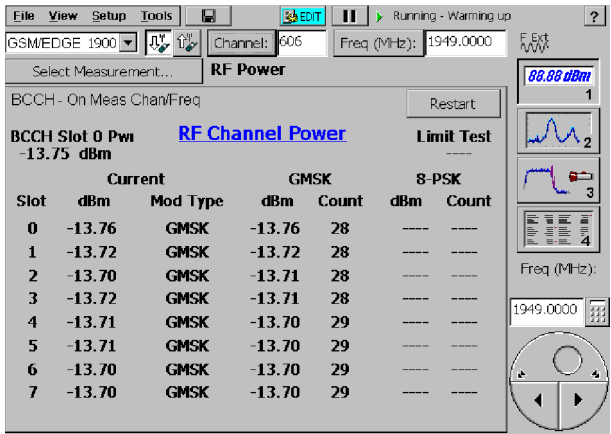



Figure 3-34: GSM/EDGE RF Power measurement

6. Select Forward Link ().

7. Tap the Channel box and enter a valid channel number for the current standard.

The GSM/EDGE RF Power screen displays the following:

- The BCCH slot 0 signal source. Valid signal sources are None, On Meas Chan/Freq, On Channel xxx, and On Freq xx.xxx, where xxx and xx.xxx are the numeric values for a channel or frequency, respectively.
- The BCCH slot 0 average power value. The BCCH slot 0 power measurement value is always in dBm (absolute).

NOTE. *The BCCH Slot 0 Power value is displayed only if the BCCH Frame Sync control is not set to OFF, a valid BCCH channel is present, and frame sync is acquired.*

- A Restart button that clears all multi-slot averaged measurement and count values and then restarts the averaging process.
- A Limit Test indicator that shows whether any measurements are outside the defined limit test values. See page 3-59 for information on enabling limit testing.
- The current power value and modulation type for each slot.
- The average power reading and number of acquisitions averaged (count) for GMSK signals for each slot. See page 3-70 for information on setting the number of acquisitions to average.
- The average power reading and number of acquisitions averaged (count) for 8-PSK signals for each slot. See page 3-70 for information on setting the number of acquisitions to average.

Setting GSM/EDGE BCCH Frame Sync Modes

To set the GSM/EDGE RF Channel Power BCCH Frame Sync mode:

1. Tap the **Edit** button at the top of the display. This displays the Setup window.
2. Tap the **Meter** tab. See Figure 3-35.

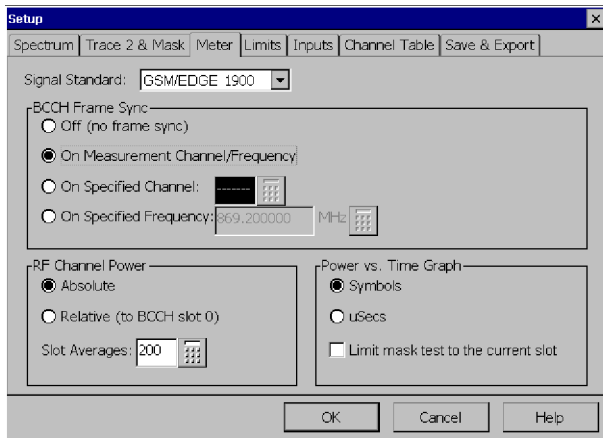

Figure 3-35: GSM/EDGE RF Power measurement parameters

3. Select a GSM/EDGE signal standard from the list at the top of the window.
4. Select a BCCH Frame Sync mode:
 - Off (no frame sync): Turns off BCCH frame sync, causing the YBT250 to attempt to acquire slot sync by using the power envelope ramps (edges) of the received signal. The YBT250 then measures one randomly-chosen slot. Figure 3-36 shows a typical RF Power measurement with BCCH set to Off.

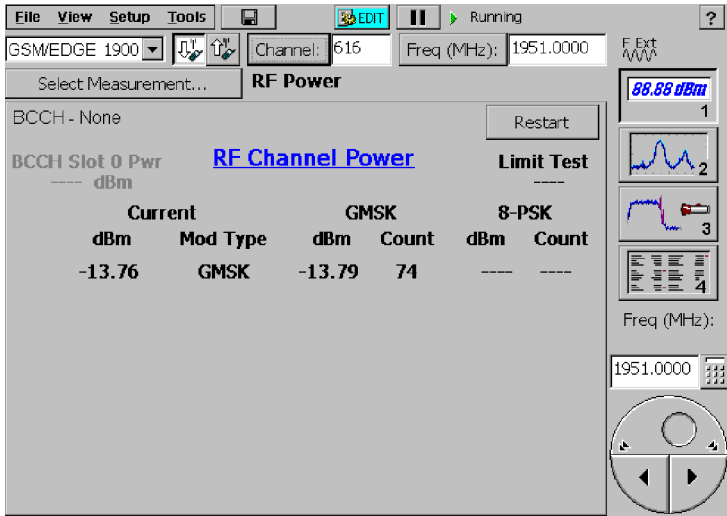

Figure 3-36: GSM/EDGE RF Power with BCCH turned off

- On Measurement Channel/Frequency: Sets the YBT250 to frame sync on slot 0 of the currently measured channel/frequency, which is displayed in the Channel and Freq (MHz) fields at the top of the measurement display.
 - On Specified Channel: Sets the YBT250 to frame sync on slot 0 of the specified channel. Tap the keypad icon to enter a channel number.
 - On Specified Frequency: Sets the YBT250 to frame sync on slot 0 of the specified frequency. Tap the keypad icon to enter a frequency value.
5. Tap **OK** to accept the selections, close the Setup window, and return to the RF Power display. Tap **Cancel** to close the Setup window without taking any action.

When any of the BCCH Frame Sync **On** modes are selected, the YBT250 attempts to detect the FCCH and SCH bursts on the specified Frame Sync channel. If it detects the bursts, the YBT250

establishes frame timing and can then measure any of the slots (0..7) within the frame. If the YBT250 does not detect the sync bursts, it attempts to find slot timing by using the power envelope ramp edges of the signal on the measurement frequency or channel.

Channel and Frequency Setting Interactions

When you enter a value in the On Specified Channel field, the value in On Specified Frequency updates to reflect the frequency associated with the channel number for the current measurement standard.

When you enter a value in the On Specified Frequency field, the value in the On Specified Channel field also updates as follows:

- If the specified frequency has an associated channel number for the current measurement standard, then the On Specified Channel field displays the channel number.
- If the specified frequency is within the range of a channel of the current measurement standard, but does not align exactly with a channel number, then the On Specified Channel field displays the nearest channel number in reverse video (white/gray text on a black background).
- If the specified frequency is outside the range of a channel of the current measurement standard, then the On Specified Channel field displays dashes in reverse video (white/gray text on a black background).
- When On Specified Channel is selected, changing to a different GSM measurement standard can cause the channel number to change to a valid channel number in the new standard. The On Specified Frequency value also changes to display the frequency for the new channel and standard.

Setting GSM/EDGE RF Channel Power Modes

To set the GSM/EDGE RF Channel Power mode:

1. Tap the **Edit** button at the top of the display. This displays the Setup window.
2. Tap the **Meter** tab. See Figure 3-35.

3. Select a GSM/EDGE signal standard from the list at the top of the window.
4. Select an RF Channel Power mode:
 - Absolute: displays all slot power measurement values as absolute. Measurement values are displayed in dBm units. Figure 3-37 shows a typical RF Power measurement with RF Channel Power set to Absolute.

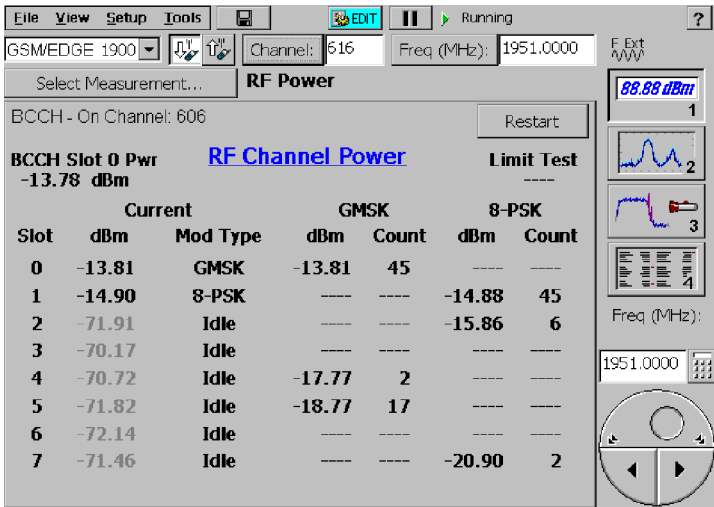

Figure 3-37: GSM/EDGE Absolute RF Power measurement

- Relative (to BCCH slot 0): displays all slot power measurement values relative to the BCCH Slot 0 power measurement. Measurement values are displayed in dB units. Figure 3-38 shows a typical RF Power measurement with RF Channel Power set to Relative.

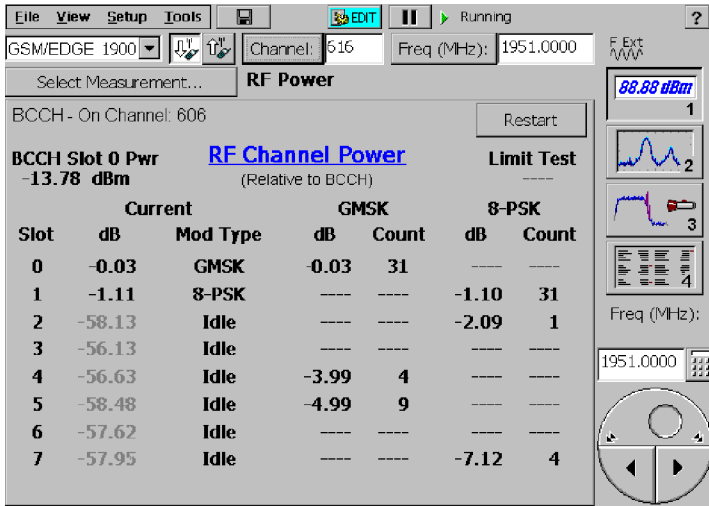

Figure 3-38: GSM/EDGE Relative RF Power measurement

- Slot Averages: Sets the number of acquisitions over which to average slot power measurements. Tap the keypad icon to enter a value from 1 to 200 (the default is 200).
5. Tap **OK** to accept the selections, close the Setup window, and return to the RF Power display. Tap **Cancel** to close the Setup window without taking any action.

Measuring cdma2000 1xEV-DO RF Power

Requires CRE Measurement Option

You can measure the RF Power of a 1xEV-DO signal within a selected forward channel. A basestation using 1xEV-DO signals can transmit at idle and non-idle power levels depending on the use of the individual slots for carrying data at that time. The YBT250 distinguishes between idle and non-idle slots and performs power measurements on each type of slot.

Look at the graph to see whether the waveform power remains within the green lines of the mask. Look at the readouts to see the average power.

To measure RF Power:

1. Connect a signal to the YBT250 RF INPUT connector. See page 2-24 for connection instructions.
2. Select the Measure window (button 1).
3. Tap **Select Measurement**. This displays the Select Signal Standard and Measurement dialog box.
4. Select a **1xEV-DO** standard.
5. Tap **RF Power**. See Figure 3-33.
6. Select Forward Link ().
7. Tap the Channel box and enter a valid channel number for the current standard.
8. Tap the **Idle** or **Non-Idle** button.

Refer to Figure 3-39.

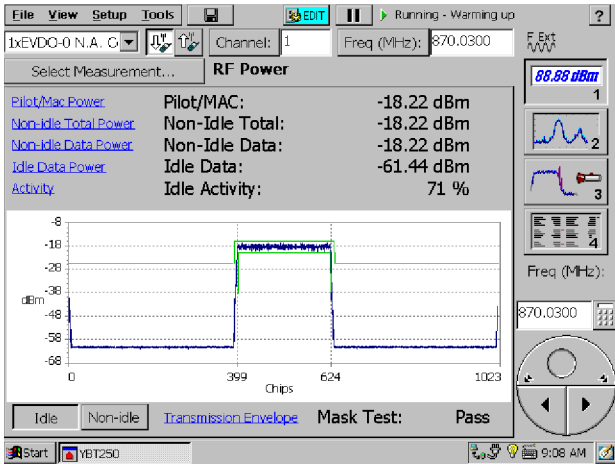

Figure 3-39: RF Power measurement for 1xEV-DO

Refer to Table 3-7 for explanations of the readouts on screen.

Table 3-7: RF Power screen result values

| Result name | Waveform interval included in result |
|-----------------|---|
| Pilot/MAC Power | Average power of Pilot/MAC intervals of all half-slots |
| Non-Idle Total | Average power of entire half-slot of non-idle half-slots |
| Non-Idle Data | Average power of data intervals of non-idle half-slots |
| Idle Data | Average power of data intervals of idle half-slots |
| Activity | Percentage of acquired half-slots which are of the selected type (idle or non-idle) |

1xEV-DO Transmission Envelopes on the RF Power Screen

The YBT250 draws a waveform representing the averages of either the idle (not transmitting power in data interval) slots or the non-idle (transmitting power in data interval) slots. The averaging smooths

out the more extreme bumps in the waveforms. Idle slots and non-idle slots are averaged separately.

The horizontal axis of the graph is in chips, and the first and last chip of each data interval is marked.

If the waveform strays outside the green lines of the mask, the mask test result will display Fail, and the section(s) of the mask where the failure occurred will turn from green to red. There are mask sections for each data interval, each mac interval, and for the pilot interval.

You can enable or disable the Mask test by tapping View > Mask. To set alarm actions (such as beeping), select **Setup > Edit > Limits**.

Mask for Idle Slots. Select the **Idle** button. In the graph area, you will see a time-domain mask represented by green lines within which you want to see a square waveform representing the Pilot/MAC signal. If the waveform strays outside the mask, the Mask Test results will display Fail.

Mask for Non-Idle Slots. Select the **Non-idle** button. In the graph area, you will see a time-domain mask represented by green lines within which you want to see a long, relatively flat waveform representing the data-interval part of the signal. If the waveform strays outside the mask, the Mask Test results will say Fail.

Troubleshooting. A test may take a long time to run if the basestation is not currently transmitting very many of the type of slot you are trying to measure.

The YBT250 will try to collect 100 half slots of the selected slot type (idle or non-idle) before giving a result. If the YBT250 cannot collect 100 half-slots of the selected type to make the measurement after collecting 1000 total half-slots, it will display the average waveform for as many half-slots as it could collect, and it will report “* Waveform not fully averaged *”. If no half-slots of the requested type could be collected during the attempt, it will display “* No non-idle(idle) half slots found *”.

To speed up the measurement rate, switch to the other slot type by pressing the appropriate button (Idle or Non-Idle) at the bottom of the screen. This will increase the measurement update rate, and the numeric power results will still be valid.

Measuring GSM/EDGE Power vs. Time

Requires RF Measurement Option EM1

The Power vs. Time measurement (GSM/EDGE signals) compares the RF power burst envelope for the specified slot against a mask defined by the selected signal standard and measured modulation type. The comparison determines whether the burst envelope power and timing constraints are within the mask constraints for that slot and modulation type. This test verifies that the transmitter ramps up, maintains RF power, and turns off completely within the time envelope defined for the standard and modulation type.

To measure GSM/EDGE Power vs. Time:

1. Connect a signal to the YBT250 RF INPUT connector. See page 2-24 for connection instructions.
2. Select the Measure window (button 1).
3. Tap **Select Measurement**. This displays the Select Signal Standard and Measurement dialog box.
4. Select a GSM/EDGE Signal Standard.
5. Tap **Power vs. Time**. See Figure 3-40.
6. Select Forward Link ().
7. Tap the Channel or Frequency box and enter a valid channel or frequency value.
8. Tap the Slot field keypad icon and enter a slot number to measure.

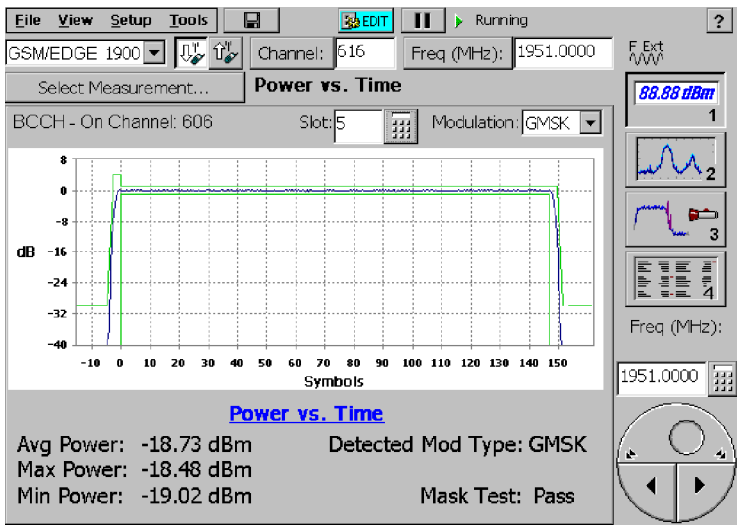

Figure 3-40: GSM/EDGE Power vs. Time measurement

9. Tap the Modulation field to select the modulation type to detect.

The GSM/EDGE Power vs. Time screen displays the following:

- The BCCH slot 0 signal source. Valid signal sources are None, On Meas Chan/Freq, On Channel xxx, and On Freq xx.xxx, where xxx and xx.xxx are the numeric values for a channel or frequency, respectively. See page 3-67 for information on setting the BCCH signal source (frame sync mode).
- A graph that shows the specified slot signal and the mask limits against which the signal is compared. The graph vertical units are the measured slot power, in dB, relative to the computed average power. The graph horizontal units can be either symbols or time. See page 3-79 for information on setting the graph units.

The mask used for testing is determined by the GSM/EDGE standard and the detected modulation type.

- The Avg Power, Max Power, and Min Power fields, which display the slot average, maximum, and minimum power values, in dBm. The Avg, Max and Min power values are computed only for the useful part of the burst.
- The Detected Mod Type field, which lists the actual measured signal modulation type. The YBT250 first searches for a valid signal for the modulation type selected in the Modulation list. If that modulation type is not detected, the YBT250 then searches for the other modulation type. If neither modulation type is detected, this field shows dashes (----).
- The Mask Test field, which indicates the pass or fail status of the mask test. The mask used for testing is based on the GSM standard and the detected modulation type. Figure 3-41 shows a failed Power vs. Time mask test.

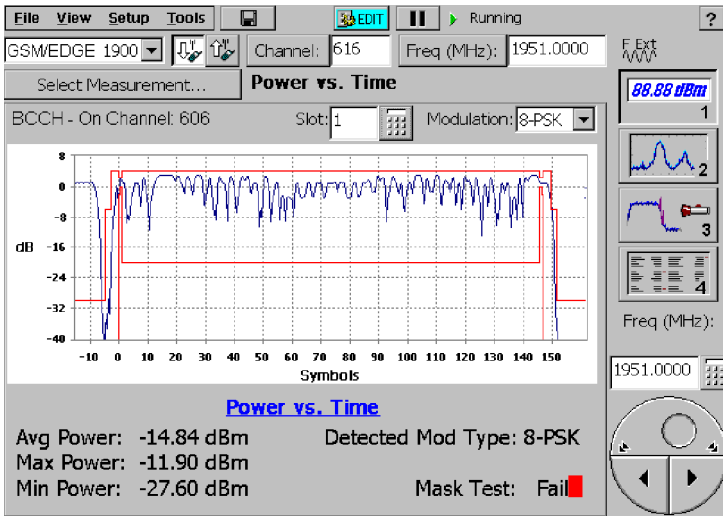

Figure 3-41: GSM/EDGE Power vs. Time mask fail example

NOTE. *To search for the modulation type in all slots, instead of only the specified slot, set the BCCH Frame Sync control to Off.*

Setting GSM/EDGE Power vs. Time parameters

To set the GSM/EDGE Power vs. Time graph horizontal units:

1. Tap the **Edit** button at the top of the display. This displays the Setup window.
2. Tap the **Meter** tab. See Figure 3-35.
3. Select a GSM signal standard from the list at the top of the window.
4. Select the Power vs. Time Graph parameters:
 - **Symbols:** Sets the graph horizontal units to symbols.
 - **µSecs:** Sets the graph horizontal units to microsecond time units.
 - **Limit mask test to the current slot:** Enables use of a truncated version of the mask (the horizontal portions are omitted from the beginning and ending of the mask) to allow signals that contain active slots adjacent to the slot being tested to pass the mask test. The default value is not enabled (not checked), which corresponds to using the complete mask as defined by the current standard and modulation type.
5. Tap **OK** to accept the selections, close the Setup window, and return to the Power vs. Time display. Tap **Cancel** to close the Setup window without taking any action.

Measuring Peak to Average Power Ratio

Requires an RF Measurement Option

The YBT250 enables you to check transmitter headroom by measuring the Peak to Average Power Ratio.

To measure the Peak to Average Power Ratio:

1. Connect a signal to the YBT250 RF INPUT connector. See page 2-24 for connection instructions.
2. Select the Measure window (button 1).
3. Tap **Select Measurement**.
4. Tap **Peak/Average**. See Figure 3-42.

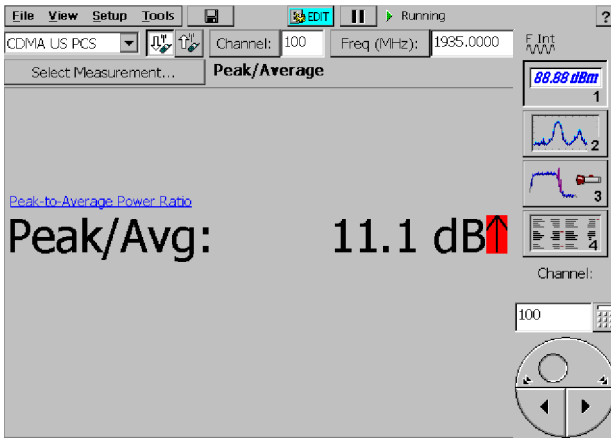

Figure 3-42: A typical Peak to Average Power Ratio display

5. Select Forward Link ().
6. Select the Signal Standard.

7. Select the Channel:
 - a. Tap the Channel box. This assigns the numeric keypad and knob to Channel.
 - b. Tap the numeric keypad to enter the channel number directly or use the knob to change the channel number.

Measuring Carrier Frequency

Requires an RF Measurement Option

The Carrier Frequency measurement actually displays three measurements: carrier frequency and frequency error expressed in frequency and parts per million (ppm). In addition, if a valid external reference frequency is present (see page 2-26), the frequency of the external reference is also displayed.

The Carrier Frequency is the actual measured frequency for the selected channel. If the measurement frequency is not within the selected channel (indicated by a black background in the Channel box), a warning is displayed.

Frequency Error is the difference in frequency between the measured frequency of the selected channel and the frequency assigned to the channel in the Channel Table file. Excessive frequency error can prevent demodulation of the received signal. The Frequency Error measurement can only be made on channels in the current Channel Table. If a carrier is not detected close to the Measurement Frequency, the measurement cannot be made and an error message is displayed.

To measure the carrier frequency:

1. Connect a signal to the YBT250 RF INPUT connector. See page 2-24 for connection instructions.
2. If desired, connect a cable from the BTS transmitter External Frequency Reference signal (see page 2-26 for a list of acceptable frequencies) to the FREQUENCY REFERENCE INPUT on the YBT250.
3. Select the Measure window (button 1).

4. Tap **Select Measurement**.
5. Tap **Carrier Frequency**. See Figure 3-43.
6. Select Forward Link ().
7. Select the Signal Standard.
8. Select the Channel:
 - a. Tap the Channel box. This assigns the numeric keypad and knob to Channel.
 - b. Tap the numeric keypad to enter the channel number directly or use the knob to change the channel number.

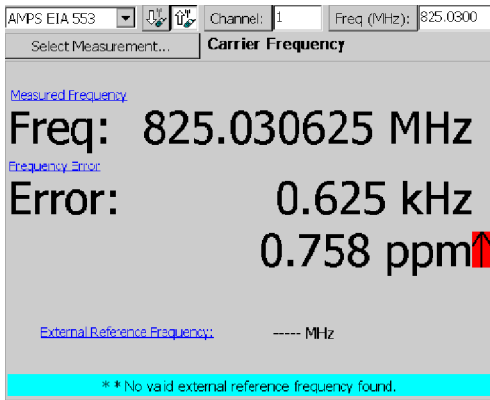

Figure 3-43: A Carrier Frequency display

NOTE. *If the YBT250 indicates there is no signal when the Signal Standard is set to W-CDMA, verify that the Scrambling Code setting is correct. If it is set to Manual and the wrong value is entered for the scrambling code, the YBT250 will not find a signal. The YBT250 will not show signals with other scrambling codes when the scrambling code is set to Manual.*

Measuring Occupied Bandwidth

Requires an RF Measurement Option

One way to check the spectral response of the transmitter is to measure the Occupied Bandwidth. The YBT250 enables you to check the signal width of the selected signal using the Occupied Bandwidth measurement.

The Occupied Bandwidth is the frequency range where 99% of the power transmitted in a single channel lies. This measurement can be properly made only if the channel being measured has no active channels adjacent to it. If there is a signal in either channel adjacent to the selected channel, the signal will add power to the measurement, thus resulting in an inaccurate measurement.

To measure the Occupied Bandwidth:

1. Connect a signal to the YBT250 RF INPUT connector. See page 2-24 for connection instructions.
2. Select the Measure window (button 1).
3. Tap **Select Measurement**.
4. Tap **Occupied Bandwidth**. See Figure 3-44.
5. Select Forward Link ().
6. Select the Signal Standard.
7. Select the Channel:
 - a. Tap the Channel box. This assigns the numeric keypad and knob to Channel.
 - b. Tap the numeric keypad to enter the channel number directly or use the knob to change the channel number.

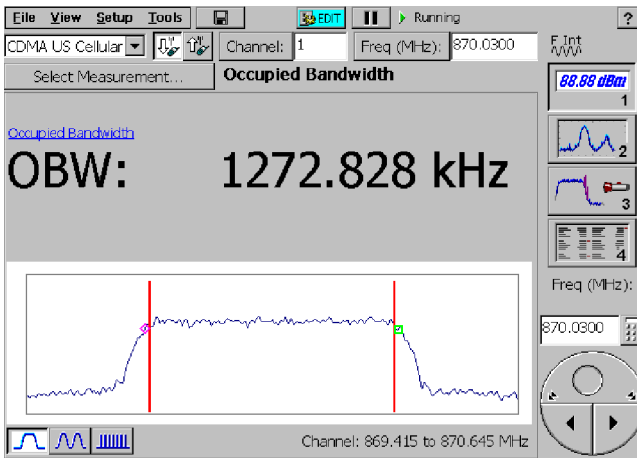





Figure 3-44: A typical Occupied Bandwidth display

The two markers indicate the left and right edges of the measurement.

The vertical bars in the display represent the upper and lower limits of the specified channel. You can change the horizontal range of the display by selecting one of the three buttons in the lower-left corner of the display:

- Select  to change the horizontal range to one channel width plus half a channel or either side.
- Select  to change the horizontal range to just over five channels.
- Select  to set the horizontal range to 10 MHz or 10 channel widths, whichever is greater.

Measuring cdmaOne and cdma2000 Signal Quality

Requires Option CD1, Demodulation for cdmaOne or Option CD2, Demodulation for cdma2000

For cdmaOne and cdma2000 signal quality, the measurements performed are: Waveform Quality (Rho), Error Vector Magnitude, Pilot time Alignment, PN Offset and Carrier Feedthrough.

To measure signal quality:

1. Select the appropriate CDMA Signal Standard.
2. Connect a signal to the YBT250 RF INPUT connector. See page 2-24 for connection instructions.
3. Select the Measure window (button 1).
4. Tap **Select Measurement**.
5. Tap **Signal Quality**.
6. Select the Method to use for measuring Signal Quality:
 - Select **Pilot only, no other codes active** on input signal for Pilot-only signals.
 - Select **Auto detect active codes** for an in-service signal quality measurement.
7. Select Forward Link ().
8. Connect the BTS transmitter Even Second Clock to the TIMING INPUT connector on the YBT250.
9. Select the Channel:
 - a. Tap the Channel box. This assigns the numeric keypad and knob to Channel.
 - b. Tap the numeric keypad to enter the channel number directly or use the knob to change the channel number.

See Figure 3-45.

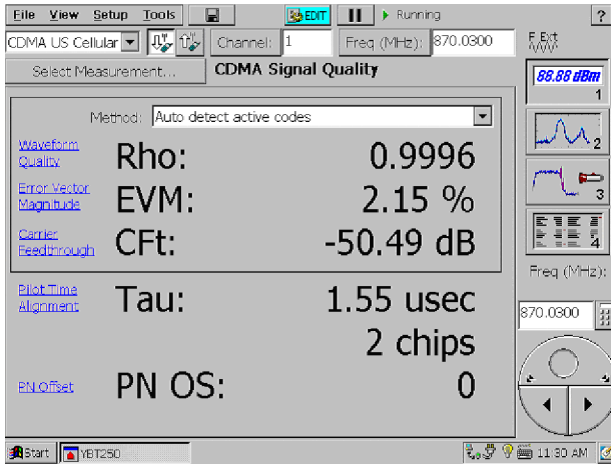

Figure 3-45: A Signal Quality display

NOTE. True signal quality, Rho, should be measured only on a pilot-only signal. If the YBT250 detects active codes in the signal and Autodetect Active codes is selected, it will make the Estimated Rho measurement.

Measuring W-CDMA Signal Quality

Requires Option WD1, Demodulation for W-CDMA

For W-CDMA signal quality, the measurements performed are: Error Vector Magnitude, Carrier Feedthrough, and Scrambling Code.

To measure signal quality:

1. Select the appropriate W-CDMA Signal Standard.
2. Connect a signal to the YBT250 RF INPUT connector. See page 2-24 for connection instructions.
3. Select the Measure window (button 1).

4. Tap **Select Measurement**.
5. Tap **Signal Quality**.
6. Select Forward Link ().
7. Select the Channel:
 - a. Tap the Channel box. This assigns the numeric keypad and knob to Channel.
 - b. Tap the numeric keypad to enter the channel number directly or use the knob to change the channel number.

See Figure 3-46.

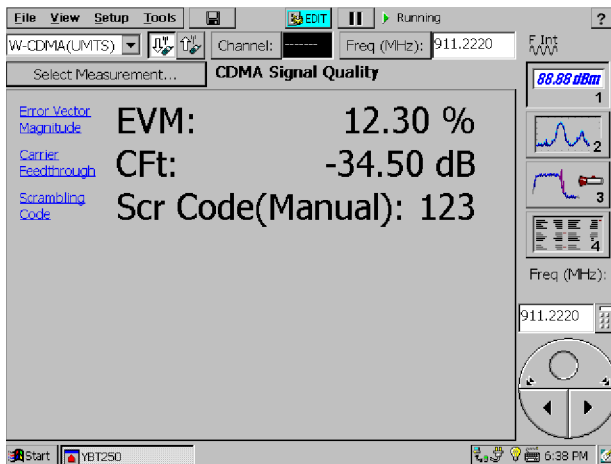

Figure 3-46: A Signal Quality display

The EVM measurement will be most accurate when using the conformance test model for EVM, Test Model 4. Test Model 4 specifies that the only active channels are the P-CCPCH and SCH channels, with the P-CPICH channel present as an option. The P-CPICH must be present for the YBT250 to make an EVM measurement.

The EVM measurement can be made on signals other than Test Model 4, but the result will be an estimate of the true EVM value. The YBT250 will attempt to determine the spreading factor of all active codes and the power levels during one time slot. Changing power levels or codes with low power levels will decrease the accuracy of the EVM estimate.

The EVM measurement is an average of the last ten data points. When you change a setting, the queue of the last ten data points is flushed. While the queue is filling, the help link text includes “***” and the message “***EVM result being averaged - please wait” is displayed. This message goes away after ten data points are available to average (this might require several seconds). Until this averaging is completed, the EVM result will exhibit more variation.

Measuring cdma2k 1xEV-DO Signal Quality

Requires Option CDE, Demodulation for cdma2k 1xEV-DO

For W-CDMA signal quality, the measurements performed are: Error Vector Magnitude, Carrier Feedthrough, and Scrambling Code.

The YBT250 provides several measurements of signal quality for cdma2000 1xEV-DO signals.

The measurements performed are:

- Waveform Quality (Rho)
- Error Vector Magnitude (EVM)
- Data Constellation Type
- PN Offset (PNOS)
- Pilot Time Alignment Error (Tau)

You must have an appropriate Timing Reference input (Even Second Clock) to measure PNOS and Timing Error.

To measure signal quality:

1. Select the appropriate 1xEV-DO Signal Standard.
2. Connect a signal to the YBT250 RF INPUT connector. See page 2-24 for connection instructions.
3. Select the Measure window (button 1).
4. Tap **Select Measurement**.
5. Tap **Signal Quality**.
6. Select Forward Link ().
7. Select the Channel:
 - a. Tap the Channel box. This assigns the numeric keypad and knob to Channel.
 - b. Tap the numeric keypad to enter the channel number directly or use the knob to change the channel number.

See Figure 3-47.

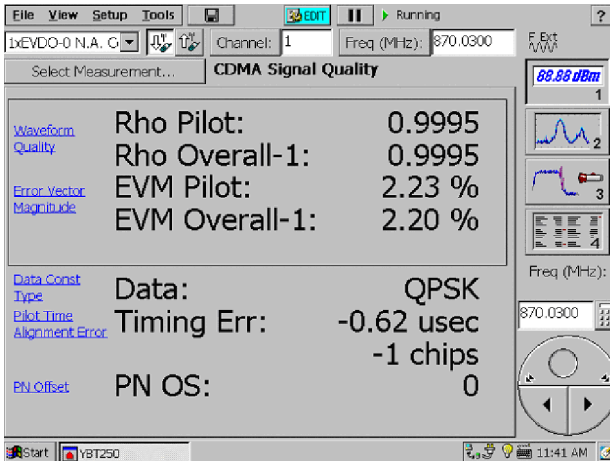

Figure 3-47: Signal Quality display for 1xEV-DO

Pilot Rho and Pilot EVM are measured on the Pilot interval of 20 half-slots. Since Pilot is always transmitted, these results are available on every signal measurement attempt.

Overall-1 Rho and Overall-1 EVM are measured on one complete non-idle slot (two half-slots). If a non-idle slot cannot be found in the acquired signal, the Overall-1 measurements are not made, and will be marked "----" for that result update.

Waveform Quality (Rho)

The Waveform Quality measurement is an indication of how similar the transmitted signal is to a perfect signal. Rho can vary between 0.0 and 1.0, where 1.0 represents a perfect signal. There are two Rho measurements computed on a 1xEV-DO signal. Pilot Rho is only computed on chips in the Pilot intervals of the waveform, similar to Pilot-only Rho of cdmaOne and cdma2000. Overall-1 Rho is computed on all chips of one non-idle (active data) slot waveform, including pilot, MAC, and data intervals. Overall-1 Rho is only computed when a non-idle slot is detected in the input signal.

Error Vector Magnitude (EVM)

Error Vector Magnitude is the RMS value of all the vectors that extend from the ideal constellation points to the received signal constellation points in a record of demodulated CDMA symbols, divided by the RMS value of the signal. This result is multiplied by 100 to give a final value in percent. An EVM value of 0.0% represents a perfect signal.

There are two EVM measurements computed on a 1xEV-DO signal:

- Pilot EVM is only computed on chips in the Pilot intervals of the waveform.
- Overall-1 EVM is computed on all chips of one non-idle (active data) slot waveform, including pilot, MAC, and data intervals. Overall-1 EVM is only computed when a non-idle slot is detected in the input signal.

Data Constellation Type

Data Constellation Type identifies the constellation type used to encode the user data bits in the data interval of a non-idle slot. Constellation type can be QPSK, 8PSK or 16QAM.

PN Offset

PN Offset is the time difference, measured in 64 PN-chip intervals, between the Even Second Clock pulse and the first chip of the next complete short-code PN spreading sequence in the signal, as observed at the YBT250 RF input port. PN Offset values are integer numbers with a range of 0 to 511.

Pilot Time Alignment Error (Tau)

The Pilot Time Alignment Error measures the difference between an ideal signal with PN timing exactly aligned to a PN Offset location, and the received signal as observed at the YBT250 RF input port. The difference is the residual timing error of the received signal from the nearest legal PN Offset. The error is expressed in both microseconds and equivalent number of chips.

Measuring GSM/EDGE Signal Quality

Requires Option EM1

For GSM/EDGE signal quality, the measurements performed are: Phase Error, Error Vector Magnitude, Origin Offset, and Carrier to Interference ratio (C/I).

To measure signal quality:

1. Select the appropriate GSM standard.
2. Connect a signal to the YBT250 RF INPUT connector. See page 2-24 for connection instructions.
3. Select the Measure window (button 1).
4. Tap **Select Measurement**.
5. Tap **Signal Quality**. See Figure 3-48.

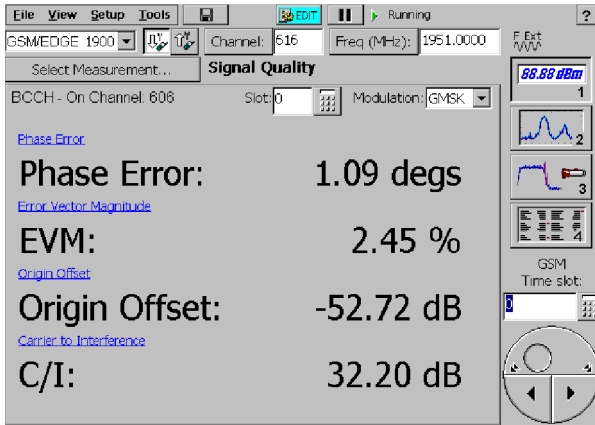



Figure 3-48: GSM/EDGE Signal Quality measurement

6. Select Forward Link ()
7. Select the Channel:
 - a. Tap the Channel box. This assigns the numeric keypad and knob to Channel.
 - b. Tap the numeric keypad to enter the channel number directly or use the knob to change the channel number.
8. Tap the Slot field keypad icon to enter the slot number to measure.
9. Tap the Modulation field to select the modulation type to detect.

NOTE. To search for the modulation type in all slots, instead of only the specified slot, set the BCCH Frame Sync control to Off.

Phase Error

Phase Error is the RMS value of the differences (in degrees) between the phase angles of the received signal and those of an ideal reconstructed reference signal of the specified slot.

Error Vector Magnitude (EVM)

Error Vector Magnitude is the RMS value (in percent) of all the vectors that extend from the ideal constellation points to the received signal constellation points in a record of demodulated GSM/EDGE symbols, divided by the RMS value of the signal. An EVM value of 0.0% represents a perfect signal.

Origin Offset

Origin Offset is the ratio (in dBs) of unmodulated signal power to modulated signal power. The measurement name refers to the offset of the signal constellation center that is caused by the unmodulated signal component.

Carrier to Interference Ratio (C/I)

Carrier to Interference ratio (C/I) is the ratio of desired signal (carrier) power to undesired signal (interference) power, in dB units. The NetTek C/I value is derived from the EVM result, and gives an estimate of the power-based C/I value.

Measuring cdmaOne Code Power

Requires Option CD1, Demodulation for cdmaOne

The Code Domain Power measurement displays a graph that indicates the power on each Walsh Code in the channel. The Code Domain Power graph highlights the Pilot, Paging, and Sync channels for easy identification. The graph also highlights active code channels based on a -27 dB (relative to total power) threshold. You can use the cursor to display the exact power on any one specified code.

To display the Code Domain Power:

1. Connect a signal to the YBT250 RF INPUT connector. See page 2-24 for connection instructions.
2. Select the Measure window (button 1).
3. Set the Signal Standard to the appropriate CDMA standard.
4. Tap **Select Measurement**. This displays the Select Signal Standard and Measurement dialog box.
5. Tap **Code Power**. See Figure 3-49.

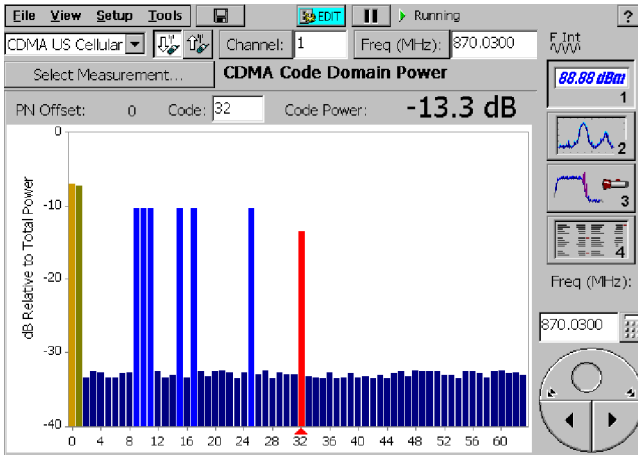

Figure 3-49: cdmaOne Code Domain Power display

6. Select the Channel:
 - a. Tap the Channel button to display the channel number keypad.
 - b. Specify the channel number. To display a list of all the available channels for the selected standard, tap **List**.

- c. From the Select Channel dialog box, select the channel to display and tap **OK**.
7. To select which Code to measure:
 - Tap the **Code** box to assign the numeric keypad and knob to Code. Use the numeric keypad or knob to set the number of the Code to be measured.
 - Or tap in the graph on the Code of interest.

Measuring cdma2000 Code Power

Requires Option CD2, Demodulation for cdma2000

The Code Domain Power measurement for cdma2000 standards displays graphs that indicate the power on each code in the signal. Code Domain Power is displayed on two graphs, the Walsh Code graph and the Bit-reversed graph. The YBT250 displays the exact power on any specified code relative to the Total Power or the Pilot Power. You specify which signal to use as a reference for the Code Power on the **Meter** tab of the Setup window.

To display the Code Domain Power:

1. Connect a signal to the YBT250 RF INPUT connector. See page 2-24 for connection instructions.
2. Select the Measure window (button 1).
3. Set the Signal Standard to the appropriate cdma2000 standard.
4. Tap **Select Measurement**. This displays the Select Signal Standard and Measurement dialog box.
5. Tap **Code Power**. See Figure 3-50.

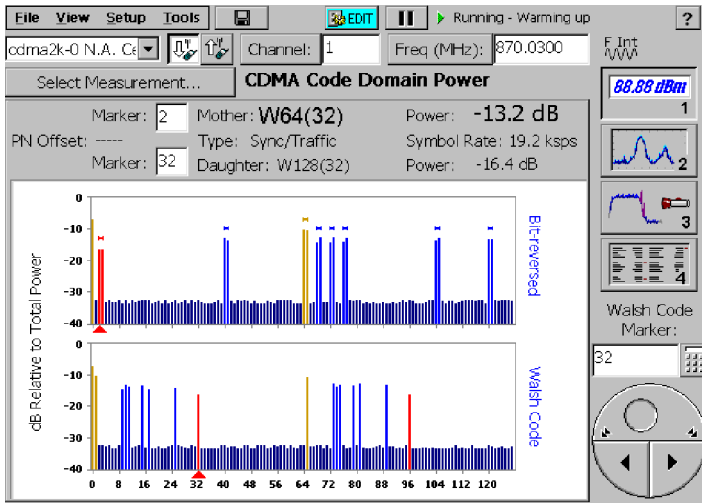

Figure 3-50: cdma2000 Code Domain Power display

6. Select the Channel:

- a. Tap the Channel button to display the channel number keypad.
- b. Specify the channel number. To display a list of all the available channels for the selected standard, tap **List**.
- c. From the Select Channel dialog box, select the channel to display and tap **OK**.

7. To select which Code to measure:
 - a. Tap the text box corresponding to either Mother or Daughter code readout to assign the knob to the desired graph.

Or tap the Walsh Code graph or Bit-reversed graph to assign the knob to the desired graph.
 - b. Set the number of the Code to be measured using the knob or the numeric keypad.

Or tap in the appropriate graph on the Code of interest.

NOTE. *To display the power for a specific code, you may find it easier to tap the Code: box and select a code by using the knob rather than tapping the graph.*

Code Domain Power Readouts

Mother. Displays the detected spreading factor and base code for the selected Walsh code.

Daughter. Displays the spreading factor and code index for the selected Walsh code at maximum spreading factor.

Code Power. Displays the measured power for the selected code, with 0.1 dB resolution. Note that there are two power readouts: one for the Mother code and one for the Daughter code. The Mother code power readout displays the total power for the selected code at its actual spreading factor. The Daughter code power readout displays the power in the selected code at the maximum spreading factor.

Symbol Rate. Displays a calculated number equal to the chip rate divided by the spreading factor.

PN Offset. Displays the “coarse” timing difference between the pilot channel and the even-second clock.

Type. Indicates the purpose of the selected code. See the following table.

Table 3-8: cdma2000 channel types

| Displayed type | Spreading factor | Codes(s) | Description |
|----------------------------|------------------|-------------|--|
| Forward Pilot | 64 | 0 | May appear as W128(0) |
| Tx Diversity Pilot/Traffic | 128 | 16 | |
| Sync/Traffic | 64 | 32 | May appear as W128(32) |
| Paging/Traffic | 64 | 1-7 | |
| Quick Paging/Traffic | 128 | 48, 80, 112 | |
| Traffic | 4-128 | 0-127 | Any active code not matching above Spreading Factors or code numbers |
| Inactive | 128 | 0-127 | Power below threshold |

Measuring W-CDMA Code Power

Requires Option WD1, Demodulation for W-CDMA

The Code Domain Power measurement for W-CDMA displays graphs that indicate the power on each Orthogonal Variable Spreading Factor (OVSF) code in the signal. Code Domain Power is displayed in two graphs. The bottom graph shows the Code Domain Power in all OVSF codes; the top graph shows a zoomed in Code Domain Power display of one fourth of the OVSF codes.

The horizontal scroll bar below the lower graph indicates the zoom range of the upper graph; you can drag the horizontal scroll bar to change the zoomed range of the upper graph. Also, you can tap a point in either graph to move the marker to that point. If that point is not shown in the zoom range, the zoom range will recenter around that point.

The YBT250 displays the exact power on any specified code relative to the Total Power or the Pilot Power (power in the P-CPICH channel). You specify which signal to use as a reference for the Code Power on the Meter tab of the Setup window. The maximum spreading factor is also selected in the Setup window.

To display the Code Domain Power graph:

1. Connect a signal to the YBT250 RF INPUT connector. See page 2-24 for connection instructions.
2. Select the Measure window (button 1).
3. Select the appropriate W-CDMA Signal Standard.
4. Tap **Select Measurement**. This displays the Select Signal Standard and Measurement dialog box.
5. Tap **Code Power**. See Figure 3-51.

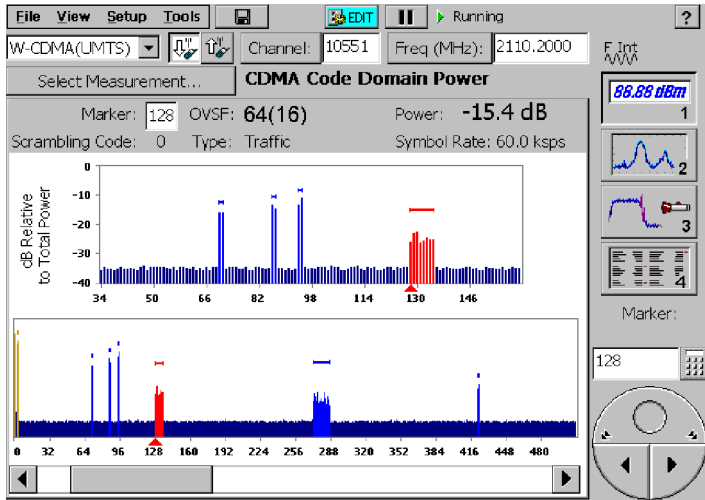

Figure 3-51: W-CDMA Code Domain Power display

6. Select the Channel:
 - a. Tap the Channel button to display the channel number keypad.
 - b. Specify the channel number. To display a list of all the available channels for the selected standard, tap **List**.

- c. From the Select Channel dialog box, select the channel to display and tap **OK**.
7. To select which Code to measure:
- a. Tap the text box by the OVSF code readout to assign the knob to OVSF code selection.
 - b. Or tap the full or zoomed graph to assign the knob to both graphs.
 - c. Set the number of the Code to be measured using the knob or the numeric keypad.
 - d. Or tap in the appropriate graph on the Code of interest.

Code Domain Power Readouts

Marker. Indicates and controls the position of the marker in the code display graphs.

OVSF. Displays the detected spreading factor and code index for the OVSF code selected by the marker.

Power. Displays the measured power for the selected code based on the detected spreading factor.

Scrambling Code. The detected primary scrambling code number.

Symbol Rate. Displays a calculated number equal to the chip rate divided by the spreading factor.

Type. Indicates the purpose of the selected code. See the following table.

Table 3-9: cdma2000 channel types

| Displayed type | Spreading factor | Codes(s) | Description |
|-----------------|------------------|----------|--|
| Primary Pilot | 256 | 0 | May appear as 512(0). This is the P-CPICH channel. |
| Primary Control | 256 | 1 | This is the P-CCPCH channel. |

Table 3-9: cdma2000 channel types (Cont.)

| Displayed type | Spreading factor | Codes(s) | Description |
|----------------|------------------|----------|--|
| Traffic | 4-512 | 0-511 | Any active code not matching above Spreading Factors or code numbers |
| Inactive | 512 | 0-511 | Power below threshold |

NOTE. To display the power for a specific code, you may find it easier to tap the Marker: box and select a code by using the knob rather than tapping the graph.

In W-CDMA mode, the synchronization channels (P-SCH and S-SCH) are not assigned OVFSF codes and therefore they will not appear in the Code Domain Power display. To see the power in the sync channels, see Measuring W-CDMA Pilot Power and Sync Powers on page 3-117.

Measuring cdma2k 1xEV-DO Code Power

Requires Option CDE, Demodulation for W-CDMA

The Code Domain Power measurement for 1xEV-DO displays a graph showing the power in each of the 64 MAC code channels, relative to the total power of the signal. The display shows the MAC index number in the horizontal axis, and the power of each code channel level by the height of the corresponding bar.

In addition to the MAC Code Domain Power graph, numeric readouts of the minimum and maximum Data interval Code Domain Power values are displayed, when a slot with non-idle data content is detected in the acquired signal. Data CDP minimum and maximum levels can be compared to limits to detect signal errors. If no non-idle half-slots are detected in an acquisition, Data Code Power results are set to "-----".

To display the MAC Code Domain Power graph and Data Code Domain Power results:

1. Connect a signal to the YBT250 RF INPUT connector. See page 2-24 for connection instructions.
2. Select the Measure window (button 1).
3. Select the 1xEV-DO Signal Standard.
4. Tap **Select Measurement**. This displays the Select Signal Standard and Measurement dialog box.
5. Tap **Code Power**. See Figure 3-52.

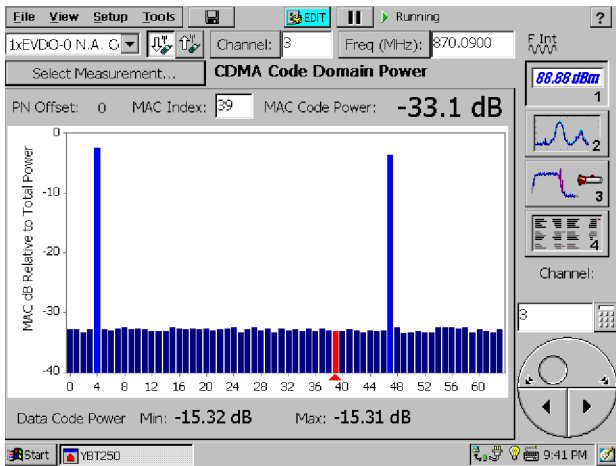

Figure 3-52: 1xEV-DO Code Domain Power display

6. Select the Channel:
 - a. Tap the Channel button to display the channel number keypad.
 - b. Specify the channel number. To display a list of all the available channels for the selected standard, tap **List**. See Figure 3-53.

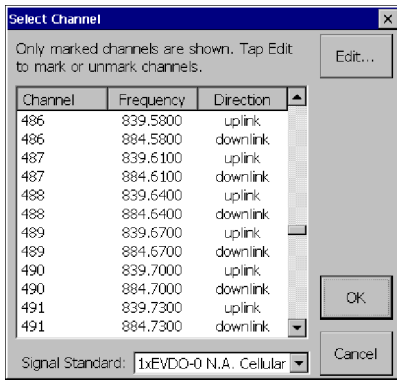

Figure 3-53: Displaying a list of the available channels

- c. Select the channel to display and tap **OK**.
7. To select which MAC Channel Code to measure:
 - a. Tap the text box by the MAC Index readout to assign the knob to MAC channel code selection. (Or tap the graph to assign the knob to the graph.)
 - b. Set the number of the Code to be measured using the knob or the numeric keypad. (Or tap in the graph on the Code of interest.)

Code Domain Power Readouts

PN Offset. The “coarse” timing difference between the pilot channel and the even-second clock.

MAC Index. Displays the MAC index number of the selected code.

MAC Code Power. Displays the measured power for the selected code with 0.1 dB resolution.

Data Code Power Min and Max. Show the the minimum and maximum code domain power values (of both real and imaginary components, relative to total signal power) in the set of 16 Walsh codes used in the data portions of non-idle half slots.

NOTE. *To display the power for a specific code, you may find it easier to tap the Code box and select a code by using the knob rather than tapping the graph.*

Displaying a cdmaOne Codogram

Requires Option CD1, Demodulation for cdmaOne

A codogram displays how code levels change over time. Because the codogram displays how code power changes over time, the codogram makes it easier to spot faults and monitor traffic and hand-off activity over time.

To display a CDMA codogram.

1. Connect a signal to the YBT250 RF INPUT connector. See page 2-24 for connection instructions.
2. Select the Measure window (button 1).
3. Set the Signal Standard to the appropriate CDMA standard.
4. Tap **Select Measurement**. This displays the Select Signal Standard and Measurement dialog box.
5. Tap **Codogram**. See Figure 3-54.

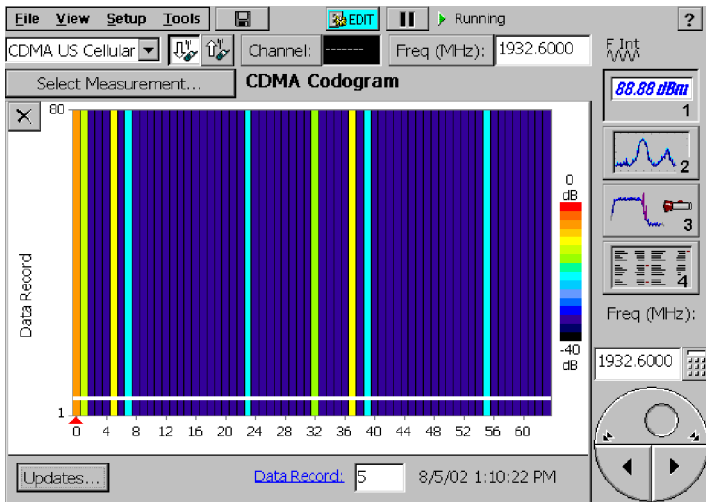

Figure 3-54: cdmaOne Codogram display

6. Select the Channel:

- a. Tap the Channel button to display the channel number keypad.
- b. Specify the channel number. To display a list of all the available channels for the selected standard, tap **List**.
- c. In the Select Channel dialog box, select the channel to display and tap **OK**.

Hints

- Tap the Restart icon (✕) to clear the trace history and restart collecting data.
- Select **Updates...** to change how often the codogram is updated.
- To find the timestamp (displayed next to the Data Record box) for a specific data record in the Codogram, tap the **Data Record** box. The cursor is a white band of the same height as a data record. Use the knob or numeric keypad to move the cursor so

that it covers up the data record of interest. The time and date the data was recorded is displayed to the right of the Data Record box.

- You can save a codogram to a file every 80 records, by setting the option on the Meter tab of the Setup window.

Displaying a cdma2000 Codogram

Requires Option CD2, Demodulation for cdma2000

A Codogram displays how code levels change over time. Because the Codogram displays how code power changes over time, the Codogram makes it easier to spot faults and interference. For cdma2000 standards, the YBT250 displays two codograms, one by Walsh Code and one by bit-reversed code.

To display a CDMA codogram.

1. Connect a signal to the YBT250 RF INPUT connector. See page 2-24 for connection instructions.
2. Select the Measure window (button 1).
3. Set the Signal Standard to the appropriate cdma2000 standard.
4. Tap **Select Measurement**. This displays the Select Signal Standard and Measurement dialog box.
5. Tap **Codogram**. See Figure 3-55.

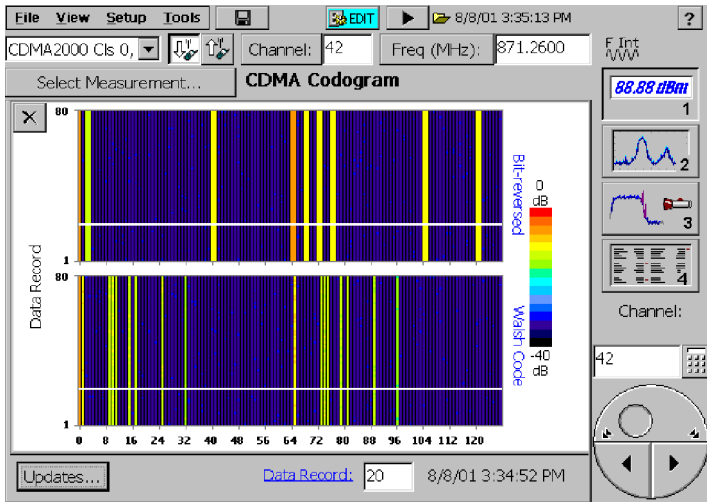

Figure 3-55: cdma2000 Codogram display

6. Select the Channel:
 - a. Tap the Channel button to display the channel number keypad.
 - b. Specify the channel number. To display a list of all the available channels for the selected standard, tap **List**.
 - c. Select the channel to display and tap **OK**.

Hints

- Tap the Restart icon (✕) to clear the trace history and restart collecting data.
- Select **Updates...** to change how often the codogram is updated.
- To find the timestamp (displayed next to the Data Record box) for a specific data record in the Codogram, tap the **Data Record** box. The cursor is a white band of the same height as a data record. Use the knob or numeric keypad to move the cursor so that it covers the data record of interest.

The time and date the data was recorded is displayed to the right of the Data Record box.

- You can save a codogram to a file every 80 records, by setting the option on the Meter tab of the Setup window.

Displaying a W-CDMA Codogram

Requires Option WD1, Demodulation for W-CDMA

The Codogram display shows changes in code power levels over time. You can use it to monitor activity and spot faults and interference during time intervals that you define.

For W-CDMA standards, the YBT250 displays two codograms, one of all the OVSF codes and one zoomed in showing one-fourth of the possible codes.

The horizontal scroll bar below the lower graph indicates the zoom range of the upper graph; you can drag the horizontal scroll bar to change the zoomed range of the upper graph. Also, you can tap a point in either graph to move the marker to that point. If that point is not shown in the zoom range, the zoom range will recenter around that point.

To display a W-CDMA codogram.

1. Connect a signal to the YBT250 RF INPUT connector. See page 2-24 for connection instructions.
2. Select the Measure window (button 1).
3. Set the Signal Standard to the appropriate cdma2000 standard.
4. Tap **Select Measurement**. This displays the Select Signal Standard and Measurement dialog box.
5. Tap **Codogram**. See Figure 3-56.

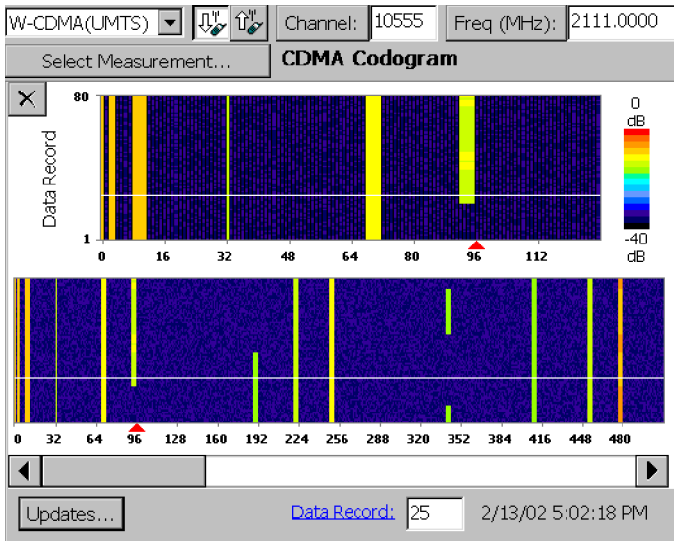

Figure 3-56: W-CDMA Codogram display

6. Select the Channel:

- a. Tap the Channel button to display the channel number keypad.
- b. Specify the channel number. To display a list of all the available channels for the selected standard, tap **List**.
- c. Select the channel to display and tap **OK**.

Hints

- Tap the Restart icon (⊗) to clear the trace history and restart collecting data.
- Select **Updates...** to change how often the codogram is updated.
- To find the timestamp (displayed next to the Data Record box) for a specific data record in the Codogram, tap the **Data Record** box. The cursor is a white band of the same height as a data record. Use the knob or numeric keypad to move the cursor so

that it covers up the data record of interest. The time and date the data was recorded is displayed to the right of the Data Record box.

- You can save a codogram to a file every 80 records, by setting the option on the Meter tab of the Setup window.

Displaying a cdma2k 1xEV-DO Codogram

Requires Option CDE, Demodulation for cdma2k 1xEV-DO

A Codogram displays changes in code levels over time, making it easier to spot and record intermittent faults and interference. For 1xEV-DO signals, the YBT250 displays a codogram of the MAC channel codes.

To display a 1xEV-DO codogram:

1. Connect a signal to the YBT250 RF INPUT connector. See page 2-24 for connection instructions.
2. Select the Measure window (button 1).
3. Set the Signal Standard to cdma2k 1xEV-DO.
4. Tap **Select Measurement**. This displays the Select Signal Standard and Measurement dialog box.
5. Tap **Codogram**. See Figure 3-57.

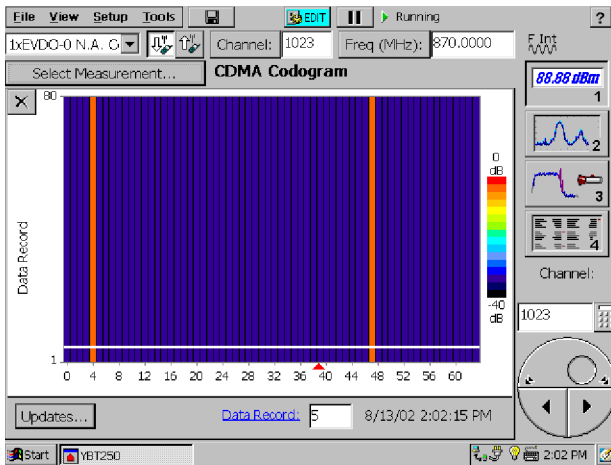

Figure 3-57: 1xEV-DO codogram display

6. Select the Channel:

- a. Tap the Channel button to display the channel number keypad.
- b. Specify the channel number. To display a list of all the available channels for the selected standard, tap **List**.
- c. In the Select Channel dialog box, select the channel to display and tap **OK**.

Hints

- Tap the Restart icon (✕) to clear the trace history and restart collecting data.
- Select **Updates...** to change how often the codogram is updated.
- To find the timestamp (displayed next to the Data Record box) for a specific data record in the Codogram, tap the **Data Record** box. The cursor is a white band of the same height as a data record. Use the knob or numeric keypad to move the cursor so that it covers up the data record of interest.

The time and date the data was recorded is displayed to the right of the Data Record box.

- You can save a codogram to a file every 80 records, by setting the option on the Meter tab of the Setup window.

Automatically Saving the cdmaOne, cdma2000, 1xEV-DO, and W-CDMA Codogram Displays

You can set the YBT250 to automatically save the cdmaOne/ cdma2000, 1xEV-DO, and W-CDMA codogram displays each time 80 records are accumulated. Files are automatically named as they are saved, enabling unattended operation.

To automatically save the codogram display every 80 records:

1. Select **Setup > Edit**. This displays the Setup window.
2. Tap the **Meter** tab. See Figure 3-58.

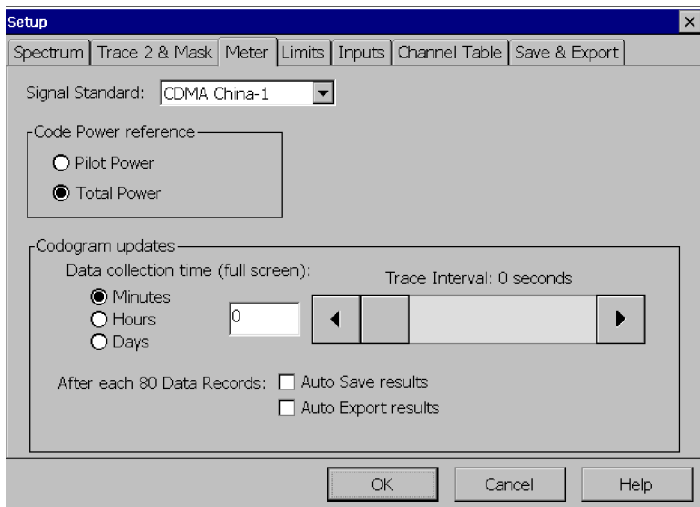

Figure 3-58: Meter tab of the setup window

3. To automatically save or export after you've taken 80 records, tap the check box next to **Auto Save** or **Auto Export**.
4. Tap **OK** to save your changes.

The YBT250 will save the codogram display to a new file each time 80 data records are accumulated. The time required to accumulate depends on the codogram update rate. Refer to Table 3-10 for the approximate file sizes for codograms.

Table 3-10: Typical codogram file sizes

| Signal standard | Typical saved file size | Typical exported file size |
|------------------------------|-------------------------|----------------------------|
| cdmaOne cdma2k 1xEV-DO | 8.5 kilobytes | 25 kilobytes |
| cdma2000 | 40 kilobytes | 124 kilobytes |
| W-CDMA ¹ | 92 kilobytes | 317 kilobytes |

¹ **These are typical file sizes for a maximum spreading factor of 512, the highest possible setting.**

Printing Trace Screens

While the **Outdoor Viewing** or **Indoor Viewing** color schemes are well suited for viewing a trace screen on a color display (see Figure 3-59), if you want to print a trace screen on a black and white printer (for example, a laser printer), you should select either the **Monochrome grays** or **Black on White for printer** color scheme (**Tools > Options > Preferences**) for a better printout. When the **Monochrome grays** or **Black on White for printer** color scheme is used, a trace screen will appear with colors that are optimized for printing on black and white printers.

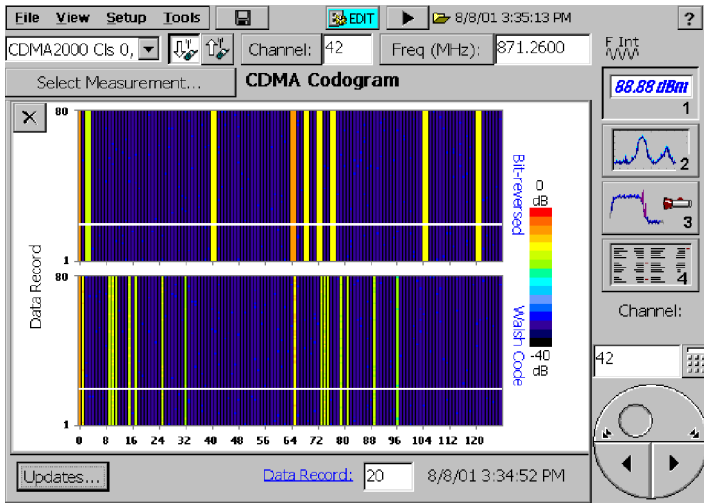

Figure 3-59: Codogram displayed with Bright on White color scheme

After you have set the color scheme for **Monochrome grays** or **Black on White for printer**, the trace screen will appear with altered colors. Figure 3-60 is the same codogram as Figure 3-59 except the color scheme has been set to **Monochrome grays**. Note that in the **Monochrome grays** color scheme, the highest signal level is the lightest color. But in the **Dark on white** color scheme, the lightest color is *not* the highest signal level. This distinction is easily seen in the printed version of this manual, though not in the PDF version which shows what a color display would look like.

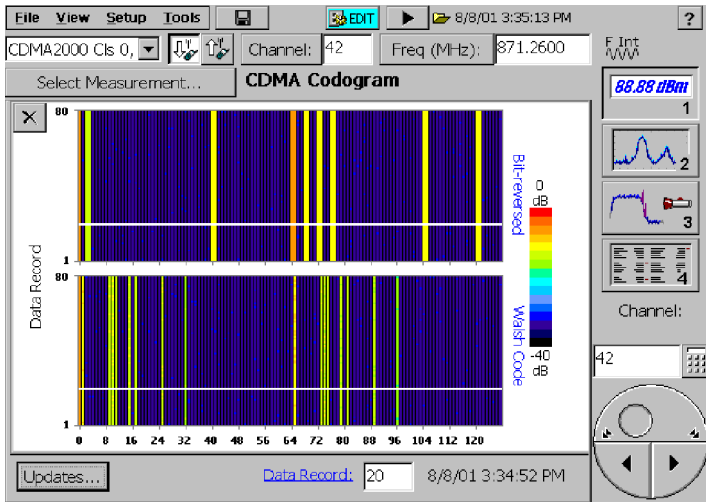

Figure 3-60: Codogram displayed with Monochrome grays color scheme

Measuring cdmaOne and cdma2000 Pilot Power

Requires Option CD1, Demodulation for cdmaOne or Option CD2, Demodulation for cdma2000

The Pilot Power measurement displays the amount of transmitted power in the CDMA pilot code (Walsh code 0). It can be measured on signals with any combination of active codes. The YBT250 displays the Pilot Power, Channel Power and the difference between pilot and total.

To measure Pilot Power:

1. Connect a signal to the YBT250 RF INPUT connector. See page 2-24 for connection instructions.
2. Select the Measure window (button 1).
3. Set the Signal Standard to the appropriate CDMA standard.
4. Tap **Select Measurement**.

5. Tap **Pilot Power**. See Figure 3-61.

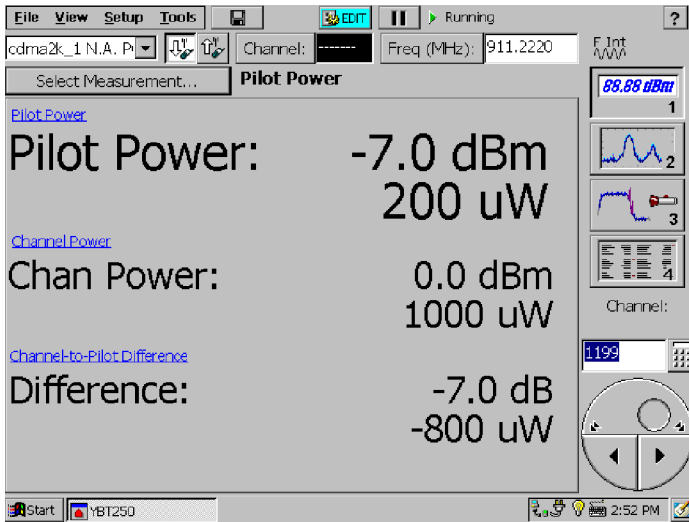



Figure 3-61: A typical Pilot Power display

6. Select Forward Link ().
7. Select the Channel:
 - a. Tap the Channel box. This assigns the numeric keypad and knob to Channel.
 - b. Tap the numeric keypad to enter the channel number directly or use the knob to change the channel number.

Measuring W-CDMA Pilot Power and Sync Powers

Requires Option WD1, Demodulation for W-CDMA

Pilot power is the power in the P-CPICH channel. Sync power is power in the P-SCH and S-SCH channels.

To measure Pilot Power and Sync Powers:

1. Connect a signal to the YBT250 RF INPUT connector. See page 2-24 for connection instructions.
2. Select the Measure window (button 1).
3. Set the Signal Standard to the appropriate W-CDMA standard.
4. Tap **Select Measurement**.
5. Tap **Pilot Power**. See Figure 3-62.

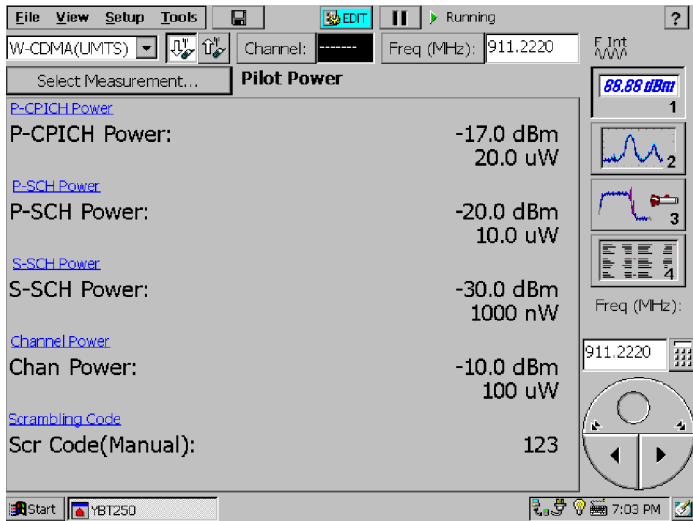

Figure 3-62: A typical W-CDMA Pilot Power display

6. Select the Channel:
 - a. Tap the Channel box. This assigns the numeric keypad and knob to Channel.
 - b. Tap the numeric keypad to enter the channel number directly or use the knob to change the channel number.

Measuring W-CDMA ACLR

Requires Option WR1, RF Measurements for W-CDMA

ACLR (Adjacent Channel Leakage Ratio) is the ratio of the mean signal power in the assigned channel (5 MHz bandwidth) to the mean power in an adjacent channel of equal bandwidth. To simulate the filter response of a receiver, a Root Raised Cosine (RRC) filter response with an equivalent noise bandwidth of 3.84 MHz is applied before computing the mean power of each channel.

Four adjacent channels, the two closest on either side of the assigned channel, are measured: the Upper1/Lower1 adjacent channels are centered 5 MHz above and below the assigned channel center, and the Upper2/ Lower2 channels are 10 MHz above and below the assigned channel center.

Each ACLR result is computed by subtracting the corresponding adjacent channel filtered power value from the assigned channel filtered power. The ACLR measurement page displays the four ACLR results for the Lower and Upper adjacent channels, as well as the filtered channel power for the assigned channel and the adjacent channels. ACLR values increase with improved signal leakage suppression, so larger positive values are better.

To measure ACLR:

1. Connect a signal to the YBT250 RF INPUT connector. See page 2-24 for connection instructions.
2. Select the Measure window (button 1).
3. Set the Signal Standard to the appropriate W-CDMA standard.

4. Tap **Select Measurement**.
5. Tap **ACLR**. See Figure 3-63.

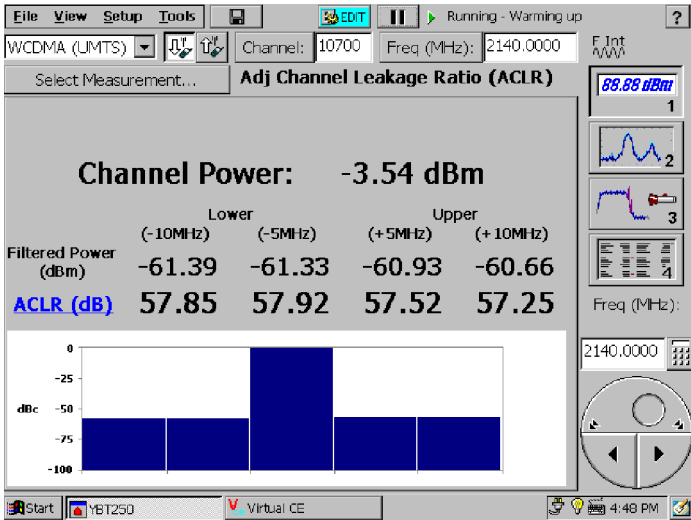

Figure 3-63: A typical ACLR display

Taking and Displaying Multiple Measurements at Once Using the Sequencer (Button 4)

On the Sequencer screen (tap button 4), you can view the current readouts for multiple measurements at the same time. These measurements include the numeric results that you could otherwise view one at a time on the Measurement screen (button 1). The YBT250 application sequences through each of the measurements that you designate and it summarizes the results on the Sequencer screen. See Figure 3-64.

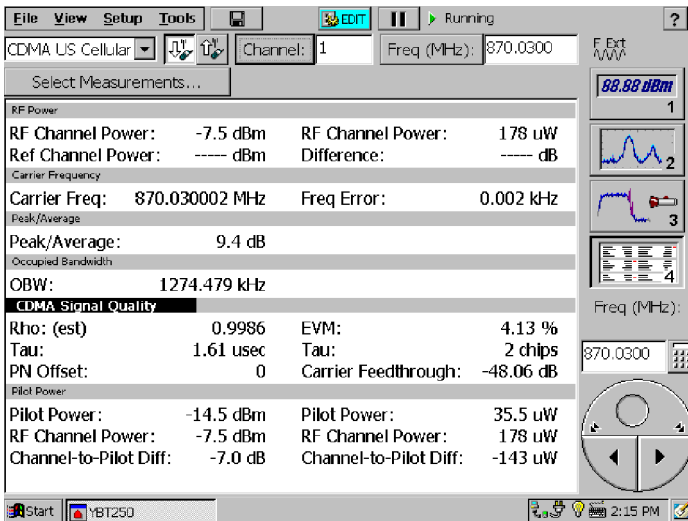

Figure 3-64: Sequencer display

To select which measurements to take and display on the Sequencer screen:

1. From the drop-down box, select the standard of interest.
2. Tap the Select Measurements button. The Select Measurements dialogue box appears. The list of measurements possible depends on the standard you selected.
3. Select or clear the measurements in the list to display only the measurements of interest to you.
4. Tap **OK**.

The Sequencer screen shows each measurement type you selected (such as RF Power and Carrier Frequency) in a gray bar. Beneath each measurement type, the measurement readouts are displayed. As each measurement type is updated, the measurement type heading is highlighted in reverse video. Any out-of-limit conditions are indicated by a red block with an up or down arrow. Messages may appear in the gray bar indicating any abnormal conditions.

You can save different sets of selected measurements for each standard and then recall these sequences later for reuse. To save a measurement sequence, tap **Setup > Save...**, enter a name, and tap **OK**.

You can use the file menu to save, export, or print the numeric Sequencer data, including error information and the timestamp (the time of the last individual measurement taken). Note that if you export a screen, a picture of only what shows on the screen will be exported. If there is a scroll bar visible, then some measurement results are hidden and are not exported. To avoid this problem, choose **Export Results As...**, or scroll down and export a second view of the screen.

Saving, Exporting, and Recalling Results, Traces, and Settings

The YBT250 Field Transmitter & Interference Tester can save measurement results and trace displays for later recall or for transfer to a PC. You can also set up the YBT250 for specific tests and save the setup to a file for later recall, saving you time when making measurements in the field.

Volatile memory is memory that loses data when power is removed. Non-volatile memory retains data when power is removed. When the YBT250 is powered off, any data stored in volatile memory is lost. Only data stored in non-volatile memory is retained when the YBT250 is powered off. On the YBT250, the **BuiltInDisk** folder is the only folder maintained in non-volatile memory.

When saving results, traces, or setups, be sure to save them in a folder located in the BuiltInDisk folder. When you start the application, the default folders for saving are as follows:

- The default folder for saved results is \BuiltInDisk\YBT250\AppData\Results.
- The default folder for saved traces is \BuiltInDisk\YBT250\AppData\Results.
- The default folder for saved setups is \BuiltInDisk\YBT250\AppData\Settings.



These locations are all located within the BuiltInDisk directory and so any data saved there is maintained after the YBT250 is powered down. Once you have saved a file, the default location will be whatever location you used most recently.

For auto saving spectrograms and codograms, you can change the default location only by selecting **Setup > Edit > Save & Export** tab and then changing the path in the **Codogram/Spectrogram Auto saves:** field. Your changes to this setting will persist when you next power-on the instrument.

Saving Measurement Results

The YBT250 enables you to save a measurement result to a file for later recall. Saving measurement results is meant for use in reproducing a Measure *display* on the YBT250 at a later time. Recalling a saved file allows you to use markers (if available for the measurement) to further analyze the result. When results are recalled, they appear in the display just as they did when saved. To use measurement *data* results in another program for analysis or generating a report, use the **Export Results** function; see page 3-127.

To save measurement results:

1. Take the measurement you want to save.
2. Select **File > Save Results As** (Save Results appears only when the Measure window is selected; Save Trace appears when the Spectrum and Interference windows are selected.).
3. Select the folder where you want to save the results.
4. Type a name for the file. Tap , in the taskbar, to display the soft keyboard. Tap  again to hide the keyboard when you are finished.
5. Tap **OK** to save the file.

What is Saved in a Measurement Results File

The following information is saved in the results file for each included measurement:

- Name of the measurement
- Measurement results and units
- Pass/fail status of the measurement (if limit testing is enabled)
- Time and date of the measurement

Additional information saved in a results file includes:

- Technician name
- User notes

- Setup information that is visible in the results display
- Error information (if errors were present)
- GPS coordinates (Refer to page 2-50 for GPS set up information.)

Recalling Measurement Results

You can recall saved measurement results for display. When saved measurement results are displayed, the display appears just as it did when the measurement was saved except for the status area of the control bar.

To recall measurement results for display:

1. Select **File > Open**.
2. Locate the directory that contains the measurement results file (the default is \BuiltInDisk\YBT250\AppData\Results).
3. Select the results file to recall and tap **OK**. See Figure 3-65.
4. To restart measurements, tap the Run button ()

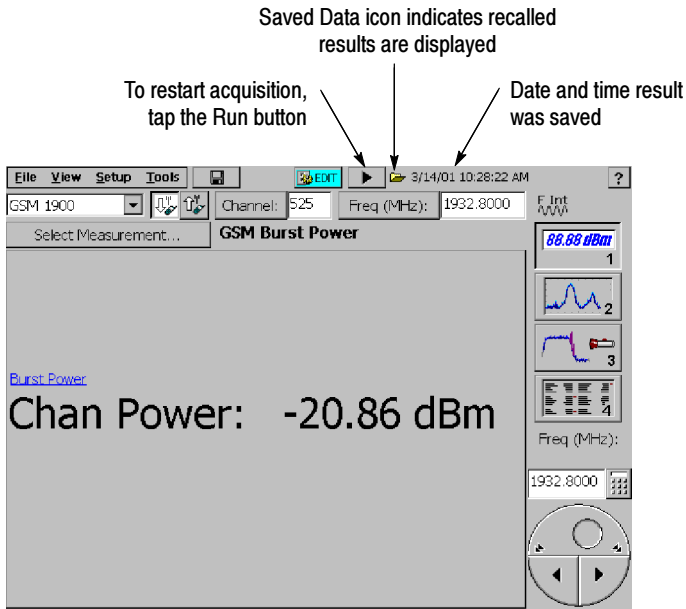

Figure 3-65: Example of a Recalled Result display

When a recalled measurements file is displayed, the Saved Data icon is displayed at the top of the screen, next to the time and date the file was saved.

You can view the various properties of the trace file by selecting File > Results Properties (see Figure 3-66).

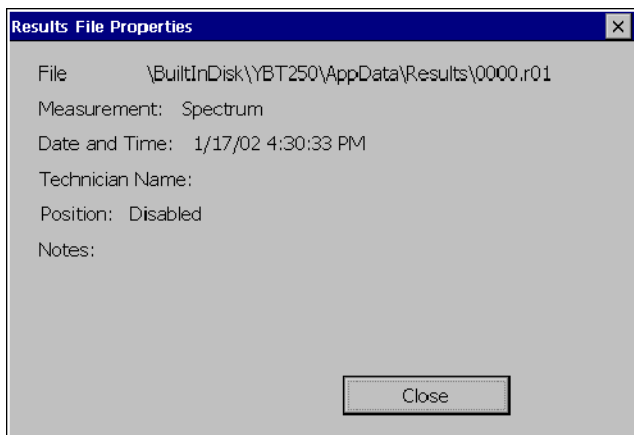

Figure 3-66: Results File Properties dialog box

Exporting Measurement Results

The YBT250 can save measurement results in a file for use in other applications, such as Microsoft Excel. The YBT250 exports files as tab-separated or comma-separated files. Files that use tabs to separate data fields are saved with a “txt” extension. Files that use commas to separate data fields are saved with a “csv” extension.

To export measurement results:



1. Select **File > Export Results**.
2. Select a file format from the Type list.
3. Type a name for the file. Tap , in the taskbar, to display the soft keyboard. Tap  again to hide the keyboard when you are finished.
4. Choose the location where the file should be saved.
5. Tap **OK** to save the file.

Figure 3-67 shows an exported results file.

| Name | Value | Units | Pass/Fail |
|-------------------------------|---------------------------|-------|-----------|
| Screen Name | RF Power | | |
| Signal Standard | CDMA US Cellular | | |
| Timestamp | 8/6/02 12:39:46 PM | | |
| Channel | 1 | | |
| Channel Forward/Reverse | Forward | | |
| Frequency (Hz) | 870030000 | | |
| Technician | Chiana | | |
| Notes for saved results | Main Array | | |
| Freq Ref | Internal | | |
| External Reference Frequency: | ---- | Hz | |
| Message | | | |
| GPS Position | 42 50 33.5S, 147 18 30.5E | | |
| Reference Channel | 3 | | |
| Mask Test Enable (idle) : | | False | |
| RF Channel Power: | -13.1 | dBm | |
| RF Channel Power: | 0.000049200 W | | |
| Ref Channel Power: | -13.3 | dBm | |
| Difference: | 0.2 | dB | |
| Message | | | |

Figure 3-67: Sample Exported Results file



NOTE. *The Technician name and User notes are entered from the Save & Export page of the Setup dialog; see page 2-45.*

Exporting a Screen

The YBT250 can export an image of the screen for use in other programs such as Microsoft Word. An exported screen is a graphic image of the YBT250 display. A screen can be saved in three formats: BMP, JPEG and PNG. An exported screen cannot be

displayed by the YBT250, it can be viewed only by a program that can display graphic images.

To export a screen image:

1. Select **File>Export Screen As...**
2. Select the image format from the **Type** list.
3. Type a name for the file. Tap , in the taskbar, to display the soft keyboard. Tap  again to hide the keyboard when you are finished.
4. Choose the location where the file should be saved.
5. Tap **OK** to save the file.



Saving a Trace

A saved trace contains an array of numbers that represent a displayed spectral graph. Saved traces are useful for sending to someone through email, recalling for later display, or printing a hardcopy at a later time. Saving a trace is identical to saving results, except that a trace or traces are included as part of the result.

To save a trace using an automatically generated filename:

- Select **File>Save Trace**.

To save a trace with a filename you enter:

1. Select **File>Save Trace As....**
2. Type a name for the file. Tap , in the taskbar, to display the soft keyboard. Tap  again to hide the keyboard when you are finished.
3. Choose the location where the file should be saved (the default is \BuiltInDisk\YBT250\AppData\Results).
4. Tap **OK** to save the trace.

Recalling a Trace

To recall a trace for display:

1. Select **File > Open**.
2. Locate the directory that contains the saved trace file (the default is \BuiltInDisk\YBT250\AppData\Results).
3. Select the trace file to recall and tap **OK**.

When a recalled trace is displayed, the Saved Data icon appears at the top of the display and the time and date the file was saved is also displayed. See Figure 3-68.

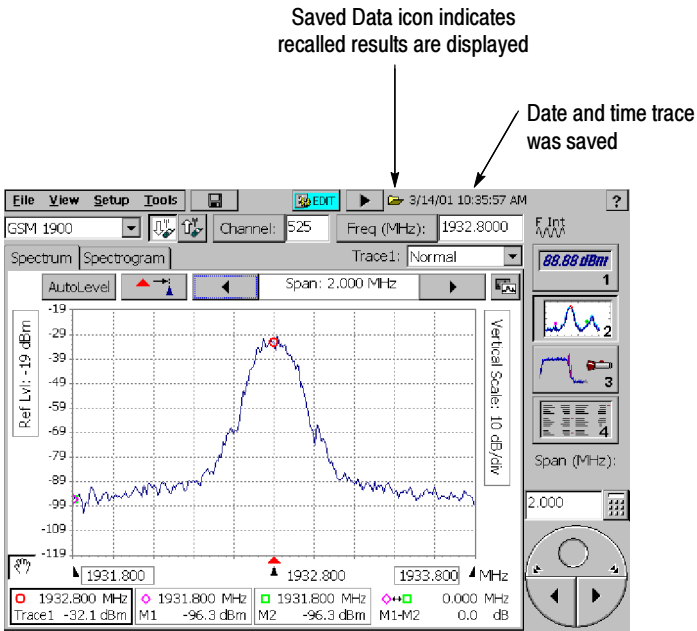



Figure 3-68: Example of a Recalled Trace display

Exporting a Trace

An exported trace is a text file that contains an array of numbers that represent a displayed trace. Exported traces are useful for analyzing with a spreadsheet program. Exported Traces can be saved with either tabs separating the data fields or commas separating the data fields. Exporting a trace is identical to exporting results, except that a trace or traces are included as part of the result.

To export a trace:

1. Select **File>Export Trace As....**
2. Type a name for the file. Tap , in the taskbar, to display the soft keyboard. Tap  again to hide the keyboard when you are finished.
3. Select the **Type** of file format, either tab-separated or comma-separated.
4. Choose the location where the file should be saved (the default is \BuiltInDisk\YBT250\AppData\Results).
5. Tap **OK** to save the trace.

Differences Between Exported Screens and Traces

Though an exported screen and an exported trace or results file might seem as though they are the same thing, they are significantly different. You can think of an exported screen as a kind of photograph of the YBT250 display. A saved or exported trace or results file contains information about the displayed signal.

When you restore and view a saved results or trace file, you can then export that result or trace file. Also, just as if the data were live, you can extract additional data from saved results or trace file on the YBT250 by using the measurement markers and cursors.

Table 3-11 shows the differences between an exported screen and a trace.

Table 3-11: Differences between exported screens and traces

| File type | Menu command | Read by other programs | File format |
|-----------------|---------------------|------------------------|-----------------------------|
| Exported Screen | Export Screen As... | Yes | BMP, JPEG PNG |
| Saved Trace | Save Trace | No | binary ¹ |
| | Save Trace As... | No | binary ¹ |
| Exported Trace | Export Trace As... | Yes | tab or comma-separated text |

¹Binary files can be read only by the YBT250

BMP is an uncompressed format and uses a lot of space, but maintains sharp images. JPEG is a compressed format and uses far less space than BMP, but can blur lines and text. PNG is a compressed format and maintains sharp lines and text. Table 3-12 compares the relative features of each of the export file formats.

Table 3-12: Comparison of file formats for exporting screens

| Format | Export speed | File Size | Quality |
|--------|--------------|-----------|-------------|
| BMP | Medium | Large | Very Good |
| JPEG | Very Slow | Medium | Medium/Poor |
| PNG | Fast | Small | Good |

An exported trace file contains information about the YBT250 settings and data that represents the trace. Figure 3-69 shows an example of an exported trace saved as a tab-separated text file. The numbers at the end (following “Trace 1 data”) represent the data points of the trace on the display. To save space, only a few numbers are shown in this example.

| Name | Value | Units | Pass/Fail |
|-------------------------------|--------------------|-------|-----------|
| Screen Name | Spectrum | | |
| Signal Standard | CDMA US Cellular | | |
| Timestamp | 8/6/02 12:41:13 PM | | |
| Channel | 1 | | |
| Channel Forward/Reverse | Forward | | |
| Frequency (Hz) | 870030000 | | |
| Technician | Aeryn Sun | | |
| Notes for saved results | | | |
| Freq Ref | Internal | | |
| External Reference Frequency: | ----- | Hz | |
| Message | | | |
| GPS Position | Disabled | | |
| Span (Hz) | 100000000 | | |
| Start Freq (Hz) | 820030000 | | |
| Stop Freq (Hz) | 920030000 | | |
| Reference Level (dBm) | 1 | | |
| dB/div | 10 | | |
| Trace 1 mode | Normal | | |
| Trace 2 On | True | | |
| Trace 2 Source | Live | | |
| Trace 2 Live mode | Normal | | |
| Mask Test Enabled | False | | |
| Mask Filename | | | |
| Mask Limit Test | Pass | | |
| Trace 1 data | Trace 2 data | | |
| -75.1 | -75.1 | | |
| -85.5 | -85.5 | | |
| -75.9 | -75.9 | | |
| -74.6 | -74.6 | | |
| | | | |
| -75.1 | -75.1 | | |

Figure 3-69: Example of an Exported Trace file



Saving Setups

The YBT250 can save its settings in Setup files for later recall. Recalling a saved setup changes the YBT250 settings to match those in the saved setup. Using saved setups minimizes your setup time in the field and helps to ensure more consistent measurement results. For example, you could save a setup for taking a Channel Power

measurement versus a specific Reference Channel. The saved setup will contain the channel numbers and limits as well as all other instrument control settings. Once the setup is saved, it can be copied to other YBT250 modules to save setup time in the field.

Saved setups contain all the settings included on the Setup pages (Setup > Edit or Edit button). Saved setups do not contain settings made under the Tools menu (such as Tools > Options). Options settings are persistent, but are not part of Saved Setups.

To save YBT250 setups:

1. Set all the YBT250 settings the way you want them.
2. Select **Setup > Save....**
3. Type a name for the file. Tap , in the taskbar, to display the soft keyboard. Tap  again to hide the keyboard when you are finished.
4. Choose the location where the file should be saved (the default is \BuiltInDisk\YBT250\AppData\Settings).
5. Tap **OK** to save the setup file.

Recalling Setups

Recalling a saved setup changes the YBT250 settings to match those in the saved setup file.

To recall setups:

1. To recall a setup, select **Setup > Open...**
2. Locate the directory that contains the setup file (the default is \BuiltInDisk\YBT250\AppData\Settings).
3. Select the setup file to recall and tap **OK**.

Customizing the Setup menu

The YBT250 allows you to customize the Setup menu to include a list of standard setups and to prevent accidental changes to existing setup files.

Preventing Changes to Saved Setups

The YBT250 enables you to hide setup controls so that accidental changes to saved setups cannot occur.

To hide setup controls:

1. Select **Tools>Options...** .
2. Select the **Setup Menu** tab. See Figure 3-70.

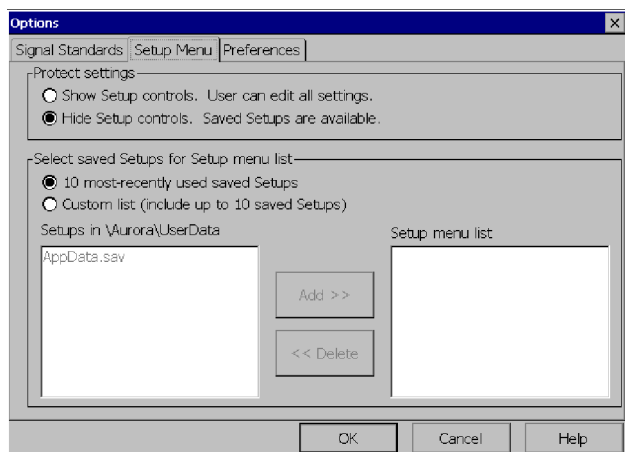



Figure 3-70: Protecting Setup Controls

3. To prevent a user from changing saved setups, select **Hide Setup controls**.
4. Tap **OK** to save the **Setup Menu** changes.

When **Hide Setup controls** is selected, tapping the **Edit** button () displays the Open dialog box instead of the Setup window. This allows the user to select a saved setup for recall, but not to edit any settings or save any setups. Additionally, when **Hide Setup controls** is selected, the **Setup > Edit** and **Setup > Save** menu items are disabled.

Enabling Changes to Saved Setups

If setup controls have been hidden, you cannot create new setup files. You must show setup controls so you can create new setup files.

To show setup controls:

1. Select **Tools>Options...** .
2. Select the **Setup Menu** tab. See Figure 3-70.
3. Select **Show Setup Controls**.

Once setup controls are visible, you can create new setup files.

Specifying the List of Saved Setups

The YBT250 enables you to specify the list of saved setups that appears in the Setup menu. You can choose to list either the 10 most recently used saved setups or display a custom list of setups. A custom list of saved setups provides consistent and quick access to a standard group of setup files.

To specify the list of setups in the Setup menu:

1. Copy or move all the setup files you want to listed in the Setup menu to the \BuiltInDisk\YBT250\AppData\Settings folder. The YBT250 will allow you to select only setups located in the \BuiltInDisk\YBT250\AppData\Settings folder for display in the Setup menu.
2. Select **Tools > Options...** .
3. Select the **Setup Menu** tab. See Figure 3-71.
4. To display the 10 most recently used saved setups in the Setup menu, select **10 most-recently used saved Setups**.

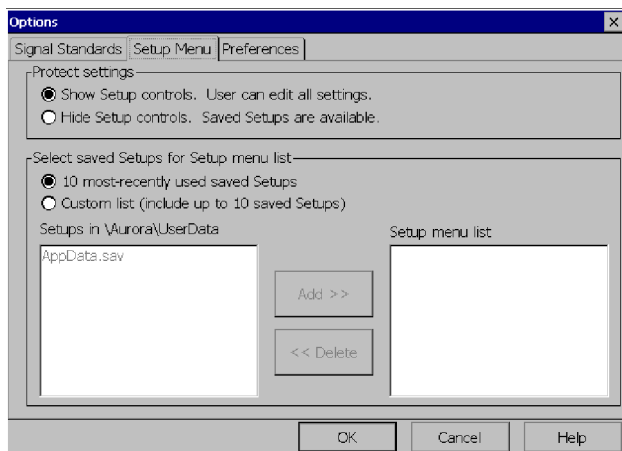

Figure 3-71: Specifying the List of Setups

5. To display only a selected list of saved setups, select **Custom List**.
 - a. Select a setup from the list on the left and tap **Add>>** to add the selected setup to the Setup menu.
 - b. Select additional setups until you have selected all the setups you want in the Setup menu. (You can select up to 10 setups to appear in the Setup menu.)

To remove a setup from the Setup menu list, select the setup to remove from the Setup menu List window and tap **<<Remove**.
6. Once you have selected all the setups you want listed in the Setup menu, tap **OK**.



Appendices

Appendix A: Specifications

This section lists the electrical, environmental, and physical specifications of the YBT250 Field Transmitter & Interference Tester. All specifications are guaranteed unless labeled “typical”. Typical specifications are provided for your convenience and are not guaranteed.

The specifications in this section apply to the YBT250 module, unless otherwise specified. For NetTek Analyzer Platform specifications, please refer to the NetTek Analyzer Platform User Manual.

Table A-1: General characteristics

| RF input characteristics | Description |
|---|---|
| Input Frequency Range | 30 MHz - 2500 MHz |
| Input Impedance | 50 ohms (nominal) |
| Signal Amplitude for Modulation Measurements | -50 dBm to +30 dBm for CW-like or peak envelope power Measurements may be outside this range but accuracy is not guaranteed. |
| Signal Amplitude for Spectral Display | CW or peak envelope power |
| Standard | -114 dBm to +30 dBm, 30 MHz to 2500 MHz |
| Option IN1 | -134 dBm to +30 dBm, 100 MHz to 2000 MHz -132 dBm to +30 dBm, 2000 MHz to 2200 MHz -129 dBm to +30 dBm, 2200 MHz to 2500 MHz, typical Levels apply only when using 100 kHz span (1 kHz resolution bandwidth) |
| Input Overload Detect | >1 W (+30 dBm) CW or peak envelope power |
| Maximum Input Power without Damaging Instrument | 50 W CW or peak envelope power |
| Coupling | AC for all measurements and spectral display modes |

Table A-1: General characteristics (Cont.)

| RF input characteristics | Description |
|---|--|
| Working Voltage | ≥ 15 V (DC + peak AC) |
| Spurious Input Signals | To meet modulation measurement specifications: (Total power of interest - Total power in spurious) > 35 dB or (Center frequency of signal of interest - center frequency of spurious signal) > 1.4 MHz and (Total power of interest - Total power in all spurious) ≥ -3 dB |
| External Reference Input Characteristics | Description |
| Impedance | 50 ohms (nominal) |
| Frequency Range | Any multiple of 1 MHz up to 15 MHz inclusive, ± 10 ppm Any multiple of 1.2288 MHz up to 19.6608 MHz inclusive, ± 10 ppm 2.048 MHz ± 10 ppm 4.8 MHz ± 10 ppm |
| Level Range | -15 dBm to +15 dBm |
| Maximum Input Level without Damage Instrument | ± 3 V peak continuous |
| Coupling | AC |
| Working Voltage | 3 V (DC + pk. AC) |
| Lock Time | < 15 seconds |
| Even Second Clock Input Characteristics | Description |
| Impedance | 10 k Ω |
| Minimum High Threshold | 2.0 V |

Table A-1: General characteristics (Cont.)

| Even Second Clock Input Characteristics | Description |
|--|---|
| Maximum Low Threshold | 0.8 V |
| Minimum High Time | ≤ 10 ns |
| Minimum Low Time | ≤ 10 ns |
| Maximum Input Level without Damage | ± 5 V peak continuous |
| Coupling | DC |
| Frequency Lock Range | ± 10 ppm |
| Internal Time Base Characteristics | Description |
| Error | <p>± 0.5 ppm drift from 0 °C to 50 °C</p> <p>± 1.0 ppm aging/year</p> <p>Ten minute warm-up period required to meet accuracy specification.</p> <p>Users can connect the External Reference input to a frequency source and obtain a user correction value. This value will be used to correct time base errors in measurements to the accuracy of the external reference. The internal time base will continue to drift with temperature and age as specified above.</p> |
| Signal Path Characteristics | Description |
| Phase Noise | ≤ -70 dBc/Hz @ 20 kHz carrier offset |

Table A-2: Measurement characteristics

| Measurement | Description |
|----------------------|--|
| Standards Supported | See Table F-1 on page F-1. |
| External Attenuation | User Selectable ON/OFF Attenuation = -30 dB to +80 dB |

Table A-2: Measurement characteristics (Cont.)

| Measurement | Description |
|---------------------|---|
| RF Channel Power | Measures the average RF power in a user-defined channel. The default value of channel bandwidth is taken from the selected standard. The acceptable values for channel numbers are taken from the selected standard. The user can input channel center frequency instead of channel number. |
| Units | Watts (W) dBm |
| Resolution | 3 significant digits for W 0.1 dB for dBm units |
| Accuracy | ± 0.75 dB: -20 dBm to +30 dBm, ± 0.5 dB typical ± 1.25 dB: -80 dBm to -20 dBm, ± 1.0 dB typical Reference Information: Accuracy is guaranteed for input signals between -80 and +30 dBm total power (CW or peak envelope). Accuracy specification is typical down to -120 dBm total power. |
| RF Power (GSM/EDGE) | Measures the average RF power of the useful part of a GSM or EDGE burst (GMSK or 8-PSK modulation), as determined by the location of the burst Training Sequence. |
| Units | dBm |
| Resolution | 0.01 dB for dBm units |
| Accuracy | For GSM or EDGE (GMSK or 8-PSK modulation) burst signals, the RF power shall be measured with an accuracy as follows: ± 1.0 dB: -20 dBm to +30 dBm, ± 0.75 dB typical ± 1.5 dB: -80 dBm to -20 dBm, ± 1.25 dB typical |

Table A-2: Measurement characteristics (Cont.)

| Measurement | Description |
|------------------------------|--|
| | Reference Information: Burst timing is determined from the location of the burst Training Sequence. If Burst timing cannot be found, the power measurement will be done on an arbitrarily selected segment of the signal equal to the useful part of a slot. |
| RF Power (1xEV-DO) | Measures the RF power in the Pilot, MAC, and Data intervals of a 1xEV-DO timeslot. |
| Units | dBm |
| Resolution | 0.01 for dBm units |
| Accuracy | For burst signals, the RF power shall be measured with an accuracy as set forth in the following list: ± 1.0 dB: -20 dBm to +30 dBm, ± 0.75 dB typical ± 1.5 dB: -80 dBm to -20 dBm, ± 1.25 dB typical |
| RF Channel Carrier Frequency | Measures the frequency of the carrier in the user selected channel. The user can enter either a channel number or frequency. |
| Units | MegaHertz (MHz) |
| Resolution | 1 Hz |
| Accuracy | ± (10 Hz + Time Base Error), 99% confidence interval W-CDMA: ± (12 Hz + Time Base Error), 99% confidence interval Note: Carrier frequency must be within 10 kHz of expected value, except: W-CDMA: Must be within 5 kHz IS-136: Must be within 1.5 kHz 1xEV-DO: Must be within 5 kHz GSM/EDGE: Must be within 5 kHz W-CDMA 3GPP Test Model 4 |

Table A-2: Measurement characteristics (Cont.)

| Measurement | Description |
|----------------------------------|---|
| FM Deviation | Measures the maximum one-side frequency deviation of the analog FM cellular carrier selected by the user after demodulation. The user can enter either a channel number or frequency. |
| Units | KiloHertz (kHz) |
| Resolution | 0.1 kHz |
| Accuracy | $\pm 10\%$ $2 \text{ kHz} \leq \text{Deviation} \leq 10 \text{ kHz}$ Maximum measurable deviation is 15 kHz peak. Maximum modulation frequency is 3 kHz. |
| PN Offset | Measures the PN Offset of the cdmaOne or cdma2000-1x signal. The user can select the CDMA signal of interest by a channel number or frequency. |
| Units | PN Index |
| Resolution | 1 PN Index Each PN Index is 64 chips |
| Accuracy | Displayed PN Index must match PN Offset of CDMA signal. |
| Pilot Time Alignment Error (Tau) | Measures the time offset between the PN sequence of the input signal and the External Even Second Clock. |
| Units | Microsecond (μs) Chips |
| Resolution | 0.1 μs 1 chip |
| Accuracy | $\pm 250 \text{ ns}$ typical |

Table A-2: Measurement characteristics (Cont.)

| Measurement | Description |
|---------------------------------|---|
| Waveform Quality (Rho, ρ) | <p>Measures waveform quality as defined by IS-97-D using a “pilot-only” CDMA (or cdma2000-1x) signal.</p> <p>cdmaOne and cdma2000: Measures waveform quality as defined by IS-97-D using a “pilot-only” CDMA (or cdma2000-1x) signal.</p> <p>1xEV-DO: Measures Rho-pilot as defined by C.S0032 “Minimum Performance Standards for HRPD Access Network”</p> |
| Units | None |
| Resolution | 0.0001 |
| Accuracy | <p>± 0.005 $0.9 \geq \rho \geq 1.0$</p> <p>Usable range $0.5 \geq \rho \geq 1.0$</p> <p>Reference Information:</p> <p>For cdmaOne and cdma2000, the Rho measurement as given in IS-97-D is only specified for a “pilot-only” CDMA signal. The accuracy specification given here applies only to measurements made using the “Pilot only, no other codes active on input signal” method. For measurements made on signal that are not “pilot-only,” see the Estimated Waveform Quality measurement.</p> <p>For measurements made on signal that are not “pilot-only”, see the Estimated Waveform Quality measurement.</p> |

Table A-2: Measurement characteristics (Cont.)

| Measurement | Description |
|-----------------------------|--|
| Estimated Waveform Quality | Measures waveform quality as defined by IS-97-D using any CDMA signal. |
| Units | None |
| Resolution | 0.0001 |
| Accuracy | <p>± 0.01 for $\rho \geq 0.9$, typical</p> <p>Reference Information: The Rho measurement as given in IS-97-D is only specified for a "pilot-only" CDMA signal. This measurement makes an estimate of the Rho value on any CDMA signal.</p> |
| CDMA Error Vector Magnitude | The normalized RMS of all of the vectors that extend from the intended constellation points to the actual symbol points in a record of symbols |
| Units | Percent |
| Resolution | 0.01% |
| Accuracy | <p>Degradation due to adjacent channel CDMA carriers (having equivalent power): add 10%.</p> <p>cdmaOne and cdma2000:</p> <p>$\pm 1\%$; $EVM \leq 31\%$</p> <p>Residual error:</p> <p>5% < 1000 MHz</p> <p>7% < 2000 MHz</p> <hr/> <p>W-CDMA:</p> <p>$\pm 2.5\%$; $12.5\% \leq EVM \leq 22.5\%$</p> <p>Residual error:</p> <p>6% < 1000 MHz</p> <p>8% < 2500 MHz</p> |

Table A-2: Measurement characteristics (Cont.)

| Measurement | Description |
|-------------------|--|
| | <p>Reference Information:</p> <p>The EVM measurement differs from the traditional method in that it is normalized by the average power rather than by maximum constellation power. This measurement is accurate for both pilot-only and in-service CDMA signals.</p> <p>W-CDMA 3GPP Test Model 4</p> |
| Code Domain Power | Measures the power in each of the Walsh codes used in a CDMA signal. |
| Units | <p>dB relative to Pilot Power (except 1xEV-DO)</p> <p>dB relative to Total Power</p> |
| Resolution | <p>0.1 dB (all except 1xEV-DO Data CDP)</p> <p>0.01 dB (1xEV-DO Data CDP)</p> |
| Accuracy | <p>cdmaOne and cdma2000: ± 1 dB Code domain power level > -20 dB relative to total power, using the recommended TIA/EIA-IS-97-D pilot level of -7.0 dB (20%) relative to total power.</p> <p>W-CDMA: ± 1 dB Code domain power level > -20 dB relative to total power, using W-CDMA 3GPP Test Model 3.</p> <p>1xEV-DO: MAC: ± 1 dB code domain power level > -20 dB relative to total power in MAC interval Data: ± 0.5 dB for non-idle slot data</p> <p>Reference Information: ± 2.5 dB for -27 dB $< \text{CDP} < -20$ dB relative to total power (band classes 0-9 for cdmaOne, cdma2000 and 1xEV-DO)</p> |

Table A-2: Measurement characteristics (Cont.)

| Measurement | Description |
|---------------------|---|
| Carrier Feedthrough | Measures the offset of the constellation from zero power. |
| Units | dB relative to Pilot Power (all except 1xEV-DO) |
| Resolution | 0.1 dB |
| Accuracy | cdmaOne and cdma2000: ± 2 dB Residual floor: -50 dBc Reference Information: For cdmaOne and cdma2000, the carrier feedthrough measurement is valid only for a pilot-only signal. |
| Pilot Power | Measures the absolute power of the pilot. It is made without regard to whether other codes are present. (P-CPICH for W-CDMA.) |
| Units | dBm, Watts (W) |
| Resolution | 0.1 dB |
| Accuracy | ± 1 dB, -20 dBm to +30 dBm ± 1.5 dB, -50 dBm to -20 dBm Reference Information: W-CDMA 3GPP Test Model 2 |
| Sync Power | Measures the absolute power of the W-CDMA sync channel (SCH). It is made without regard to whether other codes are present. |
| Units | dBm, Watts (W) |
| Resolution | 0.1 dB |

Table A-2: Measurement characteristics (Cont.)

| Measurement | Description |
|--|--|
| Occupied Bandwidth | The occupied bandwidth measurement gives the frequency bandwidth within which 99% of the power transmitted on a single channel lies. This measurement can be properly made only if the channel being measured has no channels adjacent to it. |
| Units | Hertz (Hz) |
| Resolution | Three significant digits |
| Accuracy | 5% of the reading, typical |
| Adjacent Channel Leakage power Ratio (ACLR) (W-CDMA) | Measures the ratios of the mean RRC filtered power in the 5 MHz BW assigned channel to the mean RRC filtered power in each of the nearest 5 MHz BW 1st and 2nd adjacent upper and lower channels. Adjacent channel centers are offset in multiples of 5 MHz from the assigned channel center. User can input channel center frequency instead of channel number. |
| Units | dB |
| Resolution | 0.01 dB |
| Accuracy | ± 1.5 dB, $20 \leq \text{ACLR} < 48$ dB, typical ± 2.5 dB, $48 \leq \text{ACLR} < 53$ dB, typical -30 dBm to +20 dBm (power in assigned channel) |
| | Reference Information: WCDMA Test Model 1 signal (3G PP TS25.141). Filter response is Root-Raised Cosine (RRC), $\alpha=0.22$, 3.84 MHz noise BW (3GPP TS25.104). |
| GSM/EDGE Error Vector Magnitude | Error Vector Magnitude is the normalized RMS value of all of the vectors that extend from the intended constellation points to the actual symbol points in a record of symbols. The EVM measurement is made over one GSM or EDGE burst. |
| Units | Percent |
| Resolution | 0.01% |
| Accuracy (8-PSK only) | $\pm 1.5\%$, $4\% \leq \text{EVM} < 10\%$ Residual error: 4.0% |

Table A-2: Measurement characteristics (Cont.)

| Measurement | Description |
|--|---|
| GSM/EDGE Phase Error | Phase Error is the RMS value of the differences between the phase angles of the received signal and those of an ideal reconstructed signal. The Phase Error measurement is made over one GSM or EDGE burst. |
| Units | Degrees |
| Resolution | 0.01° |
| Accuracy (GMSK only) | ± 1.0°, 2° ≤ Phase Error < 12° Residual error: 2.0° |
| GSM/EDGE Origin Offset | Origin Offset is the ratio of unmodulated signal power to modulated signal power. The unmodulated signal component causes the signal constellation center to be offset from the ideal location. The Origin Offset measurement is made over one GSM or EDGE burst. |
| Units | dB |
| Resolution | 0.01 dB |
| Range | -15 dB to -60 dB |
| GSM/EDGE Carrier to Interference (C/I) | Carrier to Interference (C/I) is the ratio of desired signal (carrier) to undesired signal (interference). The C/I measurement is derived from the EVM result and gives an estimate of the power-based C/I value. The C/I measurement is made over one GSM or EDGE burst. |
| Units | dB |
| Resolution | 0.01 dB |
| Range | 0 dB to 50 dB |
| | Reference Information: C/I is derived from EVM using the following equation: $C/I = -20 * \log_{10}(EVM/100)$ |

Table A-2: Measurement characteristics (Cont.)

| Measurement | Description |
|---------------------------|--|
| GSM/EDGE RF Power vs Time | Power vs Time displays the normalized signal envelope power over one GSM or EDGE burst. |
| Units | Time Axis: Symbols Microseconds |
| Resolution | Time Axis: 1 symbol 1 microsecond |
| Time uncertainty | ± 0.2 symbol ± 0.8 microsecond |
| | Reference Information: Burst to mask alignment is derived from the location of the Training Sequence in the useful part of the burst. |

Table A-3: Spectral analysis characteristics

| Characteristic | Description |
|-----------------------|---|
| Measurement Frequency | Sets the measurement frequency of the display. The measurement frequency can be set by either entering a specific frequency or by selecting a channel number. |
| Units | MegaHertz (MHz) Channel Number |
| Resolution | 1 kHz 1 channel |
| Range | 30 MHz to 2500 MHz |

Table A-3: Spectral analysis characteristics (Cont.)

| Characteristic | Description |
|----------------------------|---|
| Frequency Span | Sets the frequency range covered by the spectral display. |
| Units | KiloHertz (kHz) MegaHertz (MHz) |
| Resolution | 1 kHz |
| Range | 10 kHz to 2470 MHz, continuously variable or 1-2-5 steps |
| Resolution Bandwidth (RBW) | Width of the resolution bandwidth filter |
| Units | Hertz (Hz) KiloHertz (kHz) MegaHertz (MHz) |
| Resolution | Uses 1-3 steps to cover the range |
| Range | 100 Hz to 6 MHz Instrument automatically sets RBW. The RBW is set as a combination of 1-3 steps at the 1, 2, 5 span settings, and a linear range between 1, 2, 5 span settings, for a nominal value of approximately Span/125. |
| Reference Level | The power level indicated by the top line of the spectral display |
| Units | dBm |
| Resolution | 1 dB |
| Range | -100 dBm to +30 dBm |

Table A-3: Spectral analysis characteristics (Cont.)

| Characteristic | Description |
|----------------------------|---|
| Spectral Display Amplitude | |
| Units | dB relative to Reference Level |
| Resolution | 0.1 dB |
| Range | 100 Hz to 1 MHz |
| Accuracy | |
| Standard | ± 1.25 dB, -20 dBm to +30 dBm ± 2.0 dB, -80 dBm to -20 dBm ± 2.75 dB, -104 dBm to -80 dBm |
| Option IN1 | ± 1.25 dB, -20 dBm to +30 dBm ± 2.0 dB, -80 dBm to -20 dBm ± 2.75 dB, -120 dBm to -80 dBm |
| | <p>Reference Information (applies to Standard and Option IN1 Accuracy):</p> <p>Spectral display accuracy performance is specified over the following range:</p> ± 5 dB -134 dBm < Input < -120 dBm <p>Accuracy specs apply only for spans less than 1000 MHz, and to CW-like signals</p> <p>The amplitude accuracy for Noise-like signals is degraded when averaging is turned on. This is approximately a 2.5 dB degradation due to the averaging being done after the logging instead of before. Any accuracy for noise-like signals using a marker will be impacted greatly by the user not necessarily knowing the effective IF noise bandwidth, and less so by this error. Therefore it is recommended that the user utilize power measurement routines instead of markers for any noise-like signals.</p> |

Table A-3: Spectral analysis characteristics (Cont.)

| Characteristic | Description |
|-----------------------|--|
| Vertical Scale Factor | |
| Units | 1 dB to 10 dB in 1 dB increments |
| Display Modes | <p>Normal - updates display with each new result</p> <p>Max Hold - updates displayed point only if new point > old point</p> <p>Min Hold - updates displayed point only if new point < old point</p> <p>Max/Min Hold - displays a bar between Max Hold and Min Hold</p> <p>Average - displays average of N (specified by user) results</p> <p>Reference Information:</p> <p>Average is calculated as follows - The last N values are saved in memory; when a new result is available, the earliest result of the N stored values is discarded, the new average is calculated from the stored values. If the number of results is less than N, then all of the results are averaged together.</p> |
| Number of Averages | $1 \leq N \leq 99$ |

Table A-3: Spectral analysis characteristics (Cont.)

| Characteristic | Description |
|---|---|
| Spurious Free Dynamic Range (external signal related) | > 70 dB, except 2 nd harmonic > 60 dB typical |
| Residual Spurious Signals | <p>-125 dBm at BTS Rx frequencies (776-794, 806-849, 872-940, 1453-1465, 1525-1549, 1710-1785, 1840-1910, 1920-1980) MHz and GPS frequencies (L1 1570.3 - 1580.5, L2 1222.5-1232.8, L5 1171.4-1181.6) MHz</p> <p>-115 dBm at BTS Tx frequencies (746-764, 832-834, 840-960, 1477-1513, 1805-1880, 1930-1990, 2110-2170) MHz</p> <p>-95 dBm at frequencies not listed above, except from 1155 to 1168 MHz: -20 dBm in spans above 10 MHz, 1155 MHz to 1175 MHz</p> |

Table A-4: Interference analysis characteristics

| Characteristic | Description |
|---------------------------|---|
| Modulation Identification | Attempts to display the type of modulation present on a signal identified by the user. |
| Input Signal Level | <p>-114 dBm minimum for all signal types</p> <p>+30 dBm maximum for CW or peak envelope power</p> |
| Carrier Frequency | See RF Carrier Frequency on page A-5 for specifications |
| Power in Bandwidth | See RF Channel Power on page A-4 for specifications |
| Modulation Type | The types of modulation identified are those listed in Appendix <i>Signal Standards Supported</i> . |

Table A-4: Interference analysis characteristics (Cont.)

| Characteristic | Description |
|-------------------------|---|
| Noise Floor Measurement | Measures the interference power that is coming into the receiver antenna for any standard. Measurement defaults to uplink channel when specified by channel number. |
| Units | dBm |
| Resolution | 0.1 dB |
| Accuracy | ± 3 dB typical |
| AM Demodulation | Provides an audio output signal after AM demodulation of the user-selected signal |
| Measurement Frequency | 30 MHz to 2500 MHz with 1 kHz resolution |
| Input Signal Level | -100 dBm minimum |
| Measurement Bandwidth | 8 kHz |
| Audio Output Bandwidth | 4 kHz |
| Run Time | 4 seconds per activation |

Table A-4: Interference analysis characteristics (Cont.)

| Characteristic | Description |
|---------------------------------|---|
| FM Demodulation | Provides an audio output signal after FM demodulation of the user-selected signal |
| Measurement Frequency | 30 MHz to 2500 MHz with 1 kHz resolution |
| Input Signal Level | -100 dBm minimum |
| Maximum Signal Deviation | Up to 100 kHz |
| Measurement Bandwidth | 8 kHz, 15 kHz, 75 kHz, 200 kHz; Selected by user |
| Audio Output Bandwidth | 4 kHz for Measurement BW = 8 kHz, 15 kHz 15 kHz for Measurement BW = 75 kHz, 200 kHz |
| Run Time | 4 seconds per activation |
| Signal Strength Indicator | Provides an audio tone and a visual display that vary with the strength of the selected signal |
| Input Signal Level | -110 dBm minimum >-60 dB, from any other signal |
| Measurement Frequency | 30 MHz to 2500 MHz with 1 kHz resolution |
| Measurement Bandwidth | Up to 10 MHz, dependent on span setting |
| Span | 1 kHz to 100 MHz with 1 kHz resolution |
| Signal Strength Indicator Range | >-60 dB from Reference Level setting |
| Tone Type | Variable Beep Rate, based on signal strength Variable Frequency, based on signal strength |

Table A-4: Interference analysis characteristics (Cont.)

| Characteristic | Description |
|---------------------------------|---|
| W-CDMA Scrambling Code Analyzer | Detects scrambling codes and pilot channel power levels of received co-channel W-CDMA downlink signals |
| Input Signal Range | -117 to +30 dBm, typical |
| Units | Io, Ec - dBm Ec/Io - dB |
| Resolution | 0.1 dB |
| Accuracy | Ec: ±2 dB for Ec ≥ -102 dBm and Ec/Io ≥ -12 dB, typical ±3 dB for Ec ≥ -112 dBm and Ec/Io ≥ -14 dB, typical |
| Display Controls | Sort by Power (descending Ec value) Sort by Scrambling Code (ascending SC index) Lock (fix) current Scrambling Code set |

Table A-5: Environmental characteristics

| Characteristic | Description |
|-------------------|---|
| Temperature Range | |
| Operating | 0 °C to +50 °C specified performance, -10 °C to +50 °C typical |
| Nonoperating | -40 °C to +60 °C |
| Humidity | |
| Operating | 5% to 95% Relative Humidity (RH), noncondensing: up to +30 °C 5% to 45% Relative Humidity (RH), noncondensing: +30 °C up to +50 °C |
| Nonoperating | 5% to 95% Relative Humidity (RH), noncondensing: up to +30 °C 5% to 45% Relative Humidity (RH), noncondensing: +30 °C up to +50 °C |
| Altitude | |
| Operating | Up to 4,600 m (15,092 ft.) |
| Nonoperating | Up to 15,240 m (50,000 ft.) |

Table A-6: Physical characteristics

| Characteristic | Description |
|----------------|--|
| Dimensions | Height: 25 cm. (9.75 in) Width: 33 cm. (13 in) Depth: 9 cm. (3.5 in) |
| Weight | 1.42 kg (3.125 lbs), YBT250 module only 4.10 kg (9 lbs), NetTek Analyzer Platform only, with one battery |

Table A-7: Miscellaneous characteristics

| Characteristic | Description |
|----------------------------------|---|
| Battery Life | |
| One battery installed | 2 hours with measurements active 4 hours in suspend mode |
| Two batteries installed | 4 hours with measurements active 8 hours in suspend mode |
| Recommended Calibration Interval | 2 years |

Table A-8: Safety compliance

| Category | Standards or description |
|-------------------|---|
| Safety Compliance | ANSI/ISA S82.02.01 Safety Standard for Electrical and Electronic Test, Measuring, Controlling, and Related Equipment. CAN/CSA C22.2 No. 1010.1 Safety Requirements for Electrical Equipment for Measurement, Control, and Laboratory Use. EN 61010-1 Safety Requirements for Electrical Equipment for Measurement, Control, and Laboratory Use. IEC61010-1 Safety Requirements for Electrical Equipment for Measurement, Control, and Laboratory Use. UL3111-1 Standard for Electrical Measuring and Test Equipment. |

Table A-9: Electromagnetic compatibility (EMC)

| Category | Standards or description |
|---|---|
| EC Declaration of Conformity - EMC | <p>Meets the intent of Directive 89/336/EEC for Electromagnetic Compatibility. Compliances were demonstrated using EN 61326:1997 EMC Product Family Standard for Electrical Equipment for Measurement, Control and Laboratory use.</p> <p>Emissions¹</p> <p>EN 61326² Class A Radiated and Conducted Emissions EN 61000-3-2 (A14) Conducted Power Line Harmonic Current EN 61000-3-3 Voltage Changes, Fluctuations, and Flicker.</p> <p>Immunity^{1,3}</p> <p>IEC 61000-4-2 Electrostatic Discharge Immunity, Performance Criterion "B" IEC 61000-4-3⁴ Radiated RF Electromagnetic Field Immunity, Performance Criterion "A" IEC 61000-4-4 Electrical Fast Transient/Burst Immunity Performance Criterion "B" IEC 61000-4-5 Power Line Surge Immunity, Performance Criterion "B" IEC 61000-4-6⁴ Conducted RF Immunity, Performance Criterion "A" IEC 61000-4-11 Voltage Dips and Short Interruptions Immunity, Performance Criterion "B"</p> |
| Australia/New Zealand Declaration of Conformity - EMC | <p>Complies with EMC Framework and demonstrated per Emission standard:</p> <p>AS/NZS 2064 Industrial, Scientific, and Medical Equipment</p> |

¹ Compliance demonstrated using high quality, shielded interface cables.

² Emissions that exceed the limits of the standard may occur when the instrument is connected to a device under test.

³ Minimum immunity test requirement.

⁴ Residual spurious signals can increase to -70 dBm with exposure to the disturbance levels of this test.

Appendix B: Accessories

This section lists the YBT250 Field Transmitter & Interference Tester standard and optional accessories.

Standard Accessories

Table B-1 lists the accessories that come standard with your YBT250 Field Transmitter & Interference Tester.

Table B-1: Standard accessories

| Quantity | Part number | Description |
|----------|-------------|---|
| 2 | 200-0678-00 | BNC Connector Cover |
| 1 | 200-4696-00 | N Connector Cover |
| 1 | 016-1868-00 | Spacer |
| 1 | 020-2464-XX | User manual, English, with CD-ROM containing YBT250 Field Transmitter & Interference Tester software and User Manual in PDF format. |

Optional Accessories

Table B-2 lists optional accessories you can purchase for your YBT250 Field Transmitter & Interference Tester. Contact your Tektronix representative or distributor for ordering information. See page xv for further information on contacting Tektronix.

Table B-2: Optional accessories

| Part number | Description |
|-------------|---|
| 012-0114-00 | Low-precision "N" 6 foot cable (1.83 m) |
| 012-0482-00 | RF Coaxial Cable, 50 Ohm, 36 inch (91 cm), BNC Male to BNC Male |
| 012-1619-00 | Calibrated precision "N" 10 Foot Cable |
| 103-0045-00 | "N" Male to BNC Female Adapter |
| 103-0429-00 | Barrell "N" Female |
| 103-0430-00 | "N" Male to "N" Male Adapter, DC-18 GHz |
| 103-0431-00 | 7-16(F) to N(F) Adapter |
| 103-0432-00 | 7-16(M) to N(F) Adapter |
| 119-6594-00 | Beam Antenna 824 MHz - 896 MHz |
| 119-6595-00 | Beam Antenna 896 MHz - 960 MHz |
| 119-6596-00 | Beam Antenna 1710 MHz - 1880 MHz |
| 119-6597-00 | Beam Antenna 1850 MHz - 1990 MHz |
| 119-6598-00 | DC Block Type N |
| 119-6599-00 | N(F) to N(M) Attenuator 50 W, 20 dB |
| 119-6600-00 | Calibrated Coupler "N" 500 MHz -1000 MHz |
| 119-6601-00 | Directional Coupler "N" 920 MHz -2200 MHz |
| 119-6602-00 | Universal Adapter Kit, 30 pcs |
| 119-6609-00 | Sniffer Antenna |
| 174-3578-00 | SMB Female to BNC Male |

Table B-2: Optional accessories (Cont.)

| Part number | Description |
|--------------------|--------------------|
| 200-0678-00 | BNC Metal Cap |
| 200-4696-00 | “N” Metal Cap |

For the most current list of accessories, please see the Tektronix website: www.tektronix.com.

Appendix C: Options

This section lists the configuration and measurement options available for the YBT250. To take RF measurements, interference measurements or modulation measurements, a measurement option must be installed in the YBT250. You can order one measurement option, all the available options, or any combination of options. You can add a measurement option to your YBT250 without returning it to Tektronix. For information on installing a measurement option on your YBT250, see Appendix D.

Table C-1 lists the measurement options available for the YBT250 Field Transmitter & Interference Tester.

Table C-1: Measurement options

| Option | Description |
|------------|---|
| Option EM1 | Add RF measurements for GSM/EDGE standards |
| Option GR1 | Add RF measurements for GSM standards |
| Option CR1 | Add RF measurements for cdmaOne/cdma2000 standards |
| Option CD1 | Add Demodulation measurements for cdmaOne standards |
| Option CD2 | Add Demodulation measurements for cdma2000 standards |
| Option IR1 | Add RF measurements for IS-136 standards |
| Option AR1 | Add RF measurements for Analog standards |
| Option IN1 | Add Interference measurements standards |
| Option WS1 | Adds analysis of W-CDMA Scrambling Code, including a Scrambling Code display and Ec/Io and Ec data. |
| Option WR1 | Add RF measurements for W-CDMA |
| Option WD1 | Add Demodulation measurements for W-CDMA |

Table C-1: Measurement options (Cont.)

| Option | Description |
|---------------|---|
| Option CRE | Add RF measurements for CDMA2000 1x EV-DO standards |
| Option CDE | Add Demodulation measurements for CDMA2000 1x EV-DO standards |

Appendix D: Installing Options and Upgrading Software

The YBT250 Field Transmitter & Interference Tester is a highly-configurable instrument. You can buy the YBT250 with only the measurement capability you need and then add measurement capabilities as your needs expand. Additional measurement capability is added by enabling or installing software options. The available measurement options are shown in Table C-1 on page C-1.

Measurement options are enabled by entering an Options key. An Options key is a coded text string that is tied to the serial number and Global ID of the instrument module. An Options key works only on the YBT250 for which it is purchased. To purchase an Options key, contact your local Tektronix representative.

Before Installing Options

You can install the measurement options listed in Table C-1 without returning the YBT250 to Tektronix. First, you will need to purchase a new Options key from Tektronix. To purchase a new Options key you will need to provide the serial number and Global ID for your YBT250 module (not the NetTek Analyzer Platform).

To display the YBT250 serial number:

- From the YBT250 application menu bar, select **Tools > Hardware info.**

The serial number is displayed near the top of the window. The serial number is also printed on a tag located on the bottom of the module.

To display the YBT250 Global ID:

- From the YBT250 application menu bar, select **Tools > Hardware info.**

The Global ID is displayed at the bottom of the scrolling window.

To reinstall the original application software or install a free upgrade on the YBT250, you will need the current Options key for your YBT250.

To display the YBT250's current Options key:

- From the YBT250 application menu bar, select **Tools > Software info**.

The Options key is displayed near the bottom of the scrolling window.

Installing Options

To install an option once you have an Options key:

1. Power on the NetTek Analyzer Platform.
2. From the YBT250 application menu bar, select **Tools > Upgrade Software**. The dialog box shown in Figure D-1 appears.

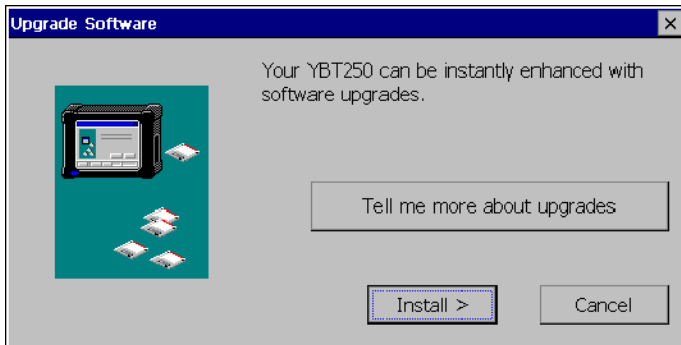

Figure D-1: The dialog displayed by selecting Tools>Upgrade Software

- a. To see which upgrades are installed or which upgrades are available, select **Tell me more about upgrades**. This displays the dialog shown in Figure D-2.

4. Select **Install with only a key** and then select **Next >** to continue with the upgrade.
5. Enter the Options key into the dialog box as shown in Figure D-4. To display the soft keyboard, tap the keyboard button to the right of the text entry box. After you enter the Options key, select **Next >**.

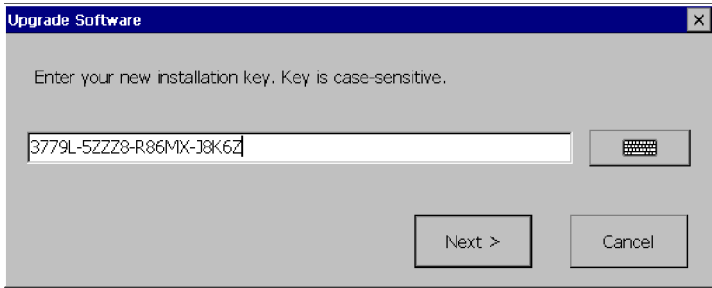

Figure D-4: Entering the Options key

After you select **Next >**, the software installation proceeds. When the installation is completed, the dialog box shown in Figure D-5 appears.

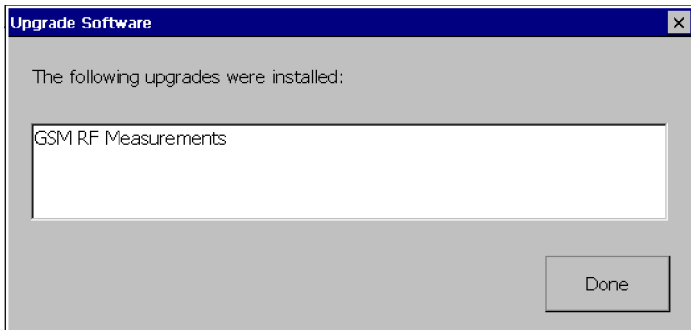

Figure D-5: Software installation is complete

6. Select **Done** to complete the software upgrade process.
7. If you received new software as part of an upgrade kit, place the label supplied in the kit on the bottom edge of your YBT250 module.

Upgrading/Reinstalling the YBT250 Software

On-screen installation instructions will guide you through upgrading or reinstalling the YBT250 software:

1. Insert the YBT250 Installation SW CD-ROM (Tektronix part number, 063-3476-XX) into your PC and follow the on-screen instructions that appear.
2. If no instructions appear after you insert the CD-ROM, use Windows Explorer to display the contents of the CD-ROM and double-click the setup.exe file to begin the installation. Follow the on-screen instructions.
3. If you received new software as part of an upgrade kit, place the label supplied in the kit on the bottom edge of your YBT250 module.

Appendix E: Functional Verification Procedure

This appendix provides a functional verification procedure. The procedure verifies the basic functionality of the YBT250. The functional verification procedure can be used for incoming inspection purposes.

NOTE. *The functional verification procedure in this appendix does not confirm that the YBT250 meets or exceeds the performance requirements for the specifications listed in Appendix A.*

There are two parts to this procedure:

- Self Tests: provides instructions for performing the internal diagnostic self-tests.
- Functional Tests: provides instructions for verifying capabilities not completely covered by the diagnostic self-tests. Requires the use of a signal generator.

Self Tests

Equipment Required

- None.

Prerequisite

- None.

To run the internal diagnostics self-tests:

1. Power up the NetTek Analyzer Platform.
2. Press **File>Exit** to quit the YBT250 application, if it is running.
3. Press **Start>Programs>Tektronix Utilities>Diagnostics** in the taskbar.

4. Tap the + box next to **All Modules, All Tests** to expand the selection tree.
5. Tap the check box next to **Platform** to deselect the platform diagnostics.
6. Verify that **Module 1: Digital** and **Module 1: Analog** are selected. See Figure E-1.

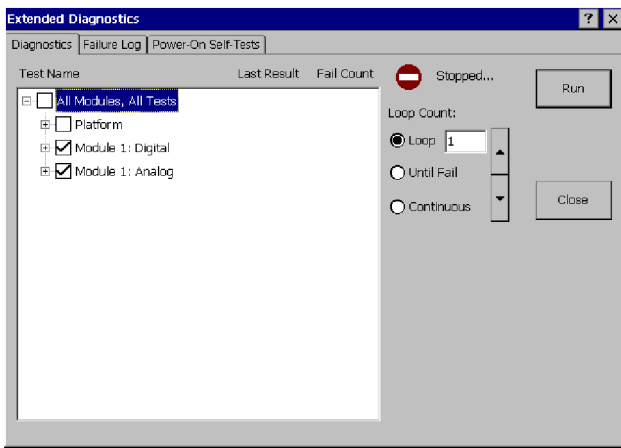

Figure E- 1: Settings to run diagnostics

7. Select **LOOP**, set the loop count to 1.
8. Tap **Run**.
9. Verify that each test executes and passes. *You will need to verify the audio tone output diagnostic by tapping the screen. The test will fail if you do not respond.*

NOTE. *If you encounter any errors, you can tap the Failure Log tab to display more information. If the YBT250 fails any of its diagnostic tests, contact your local Tektronix service representative.*

10. Tap **Close** to exit the diagnostic system.

Functional Tests

To perform the following tests, you must have an RF signal source.

Equipment Required

- One 50 Ω BNC cable, such as Tektronix part number 012-0057-01
- One BNC-female to N-male connector adapter, such as Tektronix part number 103-0045-00
- An RF signal generator with a 10MHz reference output, capable of generating a 100 MHz RF signal

Prerequisite



- None

NOTE. *These procedures verify only that the YBT250 is operating correctly. They do not verify that the YBT250 meets warranted specifications.*

Section 1: Check RF attenuation

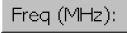

To check the RF attenuation:

1. Power up the NetTek Analyzer Platform.
2. If necessary, launch the YBT250 application by double-tapping the **YBT250** icon on the desktop or selecting **Start>Programs>NetTek>YBT250** from the Taskbar.
3. Power on the RF signal generator.
4. Set the RF signal generator to a 100 MHz, -30 dBm output level.
5. Connect the BNC female-N male adapter to the YBT250 RF INPUT connector.

6. Connect the BNC cable between the adapter on the RF INPUT connector and the signal generator output.
7. In the YBT250 application menubar, select **Tools>Factory Reset**. Tap **Reset All** in the pop-up dialog box.
8. Tap the **Freq (MHz)** button (). Using the numeric keypad, set the measurement frequency to 100 MHz.
9. Tap the **AutoLevel** button (). Verify that the signal appears on the center of the screen, with approximately -30 dBm amplitude.
10. Select **AMPS EIA 553** from the signal standard drop down list. (If AMPS EIA 553 doesn't appear in the list, select **More...** and then enable AMPS EIA 553.)
11. Tap the **Measure (1)** button to display the Measurements window. If the displayed measurement is not Channel Power, tap **Select Measurement**, then select the **RF Power** measurement.
12. Verify that the Channel Power is approximately -30 dBm.
13. Change the signal amplitude on the Signal Generator to 0 dBm.
14. Verify that the Channel Power measurement is approximately 0 dBm.
15. Change the signal amplitude on the Signal Generator to -70dBm
16. Verify that the Channel Power measurement is approximately -70dBm.
17. Disconnect the Signal Generator output from the YBT250.

Section 2: External Reference

To check the External Reference function:

1. Tap the **Measure** button ().
2. Tap **Select Measurement**. Tap **Carrier Freq** to display the Carrier Frequency measurement.
3. Verify the frequency reference icon (upper-right portion of the display) appears as  (F INT).

4. Verify that the External Reference Frequency measurement readout indicates “no signal” by displaying “-----”.
5. On your RF signal generator, set the external frequency to 10 MHz at 0 dBm.
6. Connect the external reference output of the signal generator to a 50 Ω BNC cable. Connect the cable to the FREQUENCY REFERENCE INPUT of the YBT250.

Upon connection, the YBT250 should display a window indicating it is acquiring the external reference. The window should disappear within 15 seconds.

7. Verify that the External Reference Frequency is 10.00000 MHz (bottom measurement on the screen).
8. Disconnect the Signal Generator output from the YBT250 Frequency Reference input.

This completes the Incoming Inspection procedure. If any errors occurred during this procedure, contact your local Tektronix service representative.

Appendix F: Supported Signal Standards

This appendix lists the signal standards on which measurements can be made by the YBT250.

Table F-1: Cellular standards supported

| Standard | Channel numbers |
|----------------------------------|---|
| US CDMA-Cellular | $1 \leq N \leq 799$ |
| TIA/EIA-95 | $990 \leq N \leq 1023$ |
| TIA/EIA-97C | |
| US CDMA-PCS | $1 \leq N \leq 1199$ |
| TIA/EIA-95 | |
| TIA/EIA-97C | |
| CDMA Korea-PCS | $1 \leq N \leq 599$ |
| CDMA Japan/ARIB | $1 \leq N \leq 799$ |
| | $801 \leq N \leq 1039$ |
| | $1041 \leq N \leq 1199$ |
| CDMA China-1 | $0 \leq N \leq 1000$ |
| | $1329 \leq N \leq 2047$ |
| CDMA China-2 | $0 \leq N \leq 1000$ plus $1329 \leq N \leq 2047$ |
| CDMA2000 Class 0, Korea Cellular | $1 \leq N \leq 799$ |
| | $990 \leq N \leq 1023$ |
| CDMA2000 Class 0, N. A. Cellular | $1 \leq N \leq 799$ |
| | $990 \leq N \leq 1023$ |
| CDMA2000 Class 1, N. A. PCS | $0 \leq N \leq 1199$ |
| CDMA2000 Class 2 (TACS Band) | $0 \leq N \leq 1000$ |
| | $1329 \leq N \leq 2047$ |
| CDMA2000 Class 3 (JTACS Band) | $1 \leq N \leq 799$ |

Table F-1: Cellular standards supported (Cont.)

| Standard | Channel numbers |
|---|---------------------------|
| | $801 \leq N \leq 1039$ |
| | $1041 \leq N \leq 1199$ |
| | $1201 \leq N \leq 1600$ |
| CDMA2000 Class 4, Korea PCS | $0 \leq N \leq 599$ |
| CDMA2000 Class 5, (NMT-450W 25 kHz) | $1 \leq N \leq 300$ |
| | $539 \leq N \leq 871$ |
| CDMA2000 Class 5, (NMT-450N 20 kHz) | $1039 \leq N \leq 1473$ |
| | $1792 \leq N \leq 2016$ |
| CDMA2000 Class 6, IMT-2000 | $0 \leq N \leq 1199$ |
| CDMA2000 Class 7, N. A. 700 MHz Cell Band | $0 \leq N \leq 359$ |
| W-CDMA | $9601 \leq N \leq 9899$ |
| | $10551 \leq N \leq 10849$ |
| NADC IS-136 Cellular | $1 \leq N \leq 799$ |
| | $990 \leq N \leq 1023$ |
| NADC-PCS / IS-136 | $1 \leq N \leq 1999$ |
| GSM/EDGE 450 | $259 \leq N \leq 293$ |
| GSM/EDGE 480 | $306 \leq N \leq 340$ |
| GSM/EDGE 850 | $128 \leq N \leq 251$ |
| GSM-E/EDGE 900 | $0 \leq N \leq 124$ |
| | $975 \leq N \leq 1023$ |
| GSM-P/EDGE 900 | $1 \leq N \leq 124$ |
| GSM-R/EDGE 900 | $0 \leq N \leq 124$ |
| | $955 \leq N \leq 1023$ |
| GSM/EDGE 1800 | $512 \leq N \leq 885$ |
| GSM/EDGE 1900 | $512 \leq N \leq 810$ |
| AMPS / EIA 553 | $1 \leq N \leq 799$ |

Table F-1: Cellular standards supported (Cont.)

| Standard | Channel numbers |
|------------------|--|
| | $990 \leq N \leq 1023$ |
| N-AMPS / IS-88 | $1 \leq N_M \leq 799$ |
| | $990 \leq N_M \leq 1023$ |
| | $1 \leq N_L \leq 799$ |
| | $990 \leq N_L \leq 1023$ |
| | $1 \leq N_U \leq 799$ |
| | $990 \leq N_U \leq 1023$ |
| TACS | $1 \leq N \leq 1000$ |
| ETACS | $0 \leq N \leq 1000$ |
| | $1329 \leq N \leq 2047$ |
| NTACS | $1 \leq N \leq 799$ |
| | $800 \leq N \leq 1039$ |
| | $1040 \leq N \leq 1199$ |
| JTACS | $0 \leq N \leq 798$ (even chan. only) |
| | $800 \leq N \leq 1038$ (even chan. only) |
| | $1040 \leq N \leq 1198$ (even chan. only) |
| | |
| NMT-411-25 kHz | $539 \leq N \leq 871$ |
| NMT-450-25 kHz | $1 \leq N \leq 300$ |
| NMT-450-20 kHz | $1039 \leq N \leq 1473$ |
| NMT-470-20 kHz | $1792 \leq N \leq 2016$ |
| NMT-900 | $1 \leq N \leq 1000$ |
| NMT-900 (offset) | $1025 \leq N \leq 2023$ |
| MATS-E | $1 \leq N \leq 1000$ |

Table F-1: Cellular standards supported (Cont.)

| Standard | Channel numbers |
|---|-------------------------|
| C-450 (SA) | $1 \leq N \leq 247$ |
| C-450 (P) | $1 \leq N \leq 800$ |
| CDMA2000 1xEVDO Class 0 NA Cellular | $1 \leq N \leq 799$ |
| | $990 \leq N \leq 1023$ |
| CDMA2000 1xEVDO Class 0 Korea | $1 \leq N \leq 799$ |
| | $990 \leq N \leq 1023$ |
| CDMA2000 1xEVDO Class 1 N.A. PCS | $0 \leq N \leq 1199$ |
| CDMA2000 1xEVDO Class 2 TACS Band | $0 \leq N \leq 1000$ |
| | $1329 \leq N \leq 2047$ |
| CDMA2000 1xEVDO Class 3 JTACS Band | $1 \leq N \leq 799$ |
| | $801 \leq N \leq 1039$ |
| | $1041 \leq N \leq 1199$ |
| | $1201 \leq N \leq 1600$ |
| CDMA2000 1xEVDO Class 4 Korea PCS | $0 \leq N \leq 599$ |
| CDMA2000 1xEVDO Class 5 NMT-25k-450 | $1 \leq N \leq 300$ |
| | $539 \leq N \leq 871$ |
| CDMA2000 1xEVDO Class 5 NMT-20k-450 | $1039 \leq N \leq 1473$ |
| | $1792 \leq N \leq 2016$ |
| CDMA2000 1xEVDO Class 6 IMT-2000 | $0 \leq N \leq 1199$ |
| CDMA2000 1xEVDO Class 7 N.A. 700 MHz Cellular | $0 \leq N \leq 359$ |
| CDMA2000 1xEVDO Class 8 GSM Band | $0 \leq N \leq 1499$ |
| CDMA2000 1xEVDO Class 9 GSM Band | $0 \leq N \leq 699$ |

Appendix G: Channel Table

You can generally find the contents of the standard Channel Table file by following this path on the NetTek Analyzer:

```
\BuiltInDisk\NetTekApps\YBT250\SignalStandards.txt
```

However, if the application is not loaded into the BuiltInDisk directory due to lack of space, you can also find the standard Channel Table file on this path:

```
\NetTekApps\YBT250\SignalStandards.txt
```

This file can be opened online as a text file (with Pocket Word); however, for the easiest viewing, copy the file to a PC and use Excel to view it.

For instructions on how to create a custom version of the channel table, see page 2-40.

About the Signal Type

The Channel Table file contains a field that defines the type of signal for the named signal standard. For example, the standard named GSM 900 is designated as a Signal Type 4. The Signal Type is used by the Signal Identification function to suggest possible sources of interference.

Although the YBT250 will make measurements only on the first six signal types listed in Table 2-12, you can define a signal standard that is based on other signal types. For example, you could create an FM signal standard of signal type 998 (Analog signal, no measurements available) and define channels within the FM radio band. This would allow you to tune to “channels” within the FM band, although you could not take measurements with the YBT250.

The reason for creating a signal standard is that the Signal Identification function uses the Channel Table to determine possible types of signals, and if you have defined a signal standard, then it will appear as a possible source in the signal Identification function.

The signal types 998 and 999 are included in the Channel Table to enable you to create a custom signal standard for analog or digital signals that do not match the other signal types (such as an “FM” standard noted previously). Though no measurements would be made on channels of a standard based on either 998 or 999, the standard they are assigned to would be used by the Signal Identification function.



Glossary

Glossary

ACLR. Adjacent Channel Leakage power Ratio (ACLR) is the ratio of the RRC (Root Raised Cosine) filtered mean power centered on the assigned channel frequency to the RRC filtered mean power centered on an adjacent channel frequency.

BMP - Graphics File Format. BMP is one of the file formats available for saving screen captures. BMP is the standard Windows graphic image format. The filename extension is “bmp”.

BTS. Acronym for Base Transceiver Station.

Burst Power. Burst Power is a measurement of the average power in a burst of RF power on a GSM signal.

Carrier Feedthrough. Carrier Feedthrough is the offset of the constellation from zero power. It is measured relative to the full power carrier.

Channel Power. Channel Power is the RF Power measured on the selected channel.

Codogram. The Power Codogram displays a series of sequential code domain power measurements where color represents amplitude and the vertical axis represents time.

Code Domain Power. Code Domain Power is a measurement of the power in each Walsh code.

Difference. Difference is the power difference between Channel Power and the Ref Power.

Error Vector Magnitude (EVM). Error Vector Magnitude is the RMS value of all the vectors that extend from the ideal constellation points to the received signal constellation points in a record of demodulated CDMA symbols, divided by the RMS value of the signal. This result is multiplied by 100 to give a final value in percent.

Flash Memory. Flash memory is a form of non-volatile memory. When the YBT250 software is stored in flash memory, the YBT250 loads more quickly at power on.

FM Deviation. FM Deviation is the maximum one-sided frequency deviation of the carrier due to modulation. The measurement displays whichever is greatest of either the positive or negative deviation.

Forward Frequency. The frequency the base station uses to transmit to the mobile unit. Also called Downlink Frequency.

Frequency Marker. The frequency marker indicates the Measurement Frequency setting. The Measurement Frequency is the frequency at which measurements are made. The frequency marker appears on the display as a small triangle at the bottom of a trace display and a circle on the trace itself. Changing the frequency marker location, by tapping a new location on the display or entering a new Channel number or frequency, changes the Measurement Frequency.

Frequency Error. Frequency Error is the difference in frequency between the measured frequency of the selected channel and the frequency assigned to the channel in the channel table.

JPEG - Graphics File Format. JPEG, an acronym for Joint Photographic Experts Group, is one of the file formats available for saving screen captures. Files saved in JPEG format can be much smaller in size than files saved in BMP format. The filename extension is “jpg”.

Measurement Frequency. The Measurement Frequency is the frequency at which measurements are made. The Measurement Frequency is always shown in the Frequency box. The Measurement Frequency is indicated in the spectrum displays by the frequency marker.

Measured Frequency. The actual frequency measured for the selected channel.

Noise Floor. Noise Floor measures the interference coming into the receiver antenna. The Noise Floor is an integrated power measurement for the selected standard. Larger numbers indicate more noise.

Occupied Bandwidth. The Occupied Bandwidth is the frequency range where 99% of the power transmitted in a single channel lies. If there is a signal in either channel adjacent to the selected channel, the signal will add power to the measurement, thus resulting in an inaccurate measurement.

Peak-to-Average Power. The Peak-to-Average Power measurement is the ratio of the peak envelope power in the transmitted signal to the average power in the transmitted signal. The ratio is expressed in dB.

Pilot Power. The Pilot Power is the absolute power of the pilot channel (Walsh Code 0) in a CDMA channel. For W-CDMA, the Pilot Power is the absolute power of the Primary Common Pilot Channel (P-CPICH). The primary common pilot channel is used as a phase reference for many channels and to identify the primary scrambling code.

Pilot Time Alignment Error (Tau). The Pilot Time Alignment Error is the difference in timing between the pseudo noise (PN) sequences and the CDMA system time.

PN Offset. PN Offset is the “coarse” timing difference between the pilot channel and the even-second clock.

PNG - Graphics File Format. PNG, an acronym for Portable Network Graphics, is one of the file formats available for saving screen captures. PNG is a new format developed primarily for use on the World Wide Web. PNG files are usually much smaller than BMP files. The filename extension is “png”.

RF Channel Power. RF Channel Power is the total RF power in the selected channel. This measurement assumes a 50 ohm nominal impedance.

Reference Level. The power level at the top of a spectrum window.

Reverse Frequency. The frequency the mobile unit uses to transmit to the base station. Also called uplink frequency, reverse channel or uplink channel.

Scrambling Code. There are 512 primary scrambling codes available in a W-CDMA system, numbered from 0 to 511, which are used to uniquely identify each downlink signal. All code channels in a downlink signal, with the exception of the primary (P-SCH) and secondary (S-SCH) synchronization channels, are scrambled by either the primary scrambling code, or one of the 15 secondary scrambling codes associated with each primary scrambling code. The YBT250 decodes only the primary scrambling code of each signal, not the secondary scrambling codes.

Span. Sets the frequency range covered by the spectral display graph. The YBT250's resolution bandwidth (RBW) is automatically adjusted based on the span setting.

Waveform Quality (Rho). The Waveform Quality measurement is an indication of the quality of the transmitted signal. Rho can vary between 0.0 and 1.0, where 1.0 represents a perfect signal. True Waveform Quality is defined as an out-of-service measurement where the base station is transmitting only a pilot signal. If additional channels are active, an Estimated Rho is displayed.



Index

Index

A

- Absolute RF power mode, 3-70
- Accessories, B-1
- ACLR, measuring, 3-118
- Address, Tektronix, xiii
- Audible tone, 3-40
- Auto saving and exporting, setting
 - default location for files, 2-49
- Average, trace type, 3-6

B

- Band Edge Cursor, 3-22
 - View menu, 2-18
- BATTERIES indicator, 2-2
- Battery
 - installing, 1-6
 - removing, 1-10
- Battery life, A-23
- Beep indicator, 3-40
- Both on front trace, 3-21
 - View menu, 2-18
- Both on Trace 1/2, 3-21
 - View menu, 2-18
- Buttons
 - command bar area, 2-12
 - help, 2-4
 - Interference window, 3-36
 - Measure window, 3-52
 - program, 2-6
 - rotate traces, 3-13
 - shared control area, 2-11
 - Spectrum window, 3-2
 - tuning control area, 2-13

C

- C/I (GSM/EDGE), measuring, 3-91
- Calibration interval, A-23
- Carrier Feedthrough, measuring, 3-85, 3-86, 3-88
- Carrier Frequency, measuring, 3-81
- Cellular standards supported, F-1
- Certifications, A-24
- Channel table
 - channel wizard, 2-38
 - contents of, G-1
 - customizing, 2-40
 - setting, 2-36
 - signal type, 2-44, G-1
- Clear All Channels button, 2-38
- Code Power, measuring
 - cdma2000, 3-95
 - cdmaOne, 3-93
- Code Power readout, 3-97
- Codogram
 - Auto Save, 3-112
 - displaying, 3-104
 - cdma2000, 3-106, 3-108
 - cdma2k 1xEV-DO, 3-110
 - printing, 3-113
- Compare Saved command, 3-15
 - File menu, 2-16, 2-17
- Comparing traces, 3-13
- Connecting RF signals, 2-24
- Connectors, input, 2-3
- Contacting Tektronix, xiii
- Controls, front panel, 2-2

Conventions, xii
Coordinates, saving GPS data,
2-50

D

Data Code Power Min and Max ,
Code Domain Power readout,
3-104
Daughter readout, 3-97
Default file type, setting the, 2-48
Define Mask, View Menu, 2-18
Define Trace 2, View Menu, 2-18
Define Trace 2 tab, 3-13
Description, product, 1-1
Desktop
icons, 2-6, 2-7
overview, 2-5
program button, 2-6
Start menu, 2-6
status area, 2-7
taskbar, 2-6
Difference, 3-65
Dimensions, external, A-22
Disabling tap/drag, 3-11
Display, preferences, 2-35
Displaying, saved traces, 3-13

E

Ec scrambling code, (Opt WS1),
3-48
Ec/Io scrambling code, (Opt WS1),
3-48
Edit command, Setup menu, 2-19
Enabling signal standards, 2-33
Enabling tap/drag, 3-11
Environmental specifications,
A-24

Error marking in Spectrogram,
3-25
Error Vector Magnitude
measuring, 3-85, 3-86, 3-88
cdma2k 1xEV-DO, 3-88
measuring (GSM/EDGE), 3-91
Exit command, File menu, 2-16,
2-17
Export Results As command, File
menu, 2-16
Export Screen As command, File
menu, 2-16, 2-17
Export Trace As command, File
menu, 2-17
Exporting
results, 3-127
screens, 3-128
traces, 3-131

F

Factory Reset command, Tools
menu, 2-19
File menu, 2-16, 2-17
File options, setting, 2-45
Filename length, 2-47
Filename prefix, setting, 2-46
Find information, start Help, 2-4
Frequency Correction, 2-29
Tools menu, 2-19
FREQUENCY REFERENCE
INPUT connector, 2-3, 2-26
Front-panel controls, 2-2
Functional verification, E-1

G

Global ID, displaying, D-1
GPS receiver set up, 2-50

GSM/EDGE

- Absolute RF power mode, 3-70
- BCCCH Frame Sync, 3-67
- Power vs. Time graph units, 3-79
- Relative RF power mode, 3-70

H

- Hardware Info command, Tools menu, 2-20

Help

- find information, 2-4
- icons, 2-4

- Hide program, 2-6

- Horizontal position, setting, 3-10

I**Icons**

- ?, 2-4
- command bar area, 2-12
- desktop, 2-6, 2-7
- Interference window, 3-36
- Measure window, 3-52
- shared control area, 2-11
- Spectrum window, 3-2
- status, 2-7
- tuning control area, 2-13

- IN1, option, 3-35

- Incoming inspection, E-1

- Information, getting help, 2-4

- Input connectors, 2-3, 2-23, 2-26

- Input Overrange marking in Spectrogram, 3-25

- Input panel, enter keyboard characters, 2-20

Installing

- shoulder strap, 1-16

- strand hook, 1-16

- YBT250 module, 1-3

Interference

- identifying, 3-38
- locating, 3-35

- Interference Analyst, (Option IN1), 3-35

- Intermittent interference, locating, 3-44

- Io scrambling code, (Opt WS1), 3-48

K

- Keyboard, (soft) input panel, 2-20

- Keyboard command, Tools menu, 2-19

Knob

- button, 2-11
- using, 2-14

L**Limit test measurements**

- Analog, 3-56
- cdma2k 1xEV-DO, 3-58
- cdmaOne/cdma2000, 3-56
- GSM, 3-56
- GSM/EDGE, 3-57
- NADC IS-136, 3-57
- W CDMA, 3-57

- Locating intermittent signals, 3-44

- Location data, saving GPS coordinates, 2-50

- Location for auto saving files, 2-49

- Lock-up, recovering from, 2-2

- Locking scrambling codes, (Opt WS1), 3-48

M

M1 Trace 1, M2 Trace 2, 3-21

View menu, 2-18

MAC Code Power, Code Domain

Power readout, 3-103

MAC Index, Code Domain Power

readout, 3-103

Mark All Channels button, 2-37

Marker Code Domain Power

readout, 3-100

Markers

Both on front trace, 3-21

Both on Trace 1/2, 3-21

M1 Trace 1, M2 Trace 2, 3-21

measuring frequency and level,

3-20, 3-21

readouts, 3-18

specifying units, 3-19

View menu, 2-18

viewing, 3-17

Mask, View Menu, 2-18

Max Hold, trace type, 3-7

Measurement frequency, 3-52,

3-53

Measurements, available, 3-55

Measuring

ACLR, 3-118

C/I (GSM/EDGE), 3-91

Carrier Feedthrough, 3-85, 3-86,

3-88

carrier frequency, 3-81

cdma2000 code power, 3-95

cdmaOne code power, 3-93

Error Vector Magnitude, 3-85,

3-86, 3-88

cdma2k 1xEV-DO, 3-88

Error Vector Magnitude (GSM/

EDGE), 3-91

occupied bandwidth, 3-83

Origin Offset (GSM/EDGE),
3-91

Peak to Average Power Ratio,
3-80

pilot power, 3-115, 3-117

Pilot Time Alignment, 3-85

PN Offset, 3-85

Power vs. Time (GSM/EDGE),
3-76

RF Channel Power (GSM/
EDGE), 3-65

RF Power, 3-63

cdma2000 1xEV-DO, 3-72

Scrambling Code, 3-86, 3-88

signal quality, 3-85, 3-86

cdma2k 1xEV-DO, 3-88

GSM/EDGE, 3-91

Waveform Quality (Rho), 3-85

Menus

File, 2-16, 2-17

Help, 2-4

Setup, 2-19

Start, 2-6

Tools, 2-19

View, 2-18

Min Hold, trace type, 3-6

Min/Max Hold, trace type, 3-7

Mother Code Domain Power

readout, 3-97

N

No scrambling code, (Opt WS1),
3-48

Normal, trace type, 3-6

Notes, entering, 2-47

Numeric keypad, using, 2-14

O

Open command

File menu, 2-16, 2-17

Setup menu, 2-19

Option

IN1, 3-35

WS1, 3-47

Optional accessories, B-2

Options, C-1

Options

installed, D-2

installing, D-1

Options command, Tools menu,
2-19

Options key, displaying, D-2

Origin Offset, measuring (GSM/
EDGE), 3-91

OVSF Code Domain Power read-
out, 3-100

P

Path for auto saving files, 2-49

Peak to Average Power Ratio,
measuring, 3-80

Phone number, Tektronix, xiii

Pilot power, measuring, 3-115,
3-117

Pilot Time Alignment, measuring,
3-85

PN Offset

Code Domain Power readout,
3-97, 3-103

measuring, 3-85

Power Code Domain Power read-
out, 3-100

Power off, analyzer, 2-21

Power switch, 1-20, 2-2

Power vs. Time (GSM/EDGE),
3-76

measuring, 3-76

Setting graph units, 3-79

Preferences tab, 2-35

Preset command, Setup menu,
2-19

Print command, File menu, 2-16,
2-17

Product description, 1-1

Product support, contact informa-
tion, xiii

Program button, 2-6

Q

Quick Select List, 2-37

R

Recalling a trace, 3-130

Recalling results, 3-125

Recalling setups, 3-134

Red marking in Spectrogram, 3-25

Ref Power, 3-65

Reference level, setting, 3-11

Relative RF power mode, 3-70

Removing, a battery, 1-10

Removing, a module, 1-6

Reset

hardware, 2-2

software, 1-19, 2-22

switch, 2-2

Results

exporting, 3-127

recalling, 3-125

saving, 3-124

- Results Properties command, File menu, 2-16, 2-17
- RF Channel Power (GSM/EDGE)
 - Absolute, 3-70
 - BCCH Frame Sync, 3-67
 - measuring, 3-65
 - Relative, 3-70
- RF INPUT connector, 2-3
- RF Power, measuring, 3-63
 - cdma2000 1xEV-DO, 3-72
- Rho, measuring, 3-85
- Rotate Trace Order, View menu, 2-18
- Rotate traces button, 3-13
- RSCP scrambling code, (Opt WS1), 3-48
- RSSI scrambling code, (Opt WS1), 3-48

S

- Save & Export tab, 2-46
- Save command, Setup menu, 2-19
- Save Results command, File menu, 2-16
- Save Results As command, File menu, 2-16
- Save Trace command, File menu, 2-17
- Save Trace As command, File menu, 2-17
- Saved trace, displaying, 3-13
- Saving
 - GPS coordinates, 2-50
 - location for auto saving files, 2-49
 - results, 3-124
 - setting default file types, 2-48
 - setting up defaults, 2-45
 - traces, 3-129

- Scr Code tab, (Opt WS1), 3-47
- Scrambling Code
 - Domain Power readout, 3-100
 - measuring, 3-86, 3-88
 - Scrambling Code Analyzer, (Opt WS1), 3-47
 - setting, 3-61
- Screens
 - exporting, 3-128
 - file formats, 3-132
- Serial number, displaying, D-1
- Service support, contact information, xiii
- Setting
 - channel table, 2-36
 - codogram Auto Save, 3-112
 - display colors, 2-35
 - file options, 2-45
 - filename prefix, 2-46
 - horizontal position, 3-10
 - measurement frequency, 3-52
 - note text, 2-47
 - reference level, 3-11
 - spectrogram Auto Save, 3-26
 - spectrogram update rate, 3-25
 - startup application, 2-9
 - technician name, 2-47
 - trace type, 3-6
 - vertical position, 3-10
 - vertical scale, 3-9
- Setup Menu, customizing, 3-135
- Setup menu, 2-19
- Setups
 - recalling, 3-134
 - saving, 3-133
- Shoulder strap, 1-16
- Shutdown, analyzer power, 2-21

Signal quality, measuring, 3-85,
3-86
cdma2k 1xEV-DO, 3-88
GSM/EDGE, 3-91

Signal standards
enabling, 2-33
supported, F-1

Signal type, in channel table, 2-44

Software
load process, 1-17
reset, 2-22
upgrading, D-1
version, xii

Software Info, Tools menu, 2-20

Software Options, Options, D-1

Sorting scrambling codes, (Opt
WS1), 3-48

Specifications, A-1
environmental, A-22, A-24

Spectrogram
Auto Save, 3-26
displaying, 3-24
update rate, 3-25

Spectrogram overload marking,
3-25

Standard accessories, B-1

Standby mode, 2-21

Start menu, 2-6

Startup application, setting, 2-9

Status
area, desktop, 2-7
icons, 2-7

STATUS indicator, 2-2

Strand hook, 1-16

Strength indicator, 3-40

Suspend, analyzer activity, 2-21

Suspend mode, 1-18

Symbol Rate Code Domain Power
readout, 3-97, 3-100

symbols, 3-79

T

Tap/drag action icon, 3-11

Taskbar, desktop, 2-6

Technical support, contact informa-
tion, xiii

Technician name, setting, 2-47

Tektronix, contacting, xiii

Tilt stand, 1-14

TIMING INPUT connector, 2-3,
2-26

Tools menu, 2-19

Touchscreen
calibration, 1-18
calibration command, Tools
menu, 2-19

Trace
exporting, 3-131
recalling, 3-130
saving, 3-129

Trace 2, View Menu, 2-18

Trace display options, 3-14

Trace2, 3-13

Troubleshooting, GPS receiver,
2-51

Type Code Domain Power readout,
3-97, 3-100

U

Unlocking scrambling codes,
(Opt WS1), 3-48
Updates..., 3-25
Upgrade Software command, Tools
menu, 2-19
Upgrading software, D-1
URL, Tektronix, xiii

V

Vertical position, setting, 3-10
Vertical Scale, 3-9
View menu, 2-18
vxHpc, 2-52

W

Waveform Quality, measuring,
3-85
Web site address, Tektronix, xiii
Weight, A-22
WS1, option, 3-47